

Situatie bijlage 50
 Geschematiseerd lengte profiel .. 51 en 52
 Dwarsprofielen .. 53 m. 61

Situatie bijlage 37
 Geschematiseerd lengte profiel .. 38
 Dwarsprofielen .. 39 m. 41

Situatie bijlage 42
 Geschematiseerd lengte profiel .. 43
 Dwarsprofielen .. 44 m. 49

Situatie bijlage 32
 Geschematiseerd lengte profiel .. 33
 Dwarsprofielen .. 34 m. 36

Situatie bijlage 16
 Geschematiseerd lengte profiel .. 17 en 18
 Dwarsprofielen .. 19 m. 31

Situatie bijlage 3
 Geschematiseerd lengte profiel .. 4 en 5
 Dwarsprofielen .. 6 m. 15

TOELICHTING

1 km verdeling
 — poldergrens
 — betonnenmuur

TEKORTEN IN DIJKSHOOGTEN

— > 100 cm.
 — 100-80 cm.
 — 80-60 cm.
 — 60-40 cm.
 — 40-20 cm.
 — 20-0 cm.

— Lijn van den duivoet
 — G.H.W.
 — G.L.W.
 — 5 — Sm-N.A.P.
 — 10 — 10 m.
 — 20 enz. — Dieptelijnen in m-N.A.P.

GEBEZIGDE GEGEVENS

Opnamen Hydrografische dienst 1928-1940
 R.W. Strandmetingen 1938-1939
 Topografische dienst

AFKORTINGEN

H.K. Herv. Kerk R.C.K. R.C. Kerk G.K. Geref. Kerk
 W.T. Waterloren M. Molen

BENAMINGEN

Cursief Banken platen en schorren
 Verticaal Eilanden, plaatsen en geulen

RIJKSWATERSTAAT - DIR. BENEDENRIVIEREN

ZEELAND

OVERZICHT VAN DE ZEEUWSCHE HOOFDWATERKEERINGEN

OPN. D.D. PAR. GET. D.D. 11-6-46 GEZ. D.D. 12-6-46
 D.D. PAR. N.S. D.D. PAR. N.S.

SCHAAL 1:100.000 IN BLADEN BULAGE 2
 K.N. BLAD N. S. REG. N. S. 4713

FORM. C3

SITUATIE ZEEUWSCH VLAANDEREN

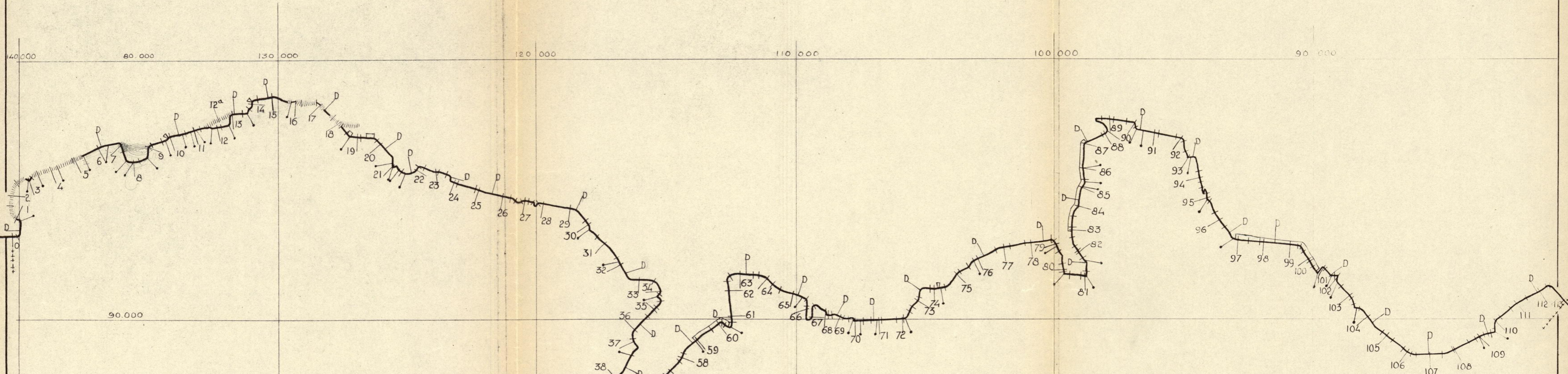

- TOELICHTING**
-  km - VERDEELING
 -  OVERGENOMEN DWARSPROFIEL
 -  DW. PR. ELDERS AANWEZIG
 -  POLDERGRENS
 -  BETONMUUR
- SCHAAL 1:100.000**

GEM. DIJKSKRUINHOOGTE PER k.m.

ZEEUWSCH VLAANDEREN (WEST)

WATERPASSING 1918 EN 1919
HERZIEN 1923, BUGEWERKT TOT JAN 1943

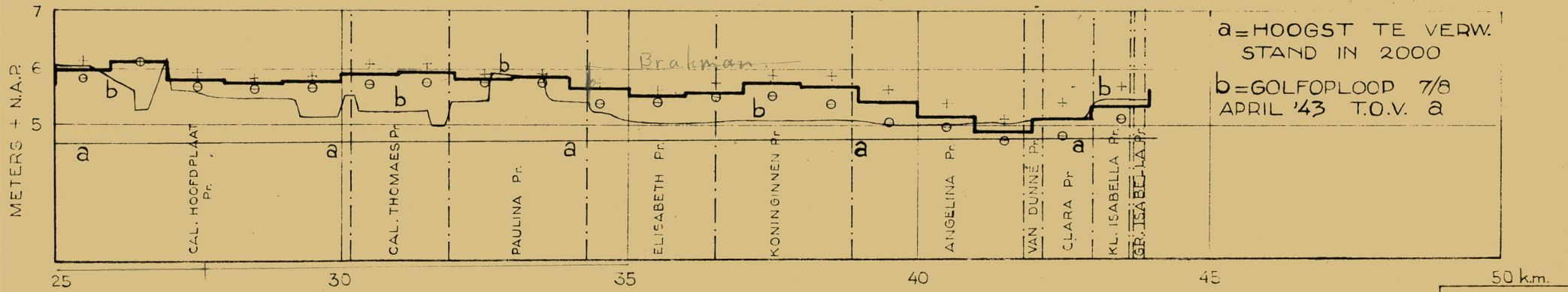
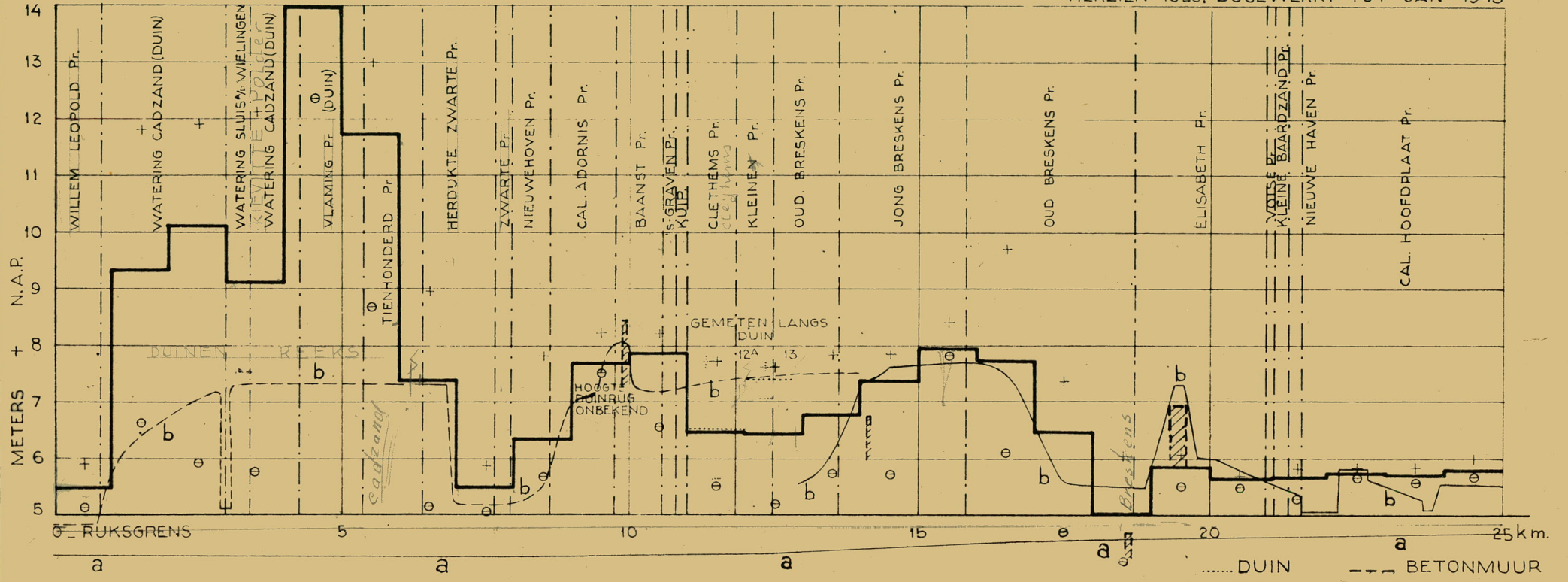

BULAGE

GEM. DIJKSKRUINHOOGTE PER k.m.

ZEEUWSCH VLAANDEREN (OOST)

WATERPASSING 1918 EN 1919
HERZIEN 1923, BIJGEWERKT TOT JAN 1943

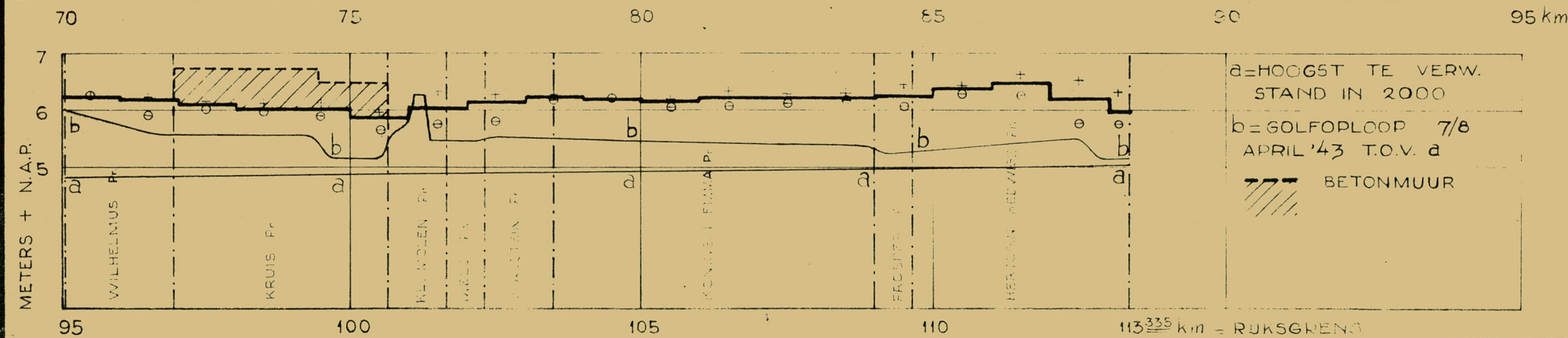
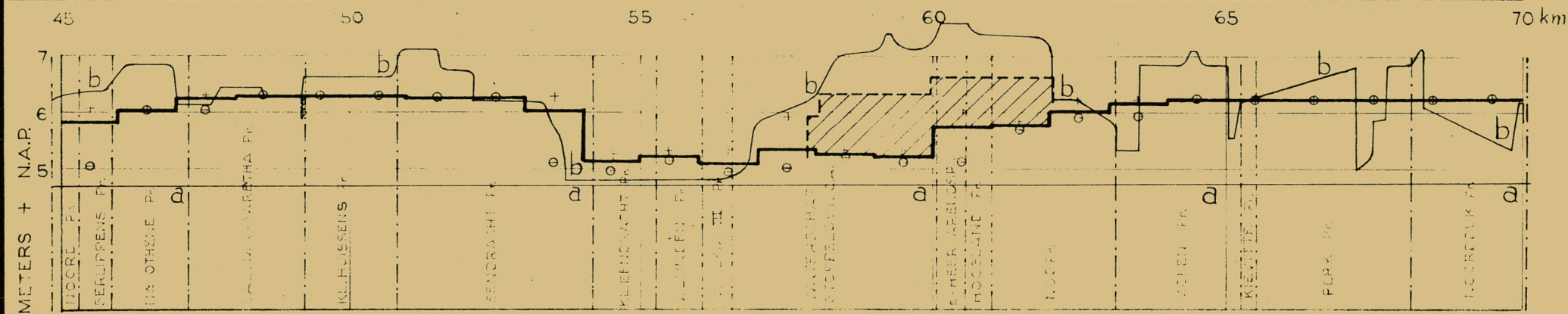
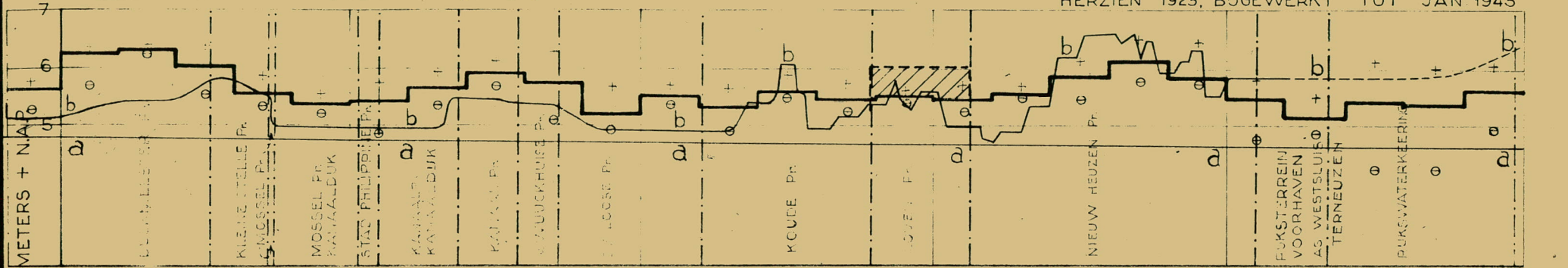

a = HOOGST TE VERW. STAND IN 2000
b = GOLFOOPLOOP 7/8 APRIL '43 T.O.V. a
BETONMUUR

113.335 km = RUKSGRENS

BULAGE

DWARSPROFIELEN ZEEUWSCH VLAANDEREN (1)

SCHAAL 1:200

Pr. WILLEM LEOPOLD

505 m. UIT BEGIN, km. 0⁴⁹⁰

HW. = 1.77 m. + N.A.P.

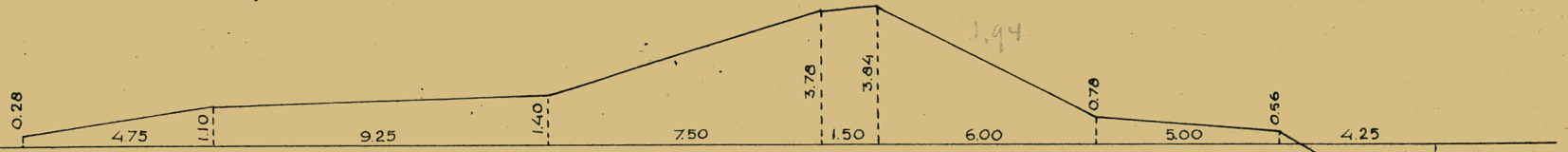

TIENHONDERDP.

810 m. UIT BEGIN, km. 6¹⁷⁰

HW. = 1.77 m. + N.A.P.

20.00

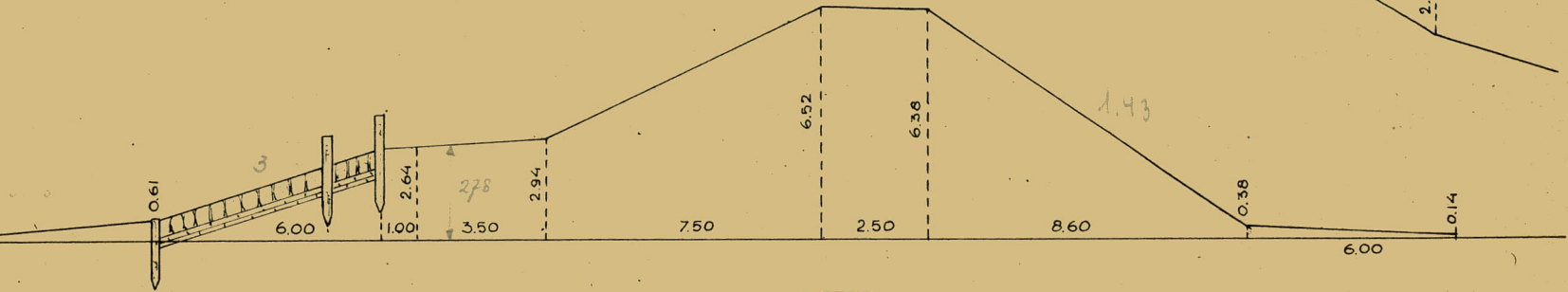

BAANSTP.

D.P. 6 - km. 10³²⁰

HW. = 1.77 m. + N.A.P.

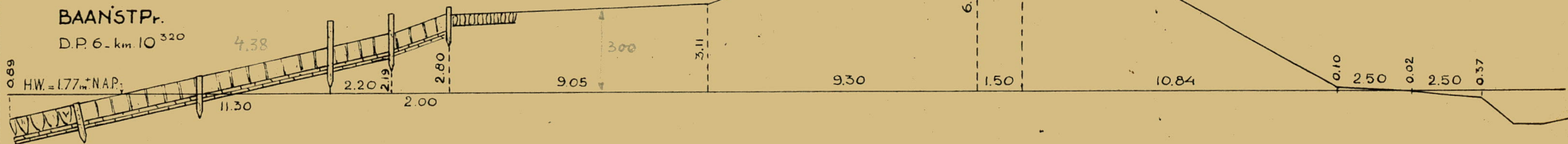

W. OUD EN JONG BRESKENS

D.P. 6 - km. 13⁰⁵⁰

HW. = 1.84 m. + N.A.P.

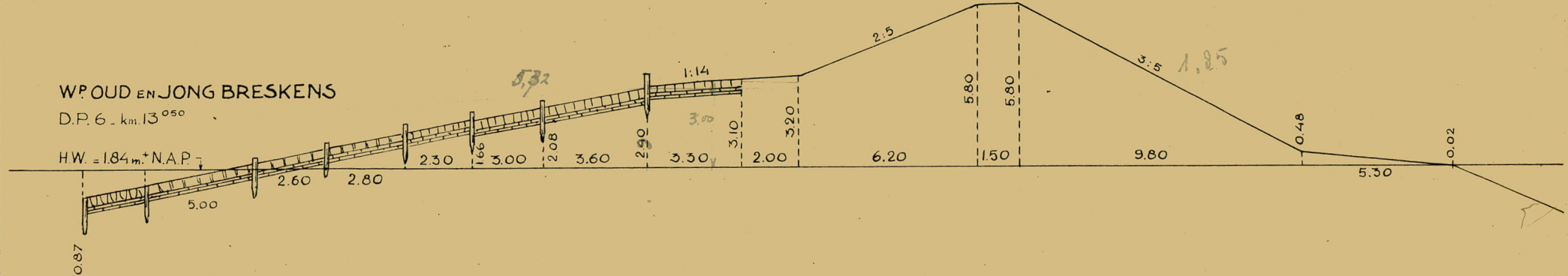

BIJLAGE 6

DWARSPROFIELEN ZEEUWSCH VLAANDEREN (2)

SCHAAL 1:200

WP OUD EN JONG BRESKENS

D.P. 24 - km 14⁸⁵⁰

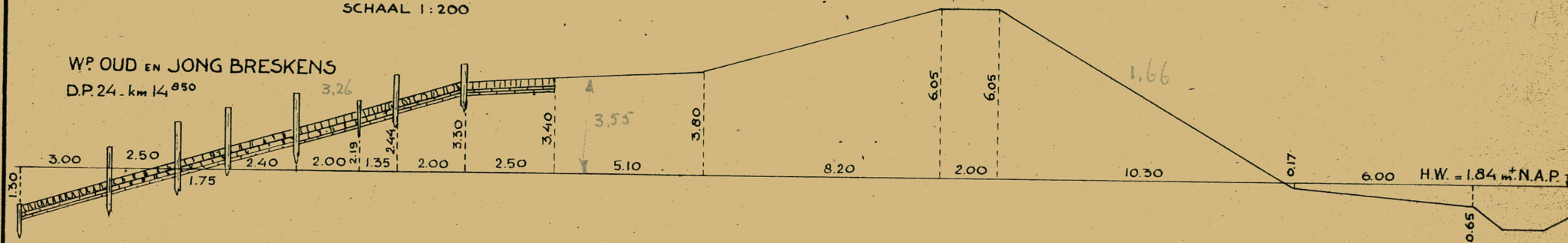

WP OUD EN JONG BRESKENS

19.30 m. VOORBUJ D.P. 48 - km. 17²⁶⁵

H.W. = 1.84 m + N.A.P.

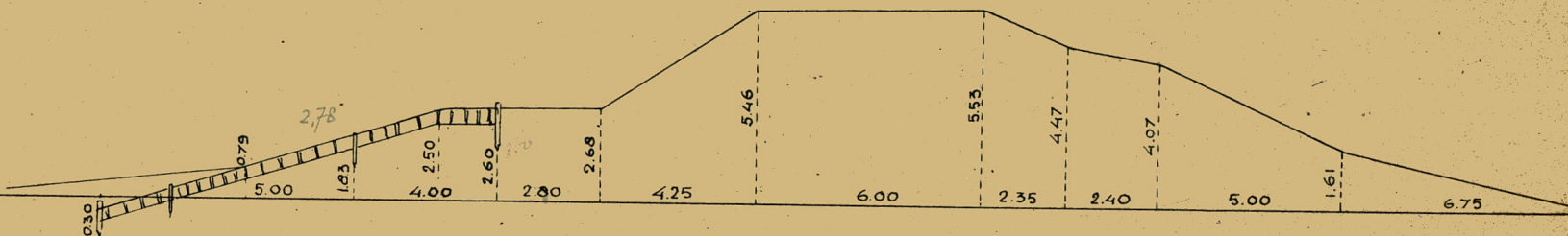

ELISABETH Pr.

D.P. 16 - km. 20²⁸⁰

H.W. = 1.84 m + N.A.P.

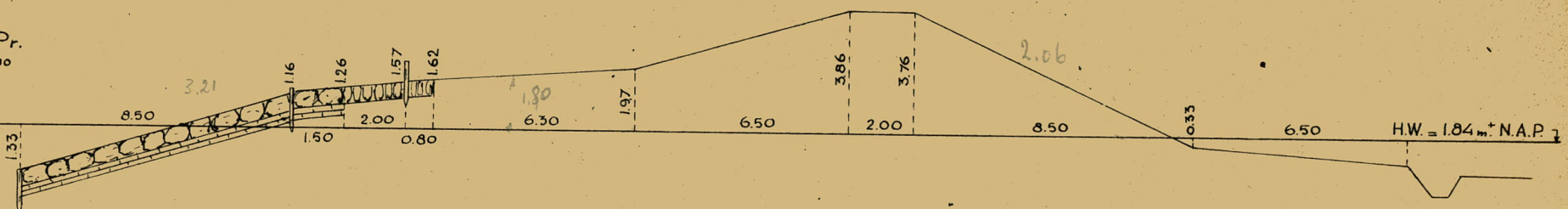

HOOFDPLAAT Pr.

D.P. 2 - km. 21⁷⁶⁰

H.W. = 1.89 m + N.A.P.

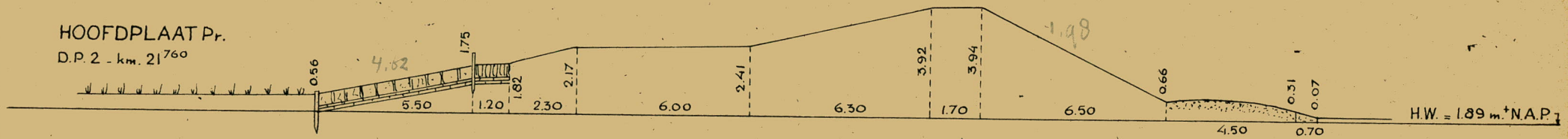

BYLAGE 7

DWARSPROFIELEN ZEEUWSCH VLAANDEREN (3)

SCHAAL 1: 200

HOOFDPLAAT Pr.

D.P. 22 - km. 23⁶⁶⁰

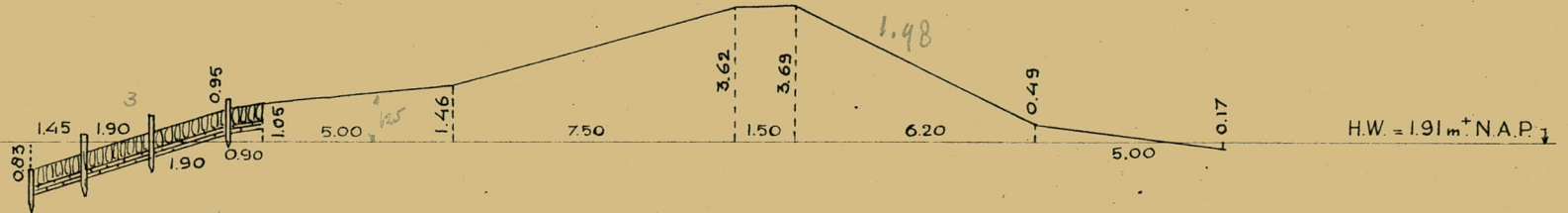

HOOFDPLAAT Pr.

D.P. 41 - km. 25⁵⁷⁰

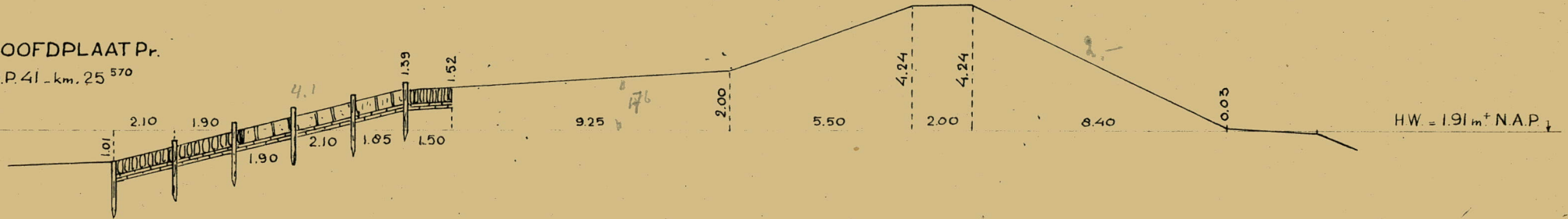

HOOFDPLAAT Pr.

15 m. VOOR D.P. 78 - km. 29²⁵⁰

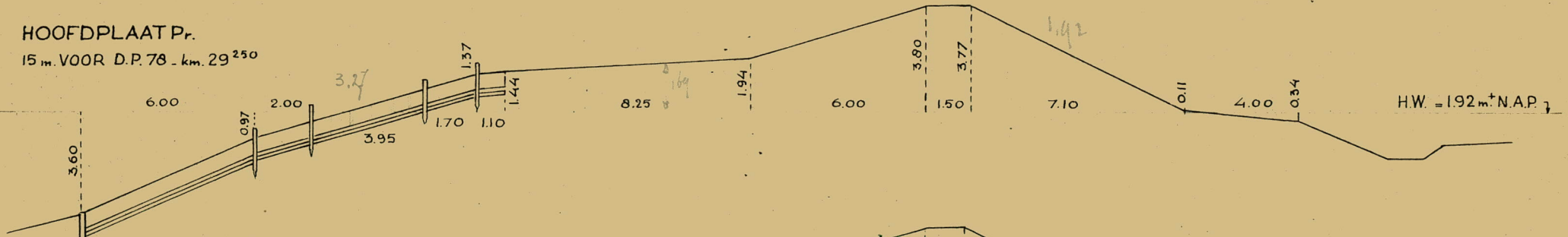

PAULINA Pr.

510.70 m. UIT BEGIN, km. 32³⁹⁰

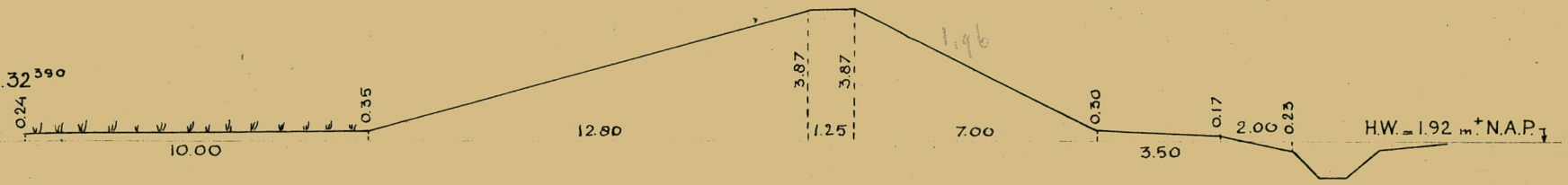

BULAGE 8

DWARSPROFIELEN ZEEUWSCH VLAANDEREN (4)

SCHAAL 1:200

ELISABETH Pr.

1460 m. UIT BEGIN, - km. 35⁷³⁰

H.W. = 1.88 m⁺ N.A.P.

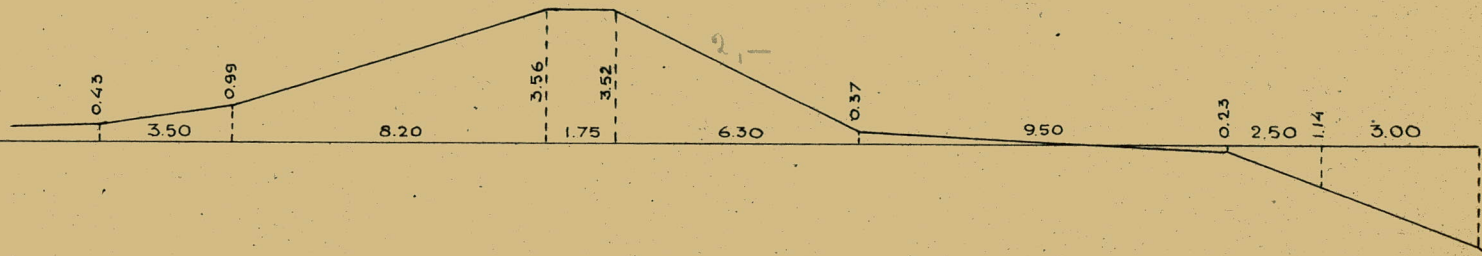

KONINGINNE Pr.

990 m. UIT BEGIN, - km. 37⁴⁸⁰

H.W. = 1.88 m⁺ N.A.P.

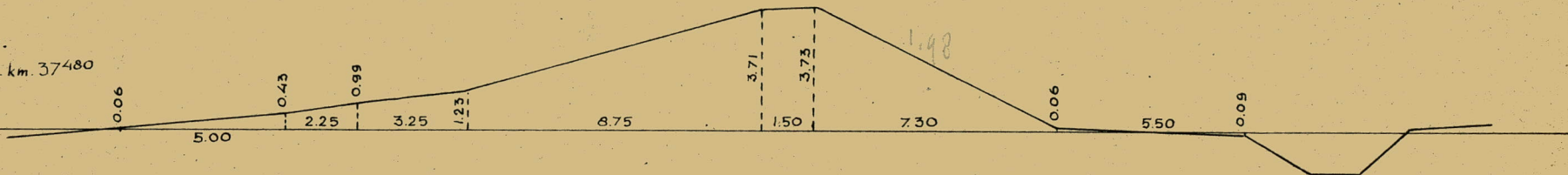

ANGELINA Pr.

1000 m. UIT EIND, - km. 40⁸⁴⁰

H.W. = 1.95 m⁺ N.A.P.

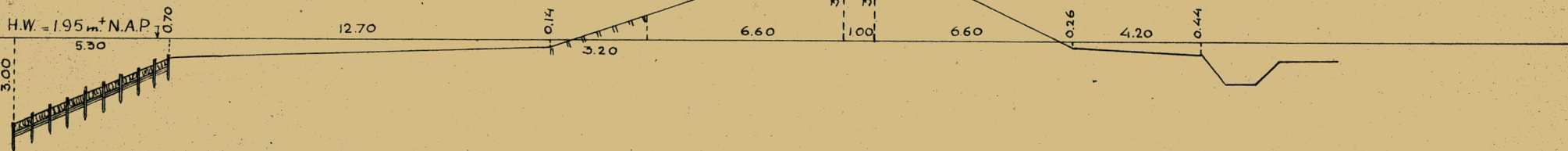

KLEINE ISABELLA Pr.

180 m. UIT BEGIN, - km. 43²⁰⁰

H.W. = 2.00 m⁺ N.A.P.

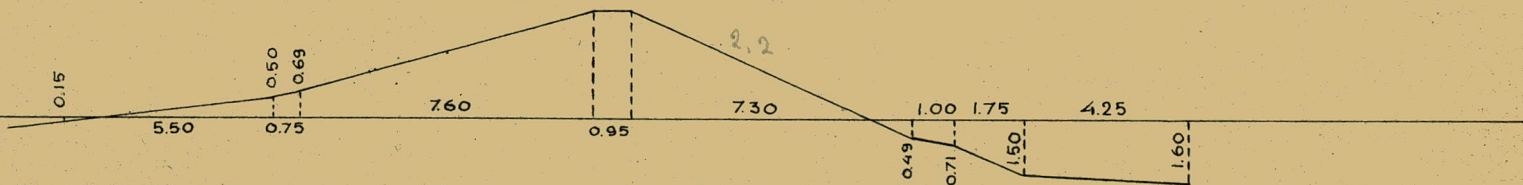

BULAGE 9

DWARSPROFIELEN ZEEUWSCH VLAANDEREN (5)

SCHAAL 1:200

DJUCKMEESTERP.

D.P. 19 - km. 45⁸⁰⁰

H.W. = 2.00 m + N.A.P.

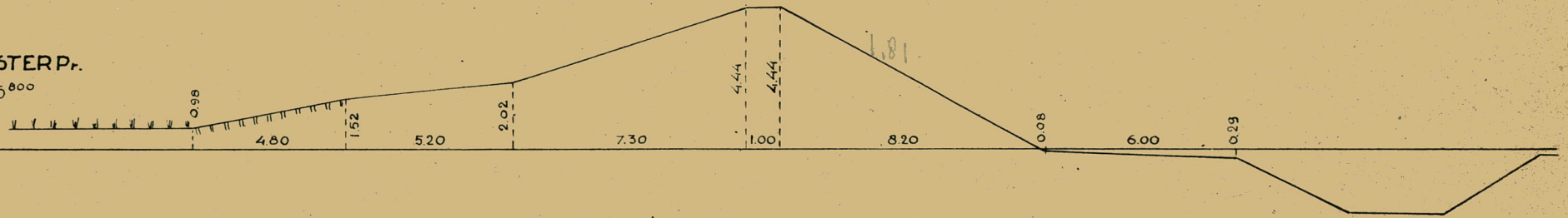

KANAALP.

60 m. UIT_BEGIN - km. 51⁸⁷⁰

H.W. = 1.90 m + N.A.P.

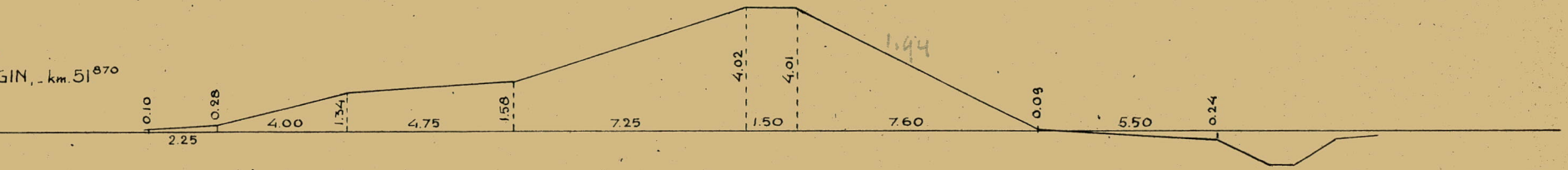

KOUDEP.

D.P. 4 - km. 56⁴¹⁰

H.W. = 1.90 m + N.A.P.

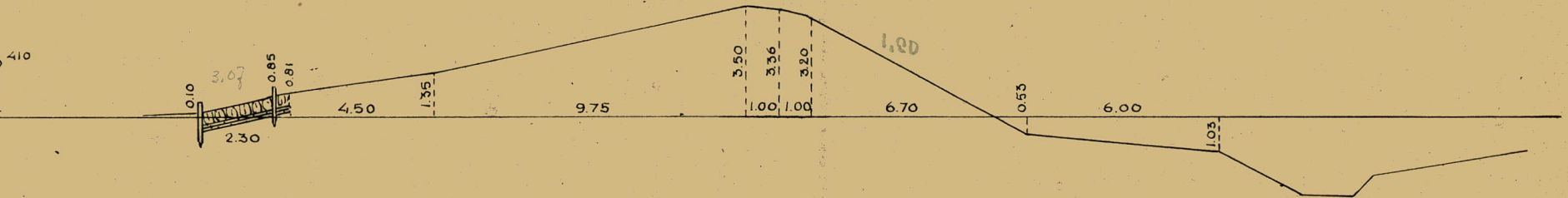

KOUDEP.

D.P. 28 - km. 58⁸¹⁵

H.W. = 1.90 m + N.A.P.

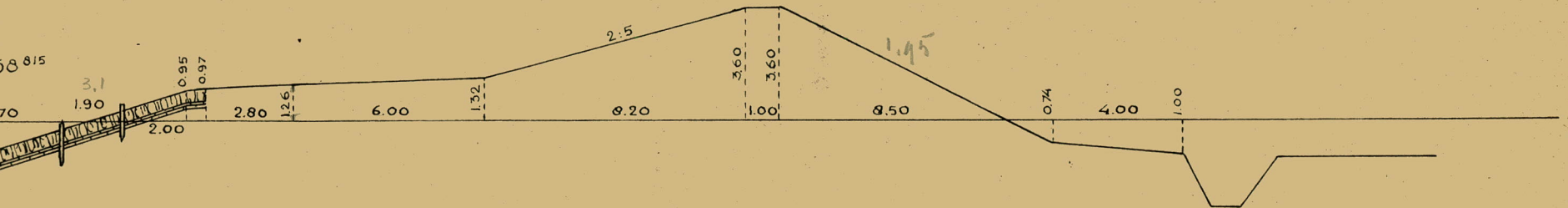

BULAGE 10

DWARSPROFIELEN ZEEUWSCH VLAANDEREN (6)

SCHAAL 1:200

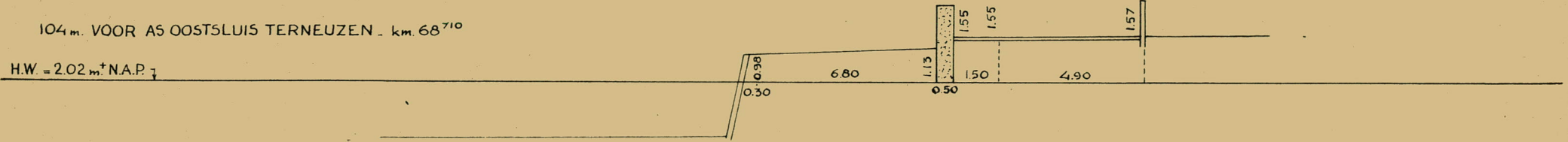
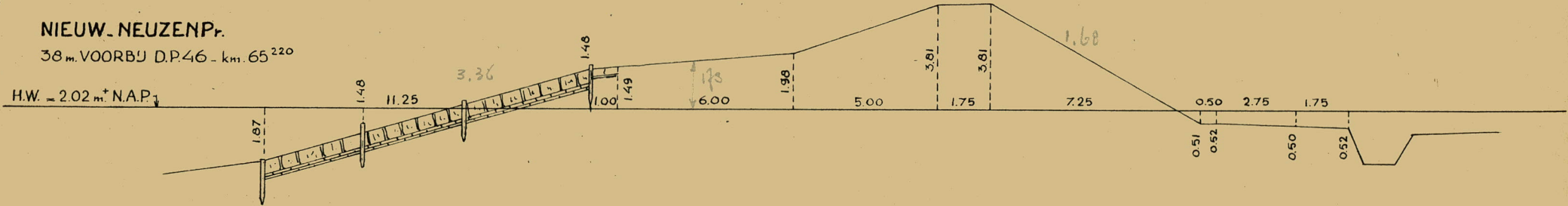
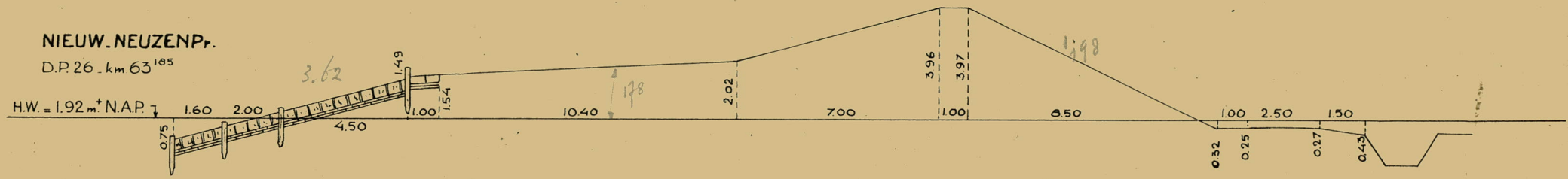
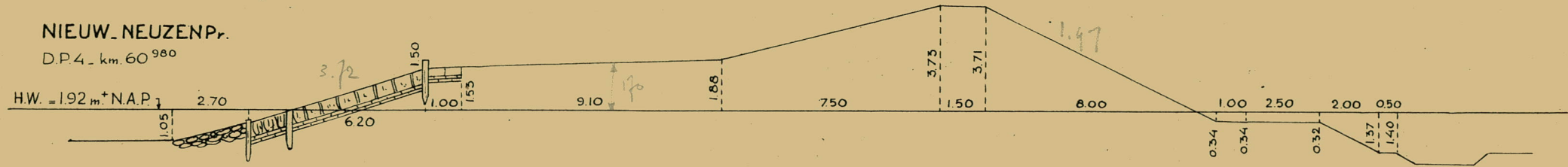

BYLAGE 11

DWARSPROFIELEN ZEEUWSCH VLAANDEREN (7)

SCHAAL : 1:200

SERLIPPENSPr.

445⁸⁰ m UIT BEGIN, - km. 70⁷⁶⁰

H.W. = 1.92 m⁺ N.A.P.

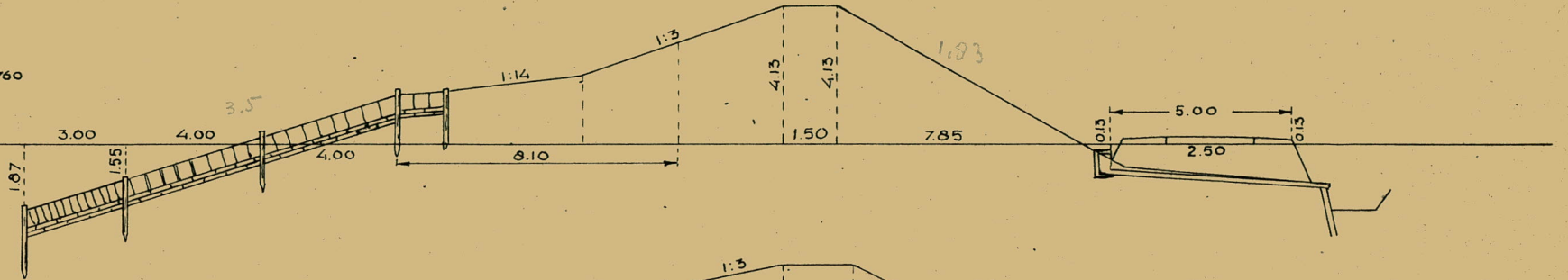

MARGARETHAPr.

D.P. 12 - km. 73³⁹⁰

H.W. = 1.92 m⁺ N.A.P.

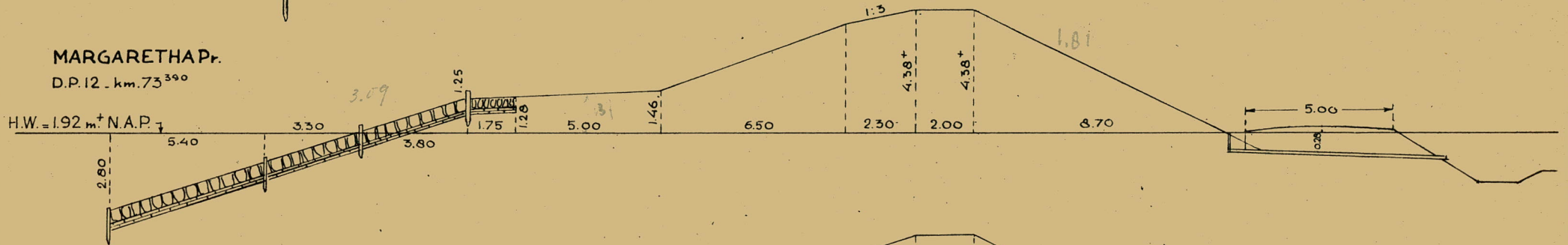

EENDRACHTPr.

D.P. 4 - km. 76¹⁹⁵

H.W. = 2.05 m⁺ N.A.P.

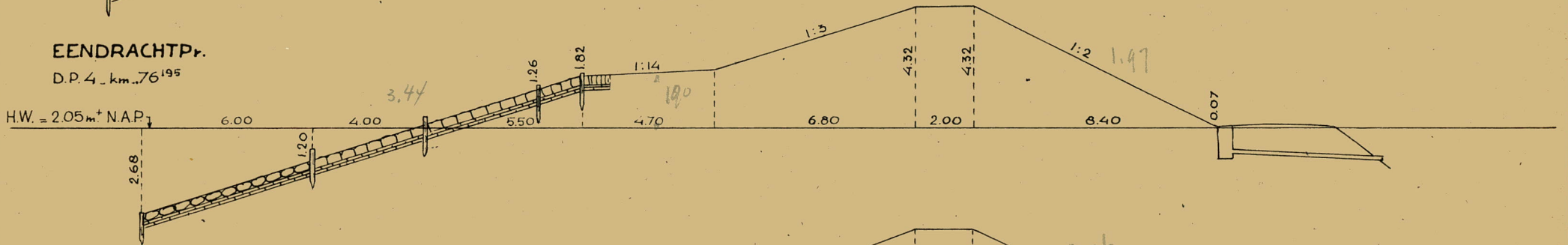

EENDRACHTPr.

D.P. 26 - km. 78³⁹⁵

H.W. = 2.05 m⁺ N.A.P.

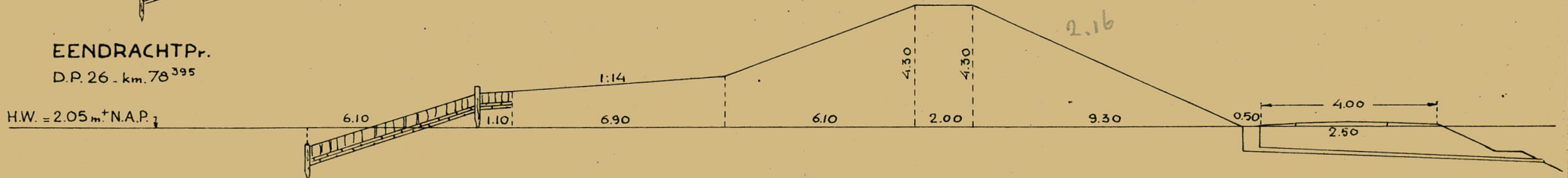

BULAGE 1.2

DWARSPROFIELEN ZEEUWSCH VLAANDEREN (8)

SCHAAL 1:200

WILLEM III Pr.

435 m. UIT BEGIN. km. 81460

H.W. = 2.04 m⁺ N.A.P. ↓

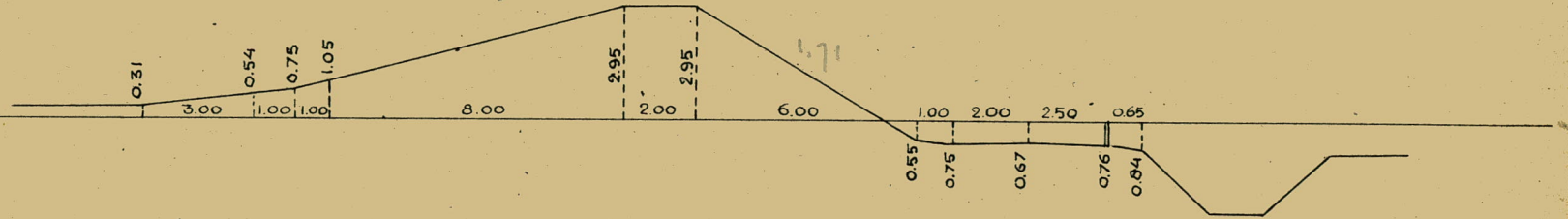

W^P STOPPELDIJK

1300 m. UIT BEGIN BETONMUUR km. 84130

H.W. = 2.15 m⁺ N.A.P. ↓

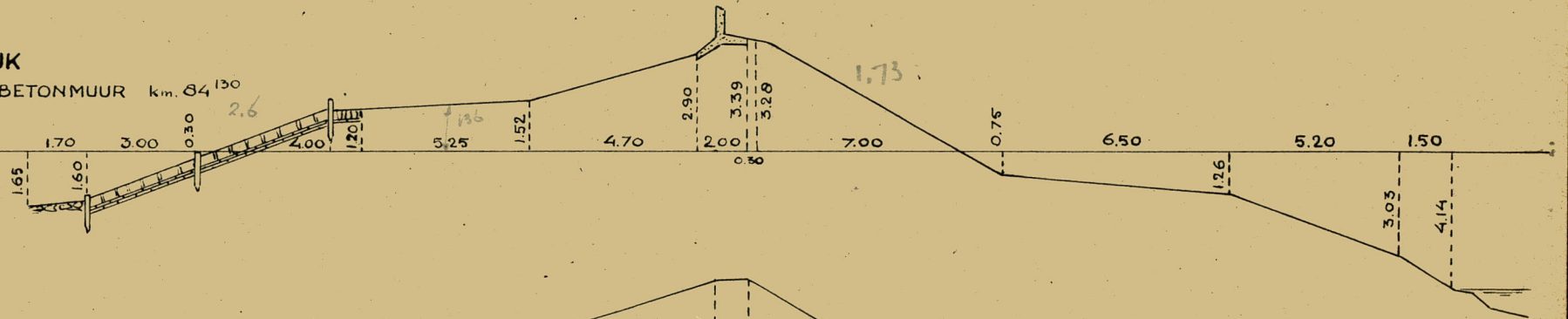

NIJSPr.

D.P. 21. km. 87150

H.W. = 2.04 m⁺ N.A.P. ↓

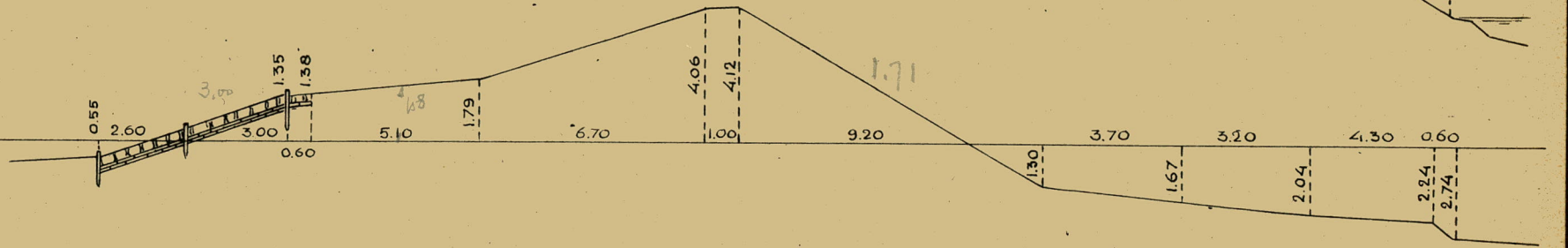

KIEVITTEPr.

D.P. 23. km. 90400

H.W. = 2.08 m⁺ N.A.P. ↓

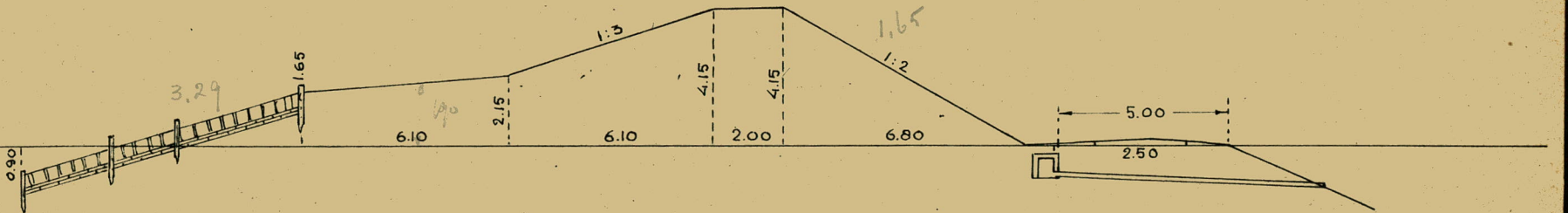

BULAGE 13

DWARSPROFIELEN ZEEUWSCH VLAANDEREN (9)

SCHAAL 1:200

NOORDDUJKPr.

D.P. 51 - km. 93²⁰⁰

HW. = 223 m + N.A.P.

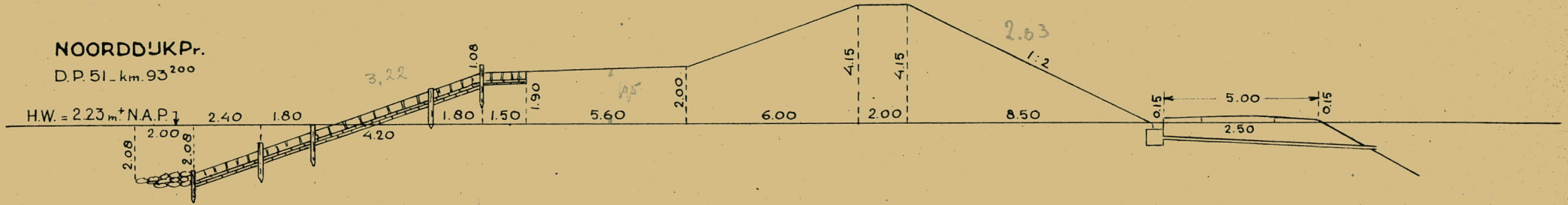

WILHELMUSPr.

D.P. 85 - km. 96⁶⁰⁰

HW. = 223 m + N.A.P.

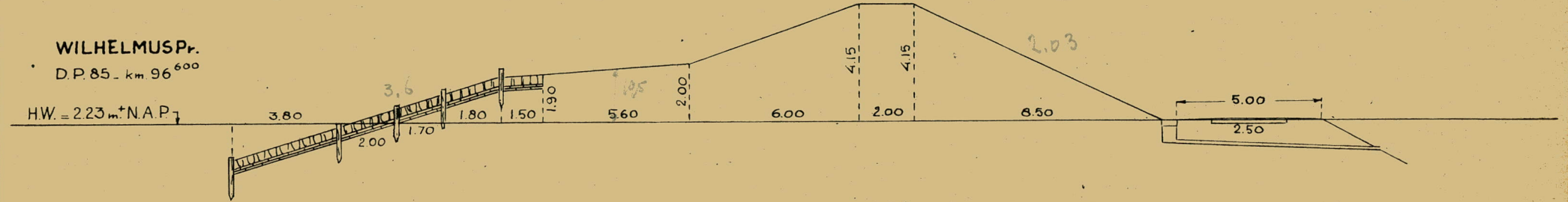

KRUISPr.

D.P. 15 - km. 98⁴²⁰

HW. = 223 m + N.A.P.

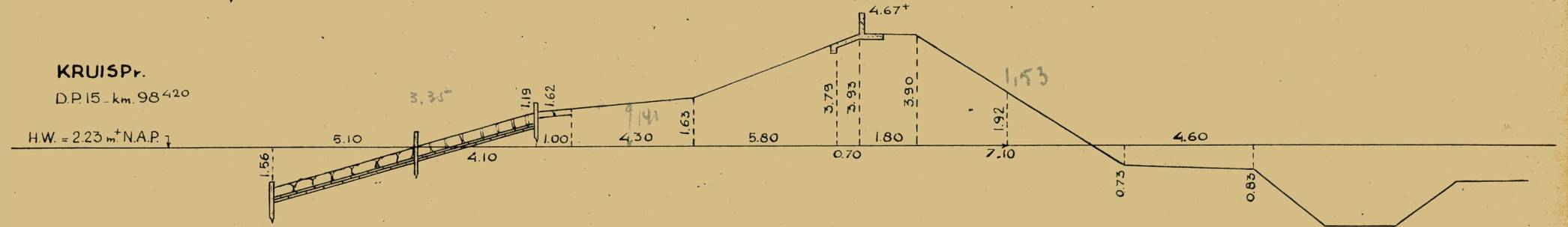

KLEINE MOLENPr.

905 m. UIT BEGIN - km. 101⁵²⁵

HW. = 225 m + N.A.P.

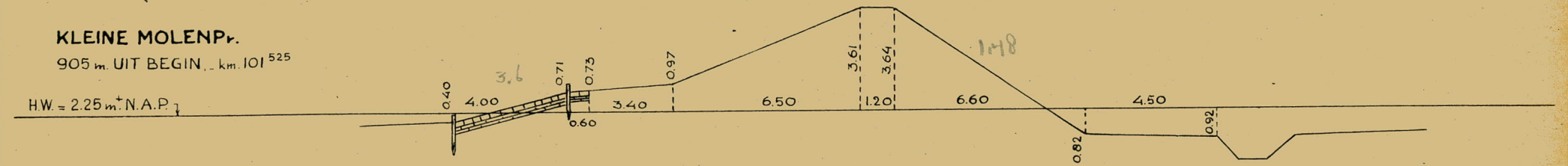

BULAGE 14

DWARSPROFIELEN ZEEUWSCH VLAANDEREN (10.5LOT)

SCHAAL 1:200

KONINGIN EMMAPr.

D.P. 8 - km. 104²⁸⁵

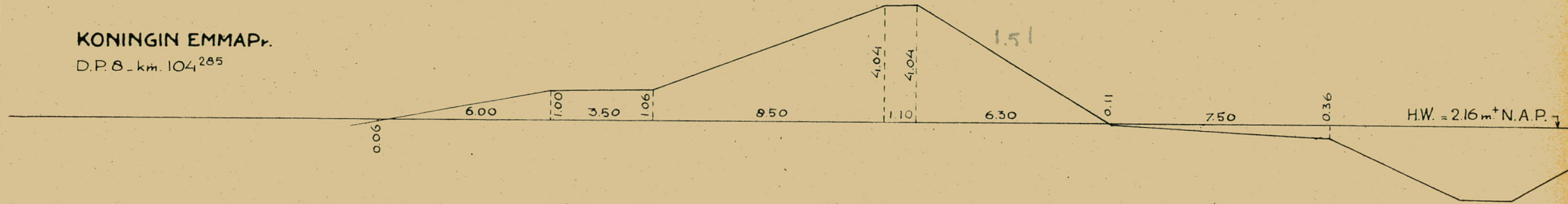

KONINGIN EMMAPr.

D.P. 35 - km. 106⁹⁸⁵

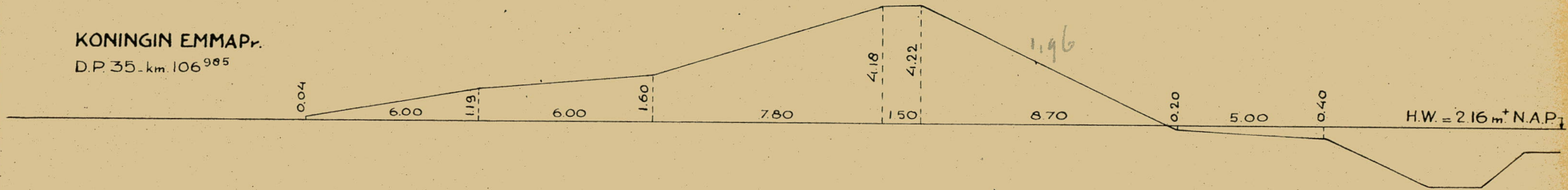

PROSPERPr.

383 m UIT BEGIN, km. 109³⁶⁰

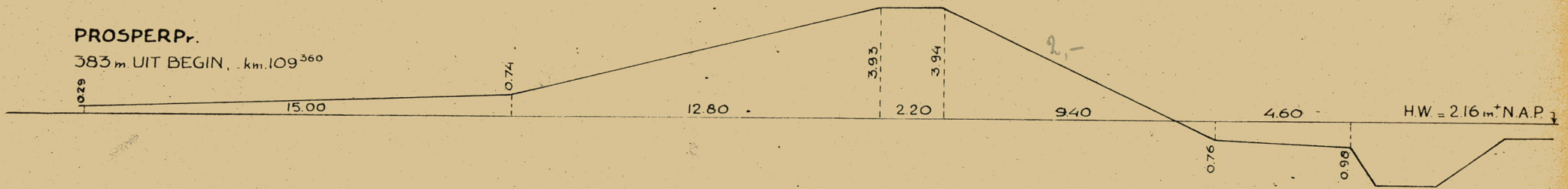

HERTOGIN HEDWIGEPr.

2265 m UIT BEGIN, km. 111⁹⁰⁰

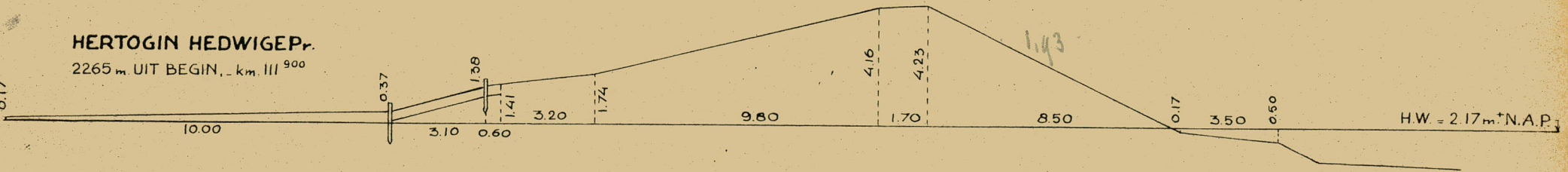

BULAGE

SITUATIE

ZUID BEVELAND

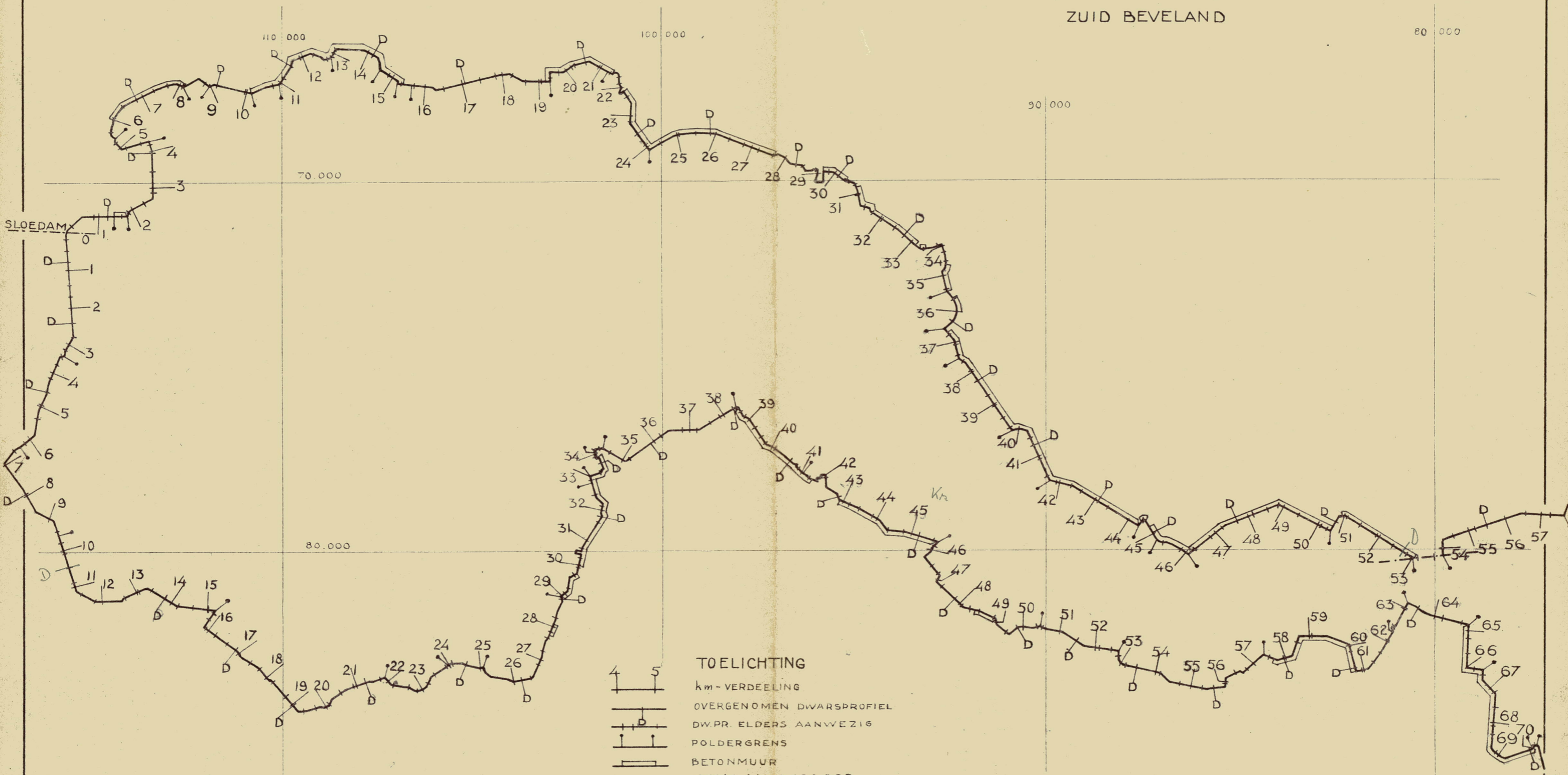

3899 A2

BIJLAGE 16

GEM. DIJKSKRUINHOGGTE PER k.m.

ZUID-BEVELAND LANGS OOSTER-SCHELDE

WATERPASSING 1920-'21-'22
BUGEWERKT TOT 1 JAN 1943

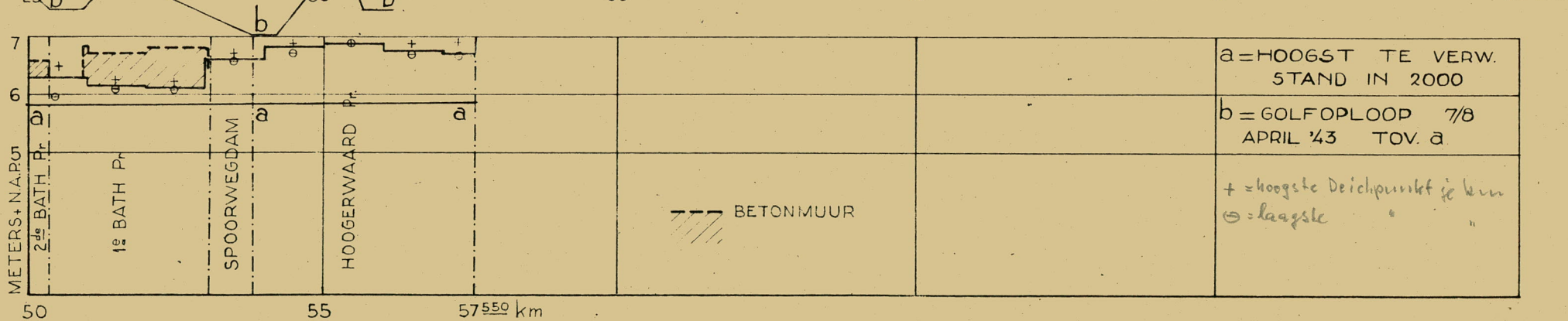
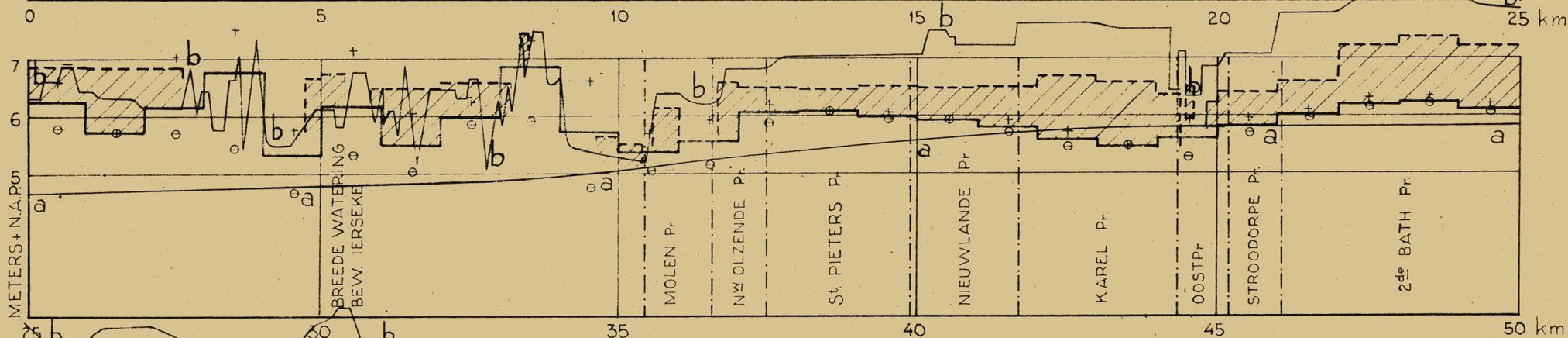
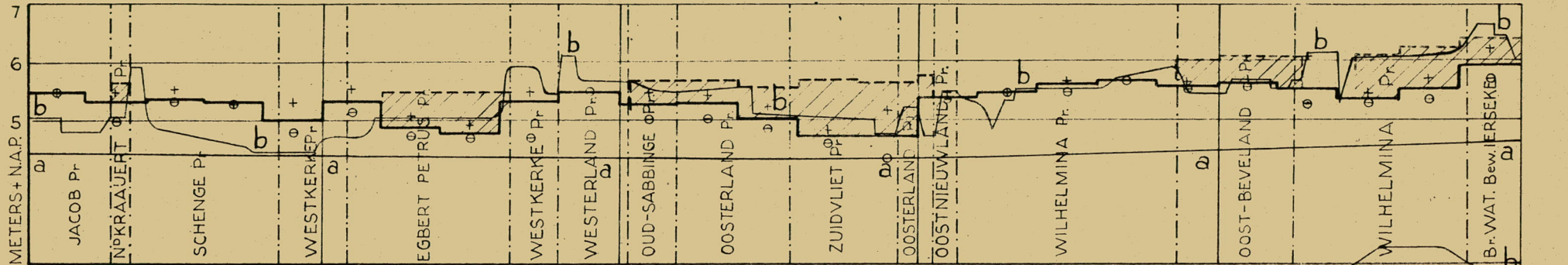

a = HOOGST TE VERW. STAND IN 2000
 b = GOLFOPLOOP 7/8 APRIL '43 TOV. a
 + = hoogste deichpunt in 1943
 ⊙ = laagste

BULAGE

GEM. DIJKSKRUINHOGTE PER k.m.

ZUID-BEVELAND LANGS WESTER-SCHELDE

WATERPASSING 1920-'21-'22
BUGEWERKT TOT 1 JAN 1943

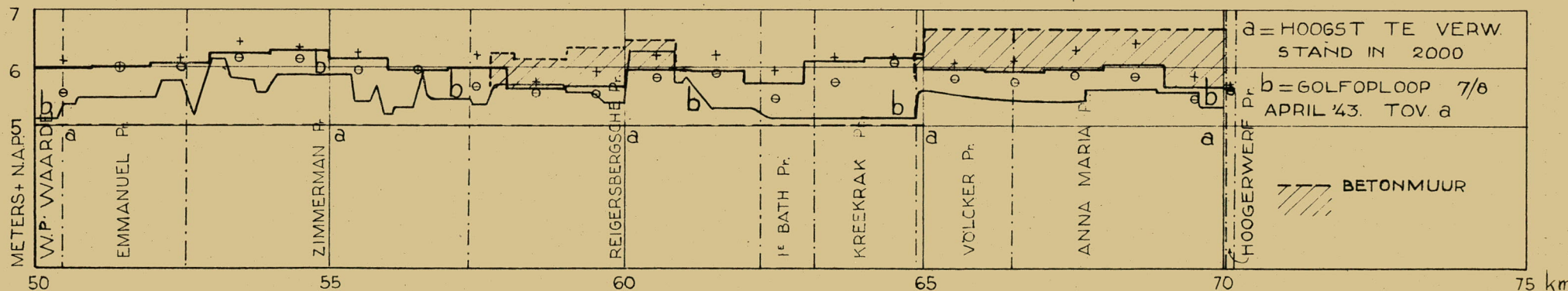
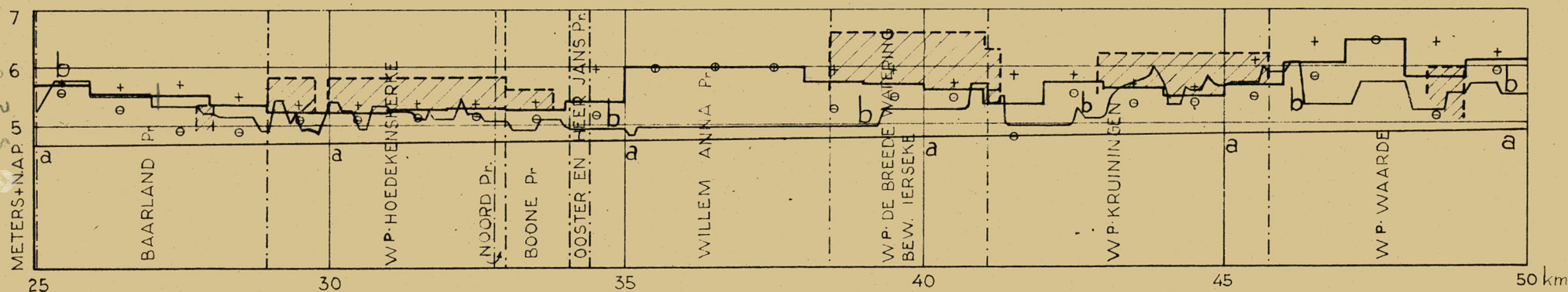
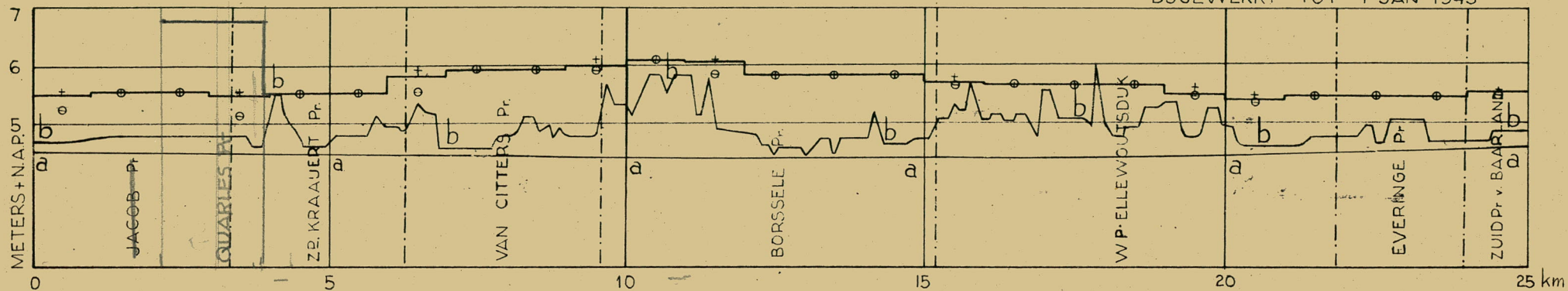

a = HOOGST TE VERW.
STAND IN 2000
b = GOLFOPLOOP 7/8
APRIL '43. TOV. a

BETONMUUR

BULAGE

Handwritten text at the top of the page, possibly a header or title, which is mostly illegible due to fading and bleed-through. Some faint words like "K.M." and "Kilometer" are visible.

A handwritten signature or mark in the center of the page, consisting of a horizontal line with a stylized, possibly illegible, mark below it.

DWARSPROFIELEN ZUID-BEVELAND (1)

SCHAAL 1:200

JACOBPr.
D.P. 47 - km. 1²⁵⁵
H.W. = 1.44 m⁺ N.A.P.₁

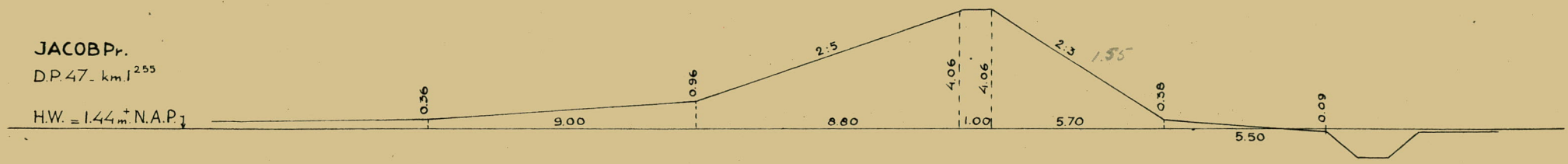

SCHENGEPr.
D.P. 22 - km. 3⁹⁵⁰
H.W. = 1.44 m⁺ N.A.P.₁

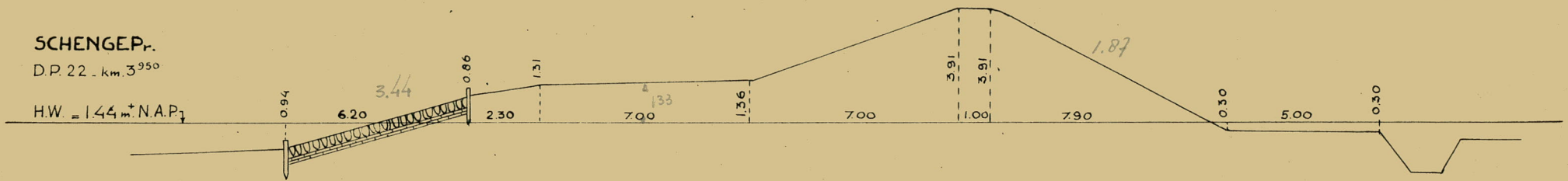

EGBERT.PETRUSPr.
PIK. 15 - km. 6⁸¹⁰
H.W. = 1.44 m⁺ N.A.P.₁

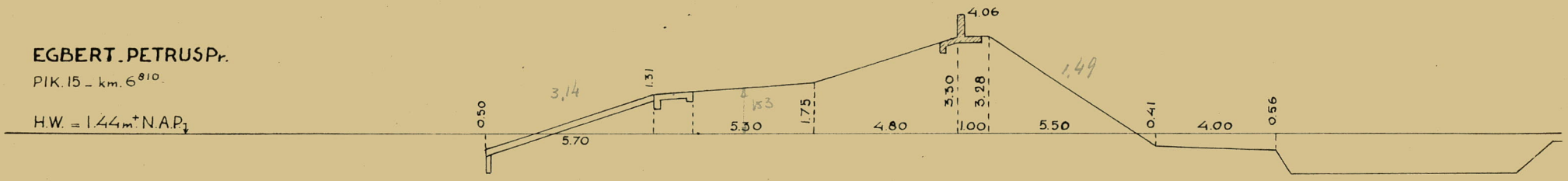

WESTERLANDPr.
PIK. C - km. 9¹⁷⁵
H.W. = 1.44 m⁺ N.A.P.₁

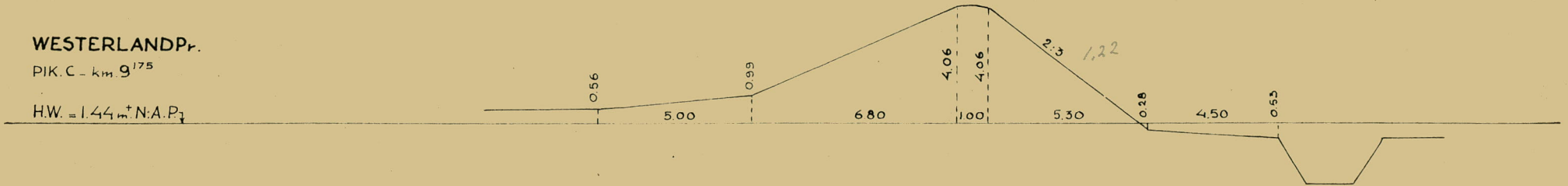

BILAGE 19

DWARSPROFIELEN ZUID-BEVELAND (2)

SCHAAL 1:200

OOSTERLANDP.r.

D.P. 14 - km. 11⁵⁴⁰

H.W. = 1.44 m⁺ N.A.P.

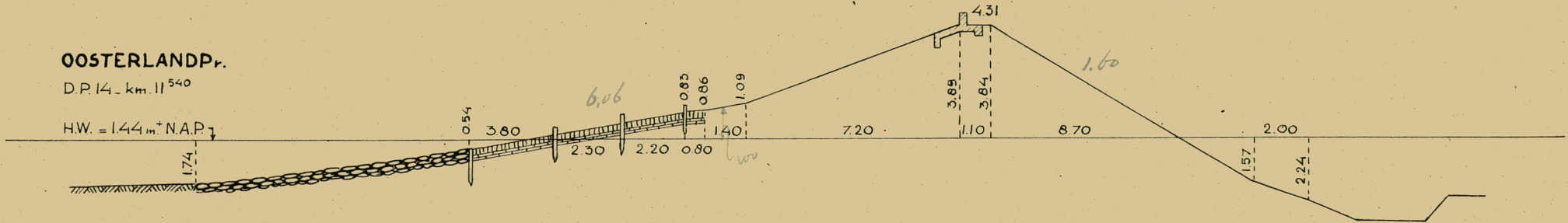

ZUIDVLIETP.r.

18 m. VOORBY PIK. N - km. 14¹⁷⁰

H.W. = 1.44 m⁺ N.A.P.

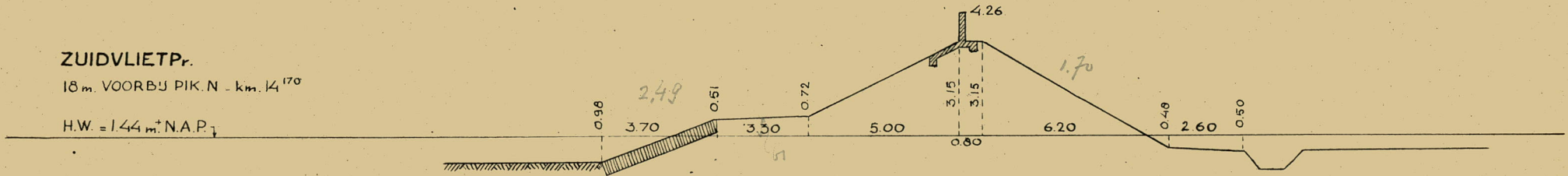

WILHELMINAP.r.

D.P. 14 - km. 17⁰⁴⁵

H.W. = 1.46 m⁺ N.A.P.

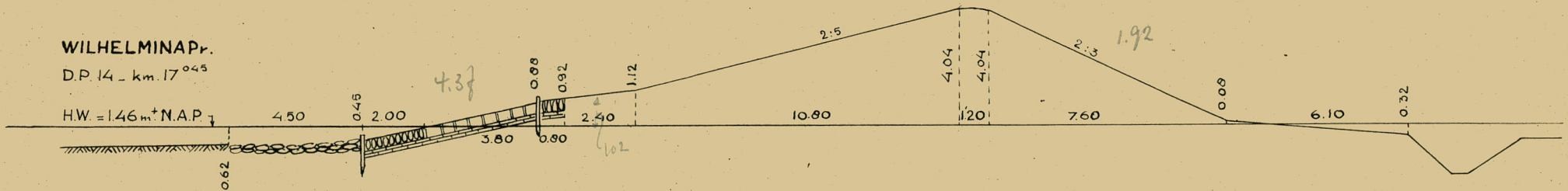

BULAGE

20

DWARSPROFIELEN ZUID-BEVELAND (3)

SCHAAL 1:200

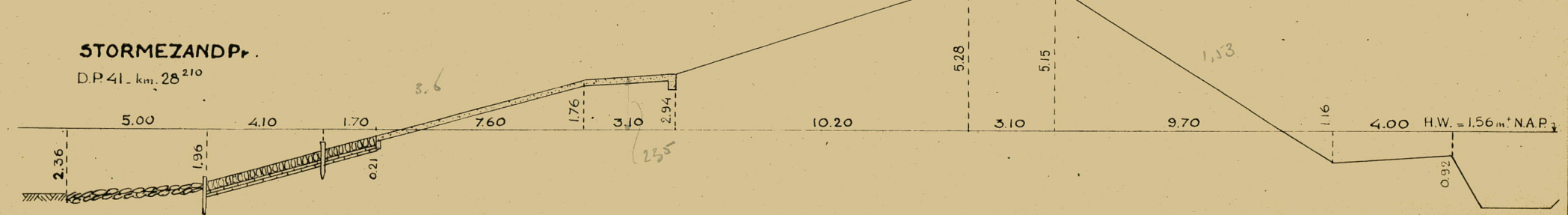
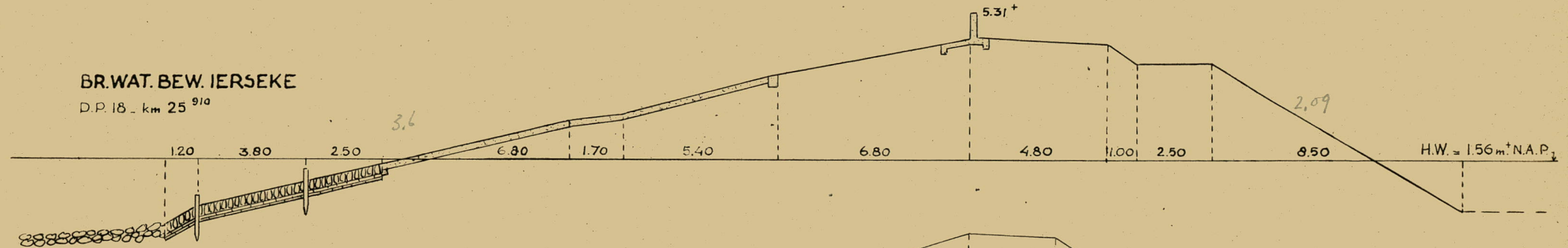
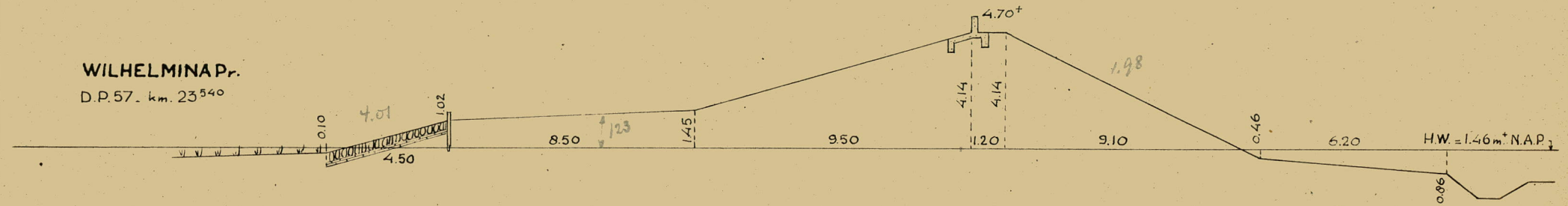
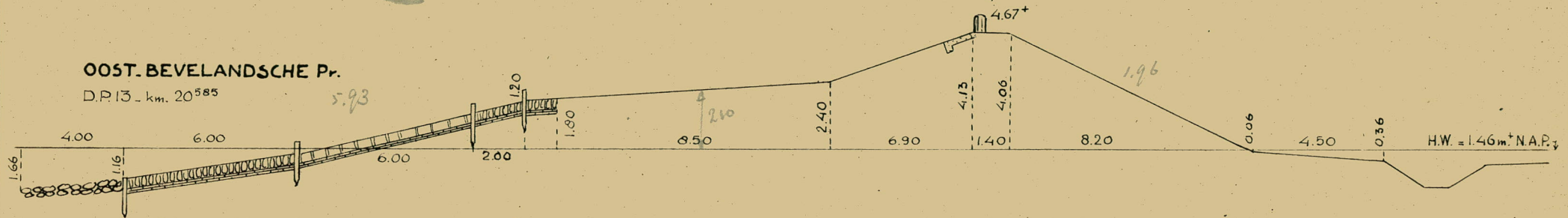

DWARSPROFIELEN ZUID-BEVELAND (4)

SCHAAL 1:200

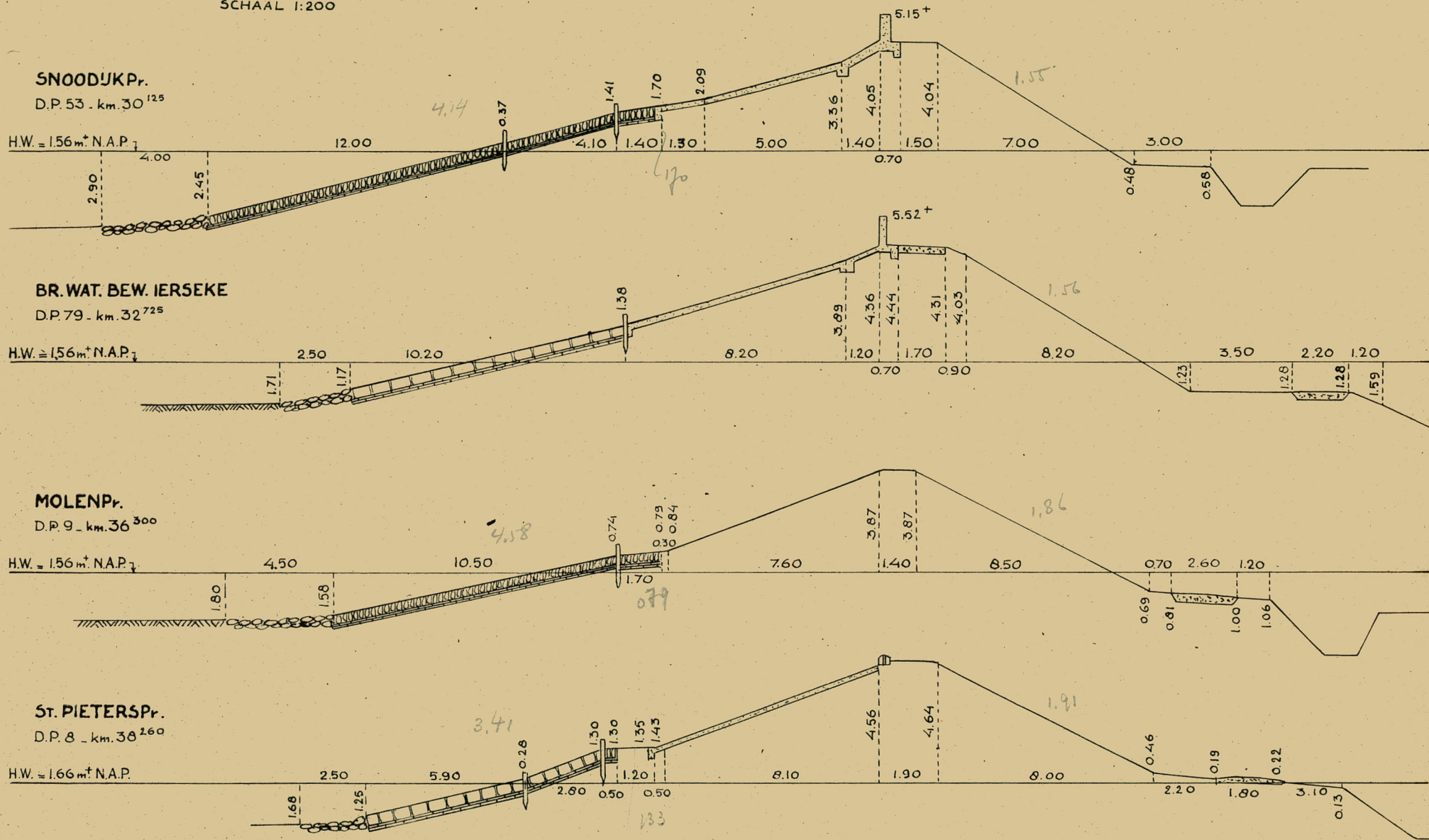

BILAGE 22

DWARSPROFIELEN ZUID-BEVELAND (5)

SCHAAL 1:200

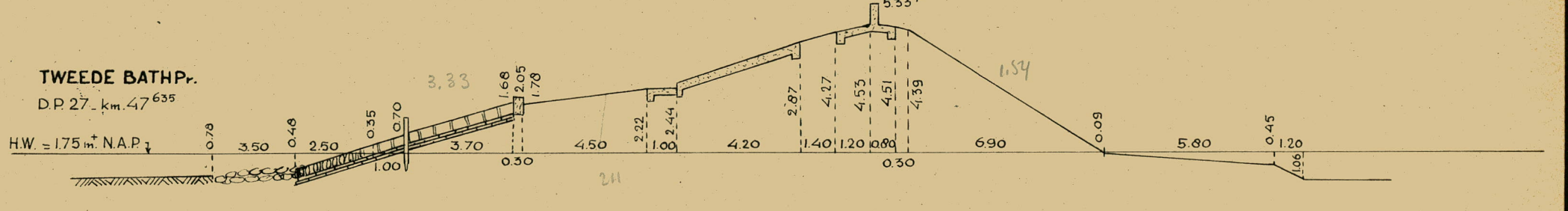
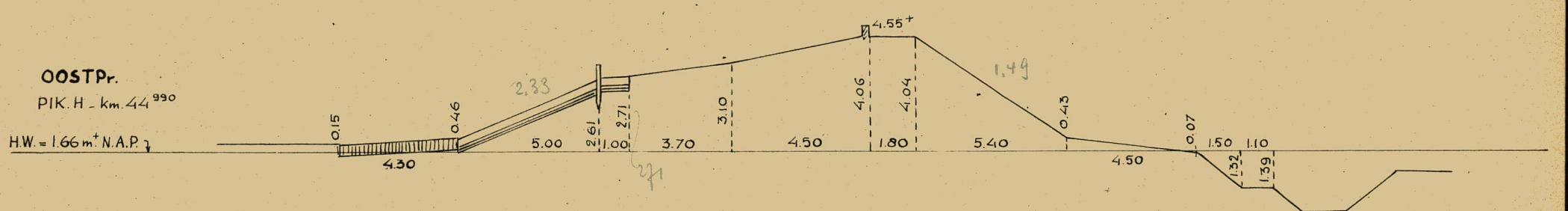
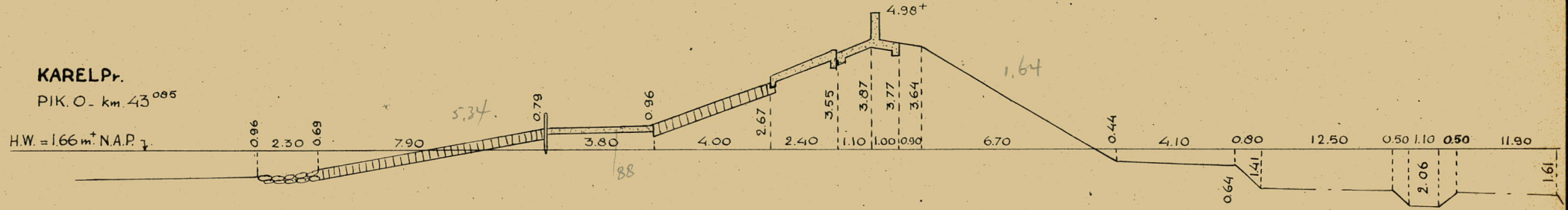
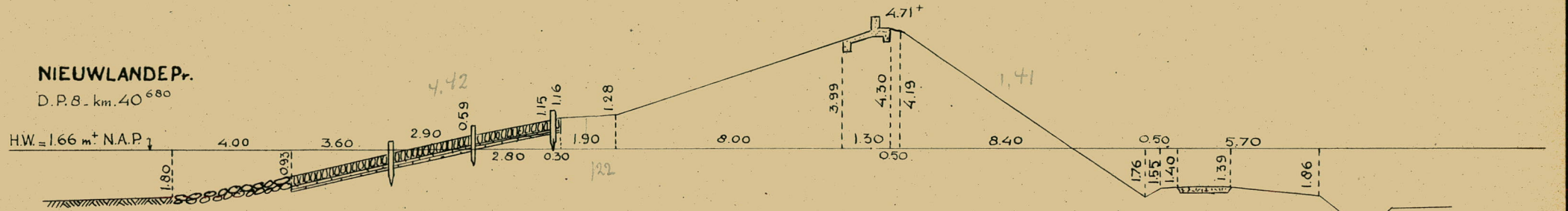

BILAGE 23

DWARSPROFIELEN ZUID-BEVELAND (6)

SCHAAL 1:200

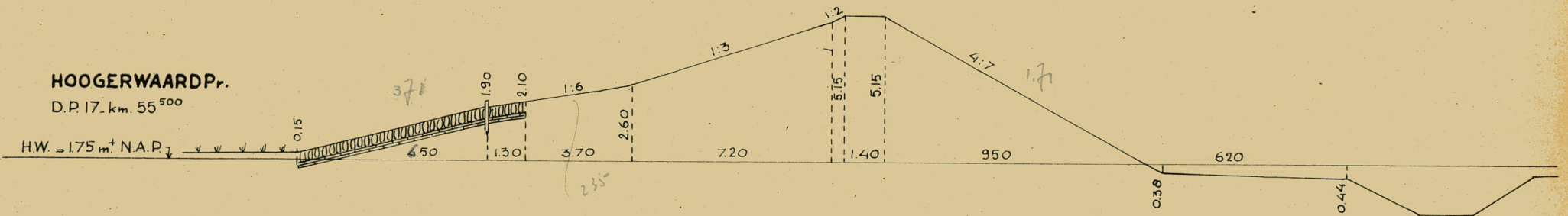
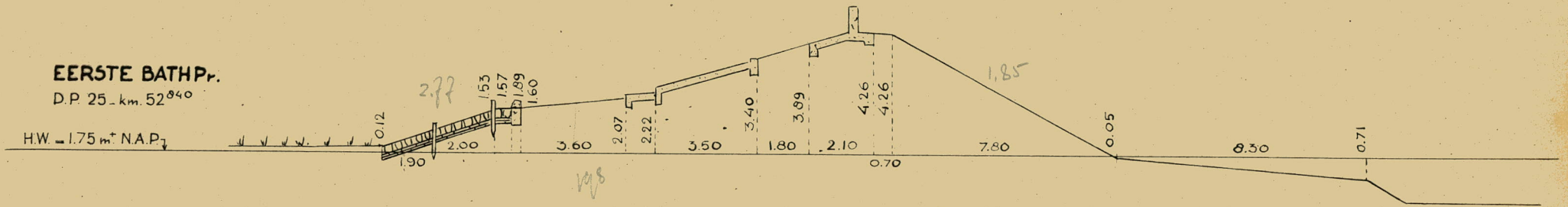
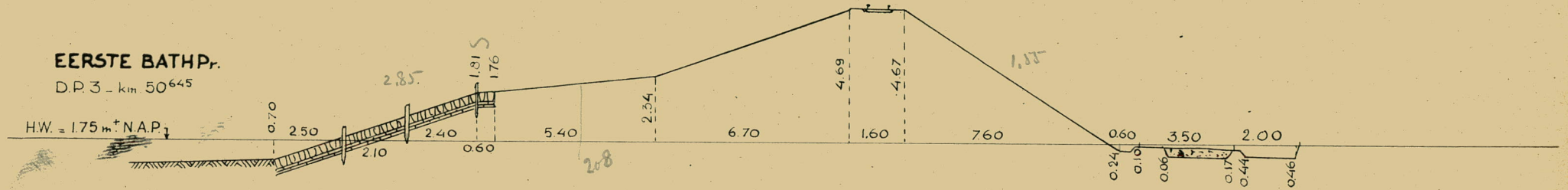

BULAGE 24

DWARSPROFIELEN ZUID-BEVELAND (7)

SCHAAL 1:200

JACOBPr.

D.P. 26 - km 0⁸¹⁵

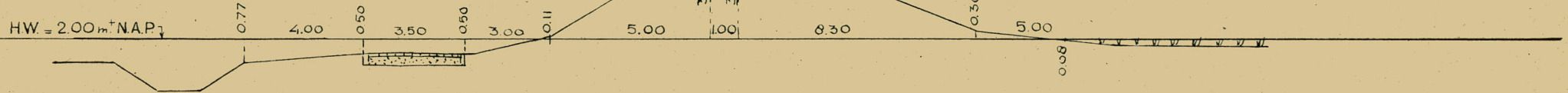

JACOBPr.

D.P. 10 - km 2⁴¹⁰

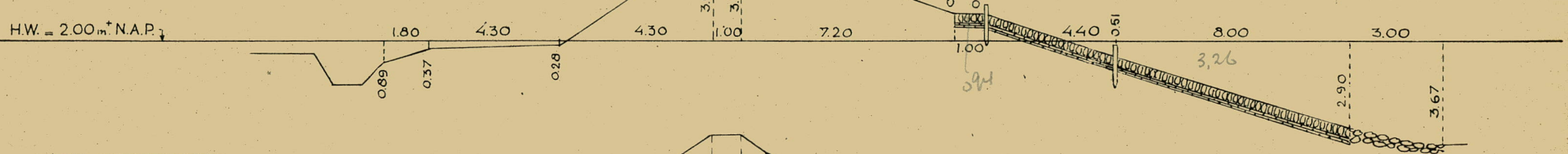

ZUID-KRAAUJERTPr.

D.P. 32 - km 4⁵⁶⁰

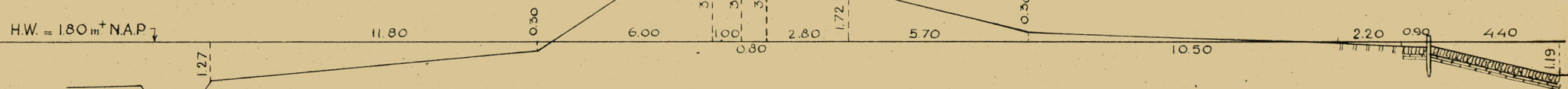

VAN CITTERSPr.

D.P. 16 - km 7⁹⁹⁰

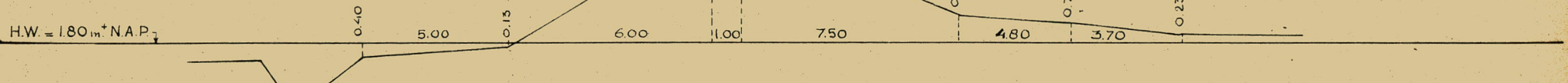

BORSSELEPr.

D.P. 47 - km 10⁵¹⁰

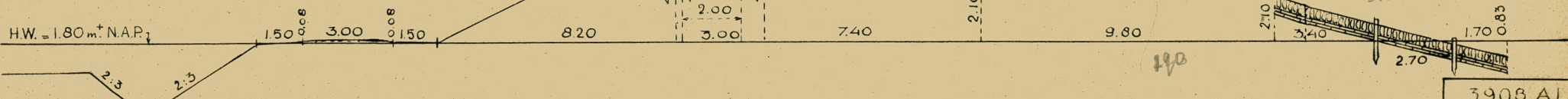

BULAGE 25

DWARSPROFIELEN ZUID-BEVELAND (8)

SCHAAL 1:200

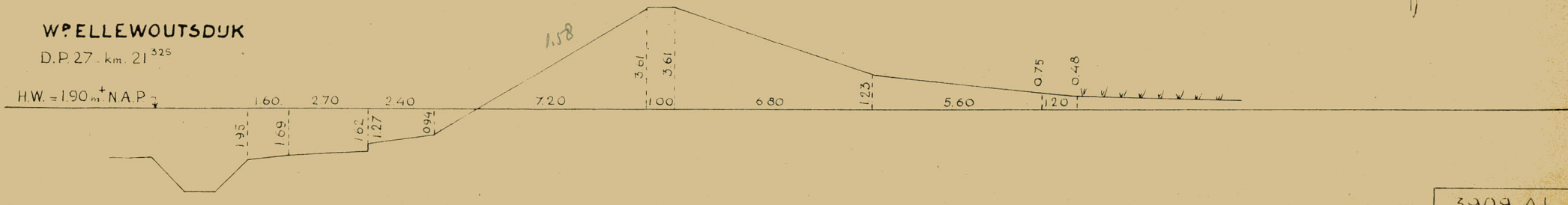
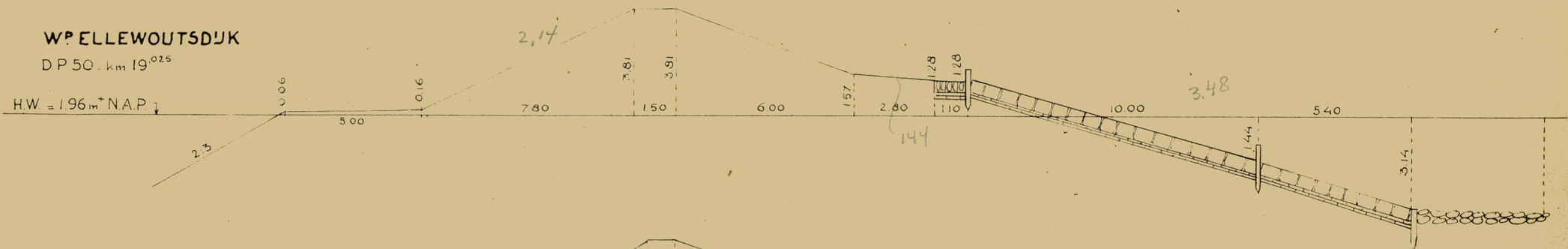
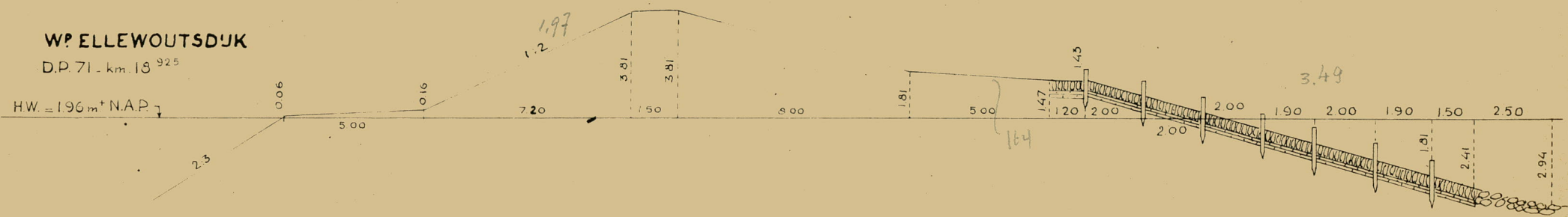
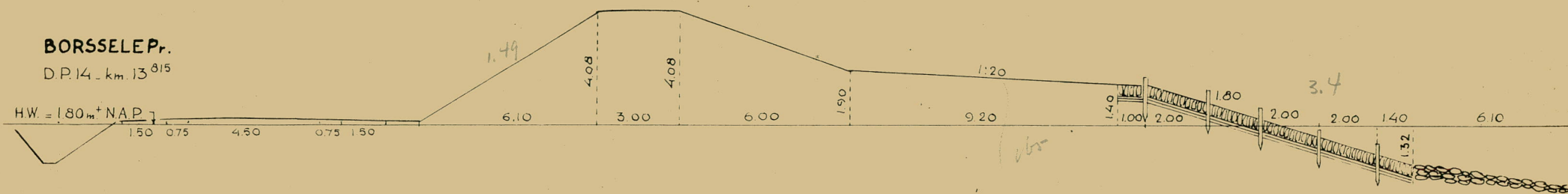

BULAGE 26

DWARSPROFIELEN ZUID-BEVELAND (9)

SCHAAL 1:200

ZUIDPR. VAN BAARLAND

D.P. 46 - km. 24.⁴⁸⁰

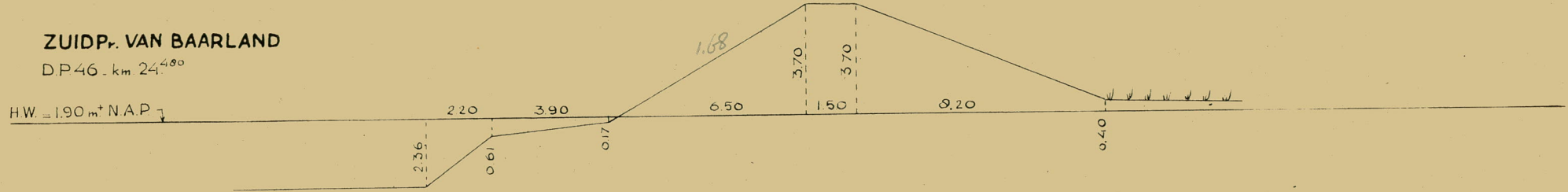

BAARLANDPR.

D.P. 29 - km. 26.¹⁹⁰

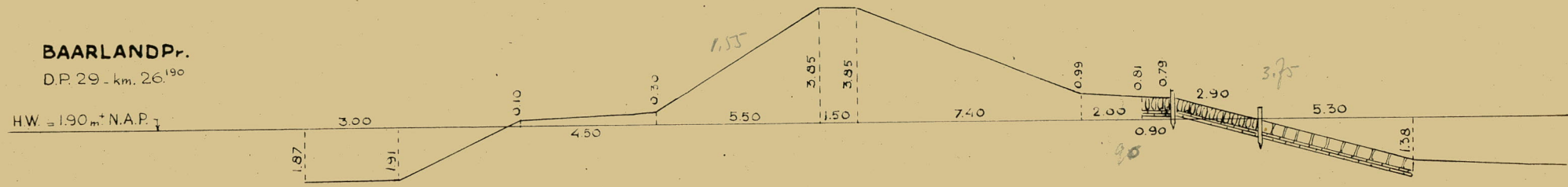

BAARLANDPR.

D.P. 2 - km. 28.⁹⁸⁰

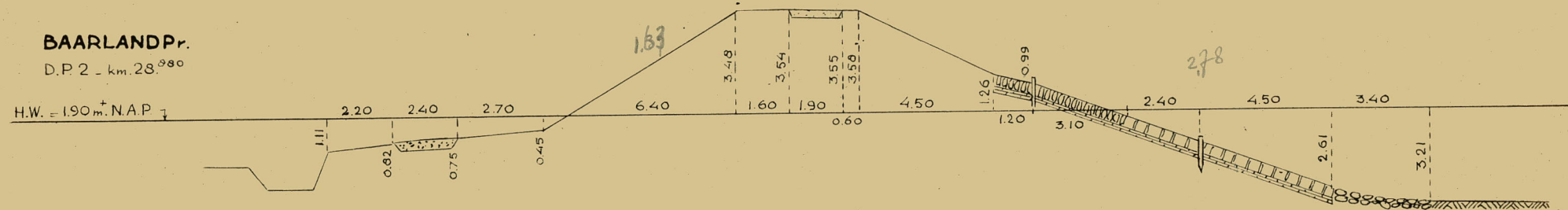

WP HOEDEKENSKERKE

D.P. 12 - km. 31.⁰⁰⁰

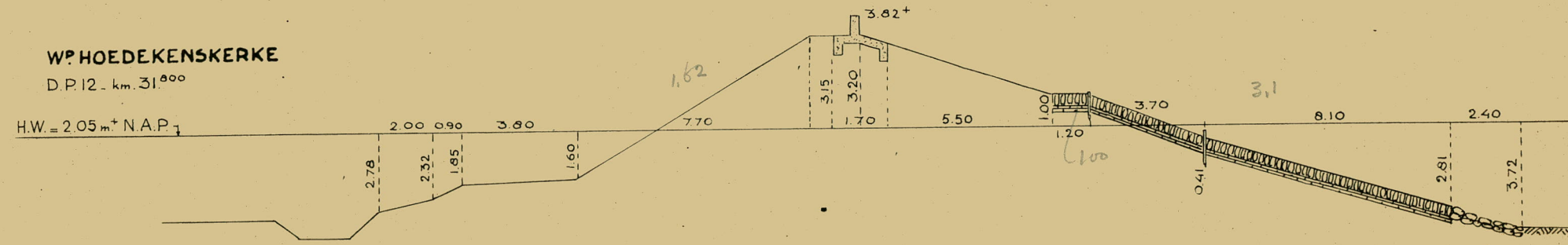

DWARSPROFIELEN ZUID-BEVELAND (10)

SCHAAL 1:200

BOONE Pr.

D.P. 5 km. 33⁵⁷⁰

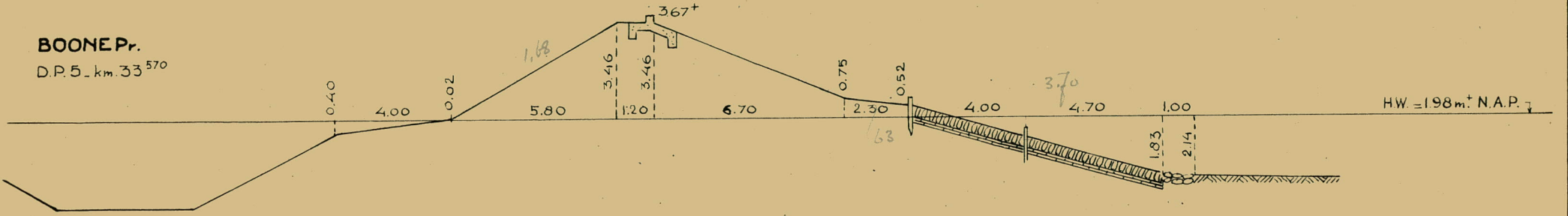

WILLEM ANNA Pr.

D.P. 25 km. 35⁹¹⁰

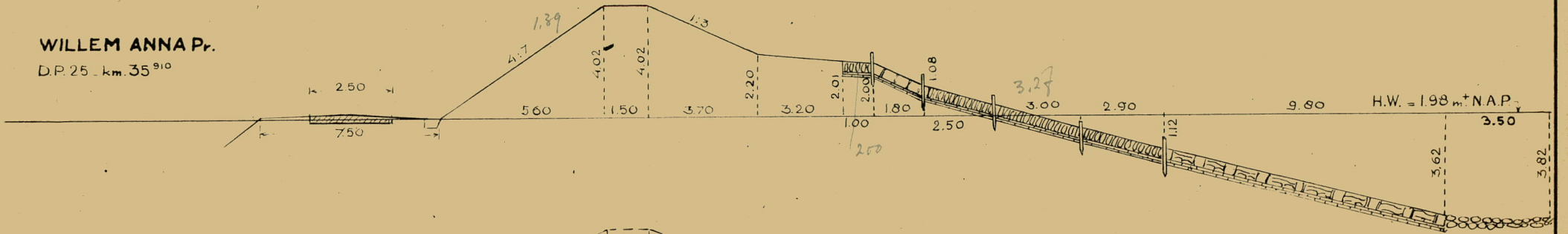

WILLEM ANNA Pr.

D.P. I km. 38³¹⁰

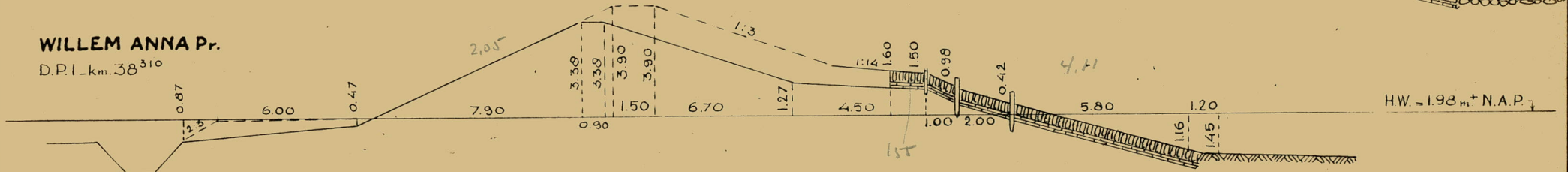

BR. WAT. BEW. IERSEKE

D.P. II km. 40⁵⁵⁰

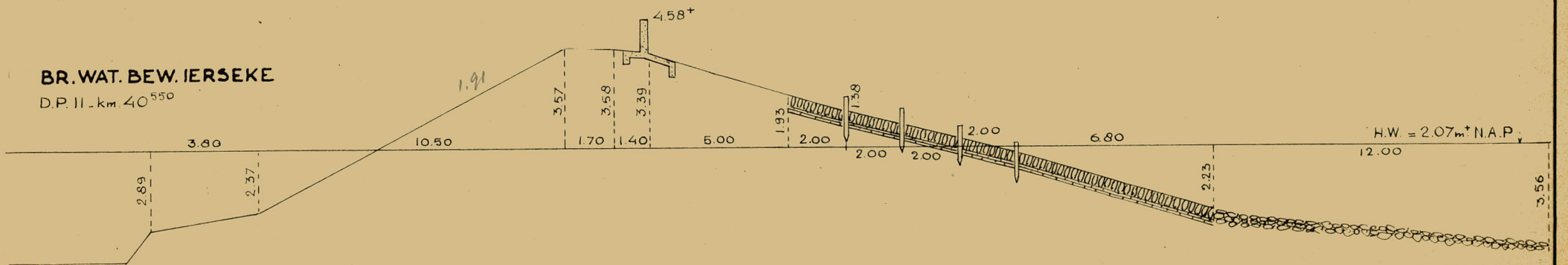

BILAGE 28

3911 A1

DWARSPROFIELEN ZUID-BEVELAND (11)

SCHAAL 1:200

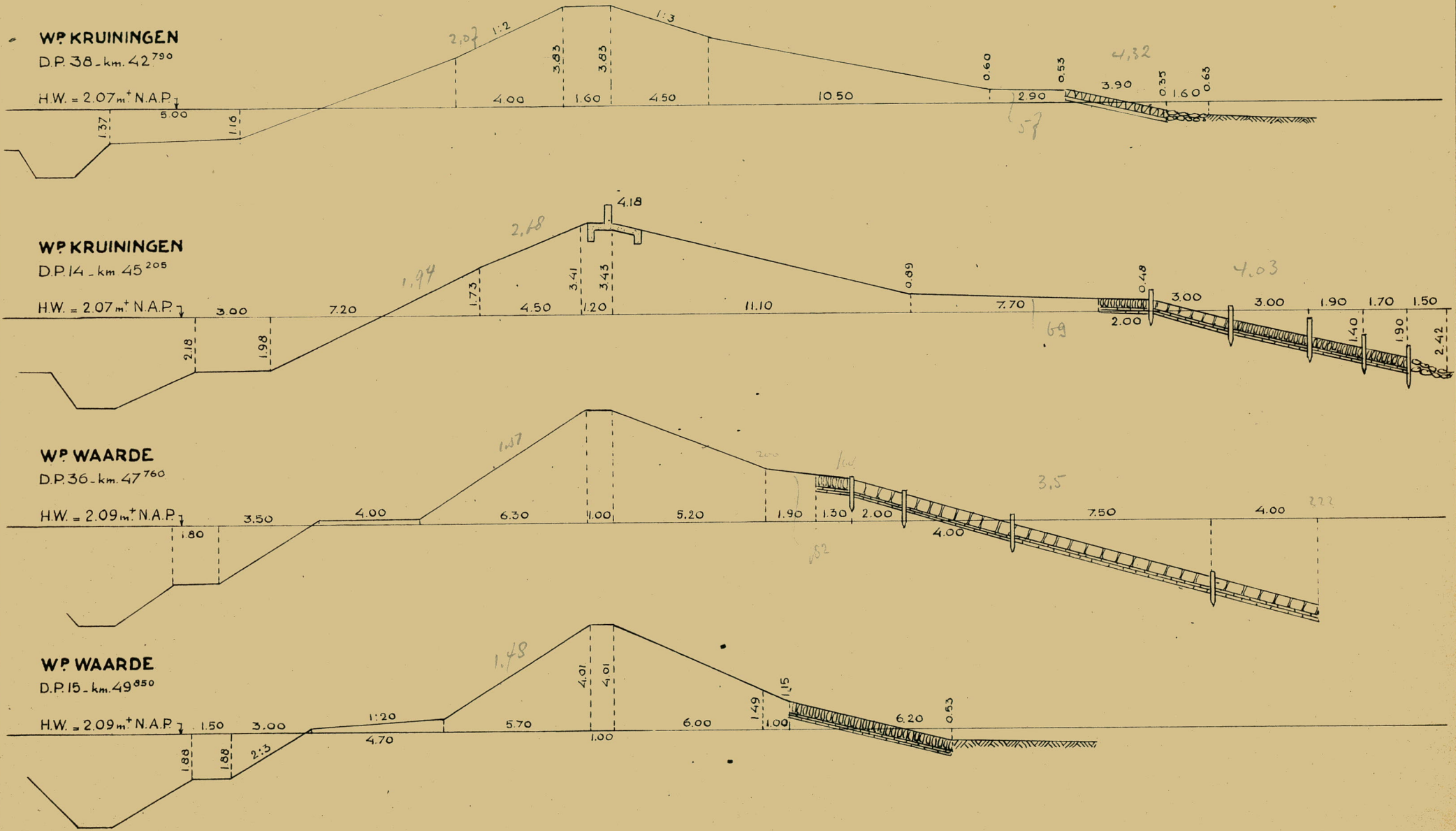

BULAGE 29

DWARSPROFIELEN ZUID-BEVELAND (12)

SCHAAL 1:200

EMMANUEL Pr.

D.P. 11. km 51⁵⁰⁰

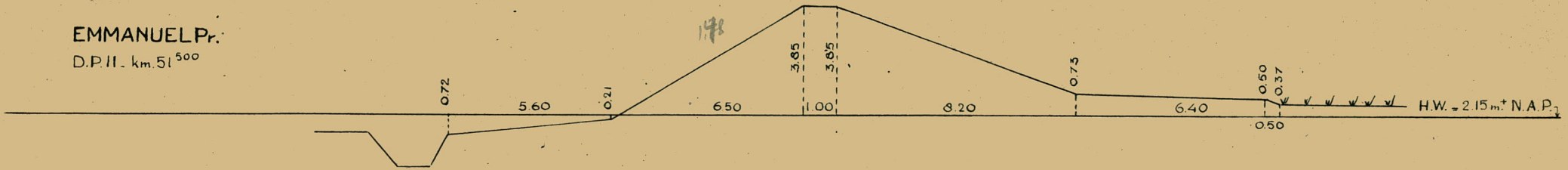

ZIMMERMAN Pr.

D.P. 39. km 53⁴⁸⁰

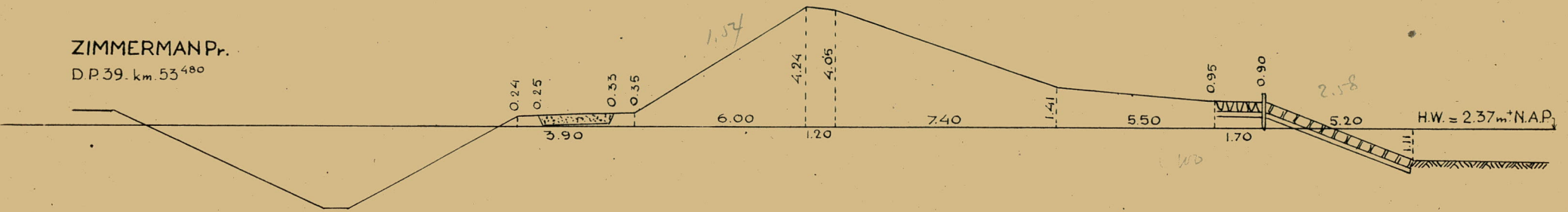

ZIMMERMAN Pr.

D.P. 18. km 55⁵⁷⁵

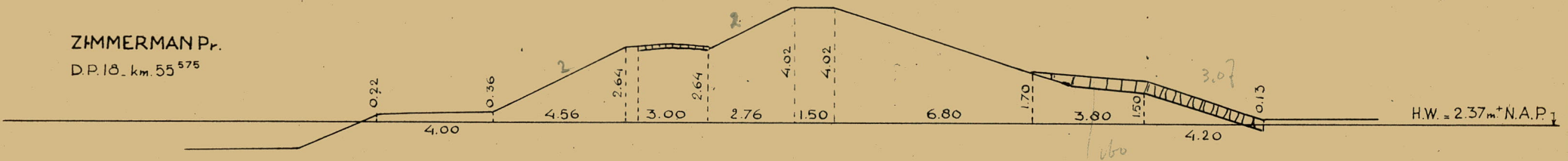

REIGERSBERGSCH Pr.

D.P. 43. km 57⁹⁷⁰

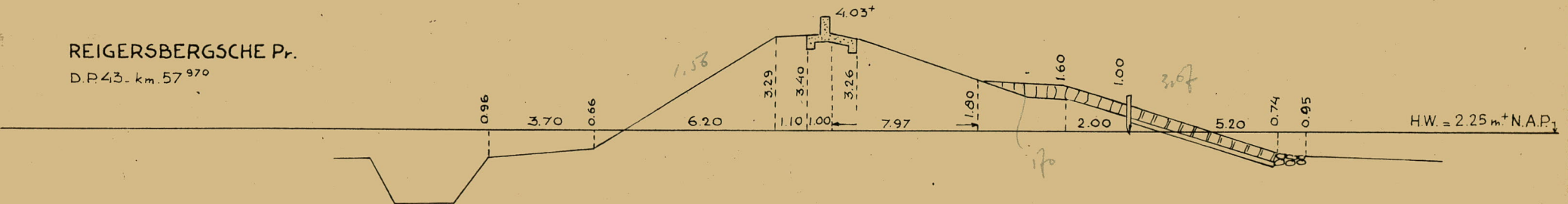

BULAGE 311

DWARSPROFIELEN ZUID-BEVELAND (13 SLOT)

SCHAAL 1:200

REIGERBERGSCHE Pr.

D.P. 16 - km. 60⁶⁷⁰

H.W. = 2.25 m⁺ N.A.P.

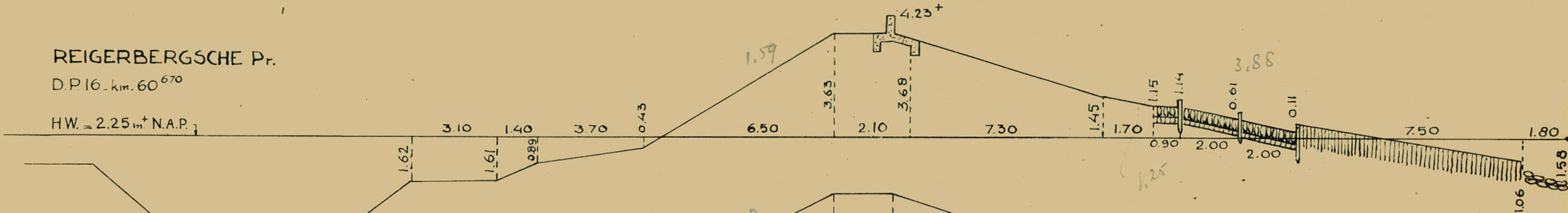

KREEKRAK Pr.

PIK. C. - km. 63⁴⁸⁰

H.W. = 2.25 m⁺ N.A.P.

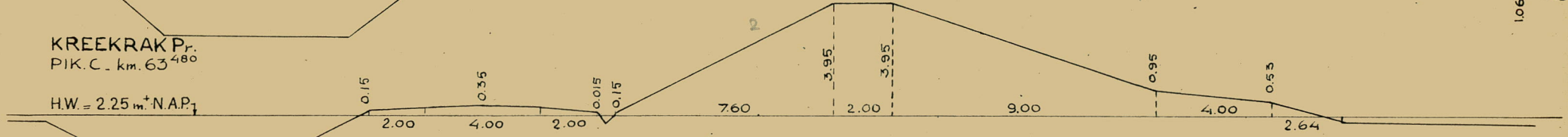

VÖLCKER Pr.

D.P. 8 - km. 65⁶⁴⁰

H.W. = 2.25 m⁺ N.A.P.

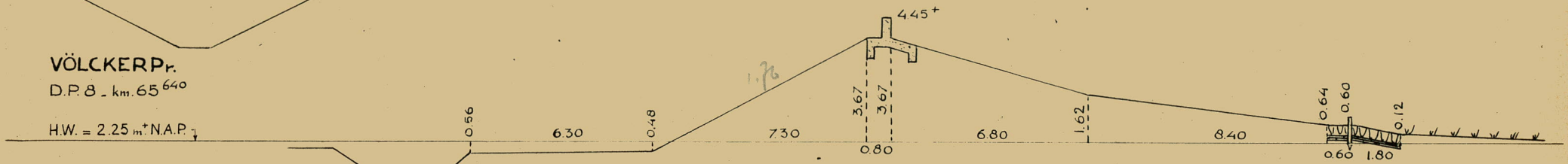

ANNA MARIA Pr.

D.P. 23 - km. 68⁰⁹⁰

H.W. = 2.25 m⁺ N.A.P.

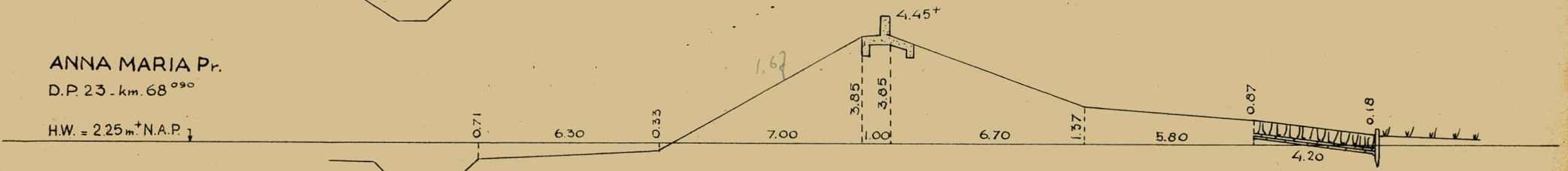

ANNA MARIA Pr.

D.P. 41 - km. 69⁸⁹⁰

H.W. = 2.25 m⁺ N.A.P.

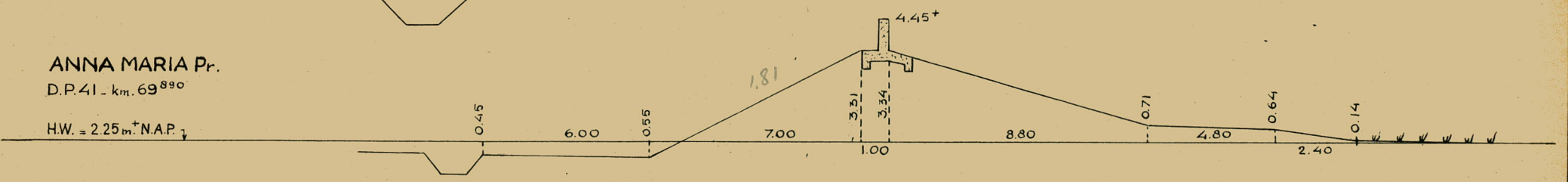

BULAGE 31

SITUATIE WALCHEREN

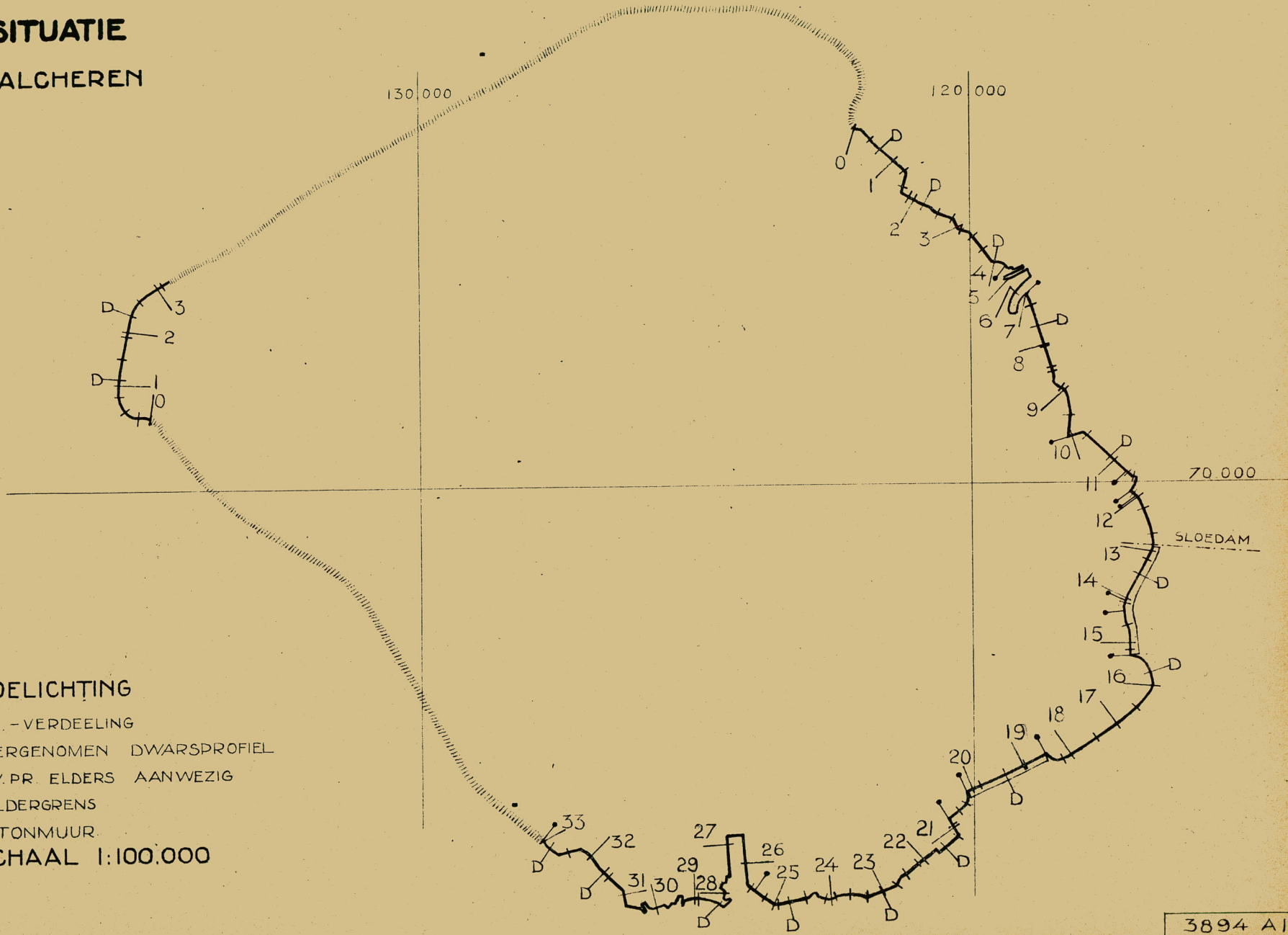

TOELICHTING

Km. - VERDEELING

OVERGENOMEN DWARSPROFIEL

DW. PR. ELDERS AANWEZIG

POLDERGRENS

BETONMUUR

SCHAAL 1:100.000

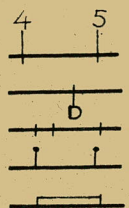

GEM. DUKSKRUINHOOGTE PER k.m.

WALCHEREN

WATERPASSING 1917-1919
BUGEWERKT TOT JAN. 1943.

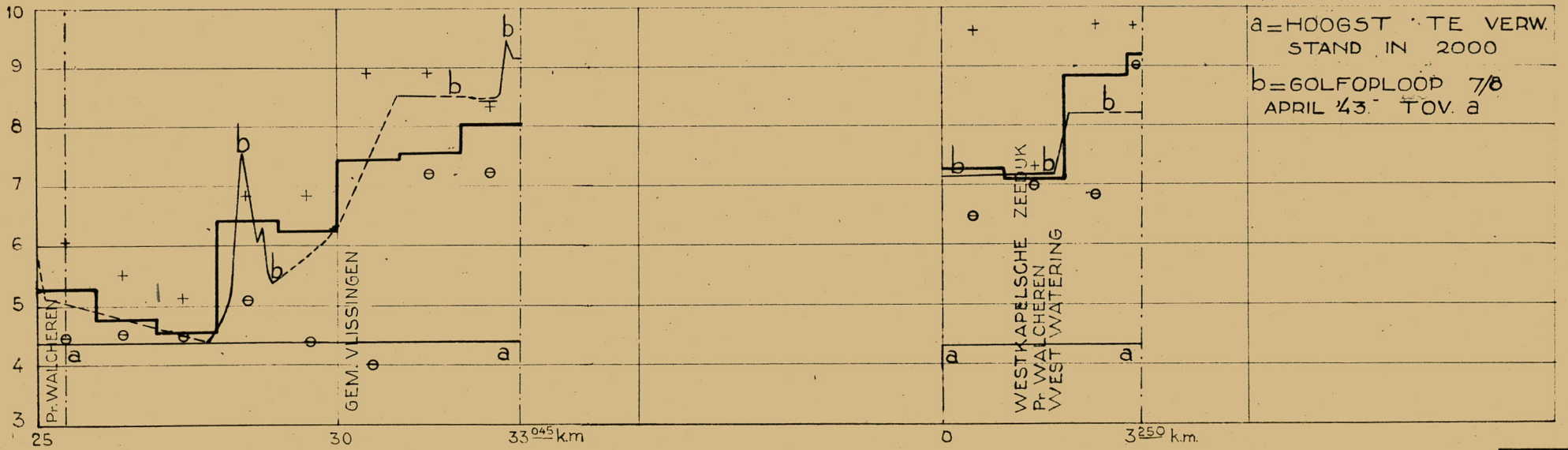
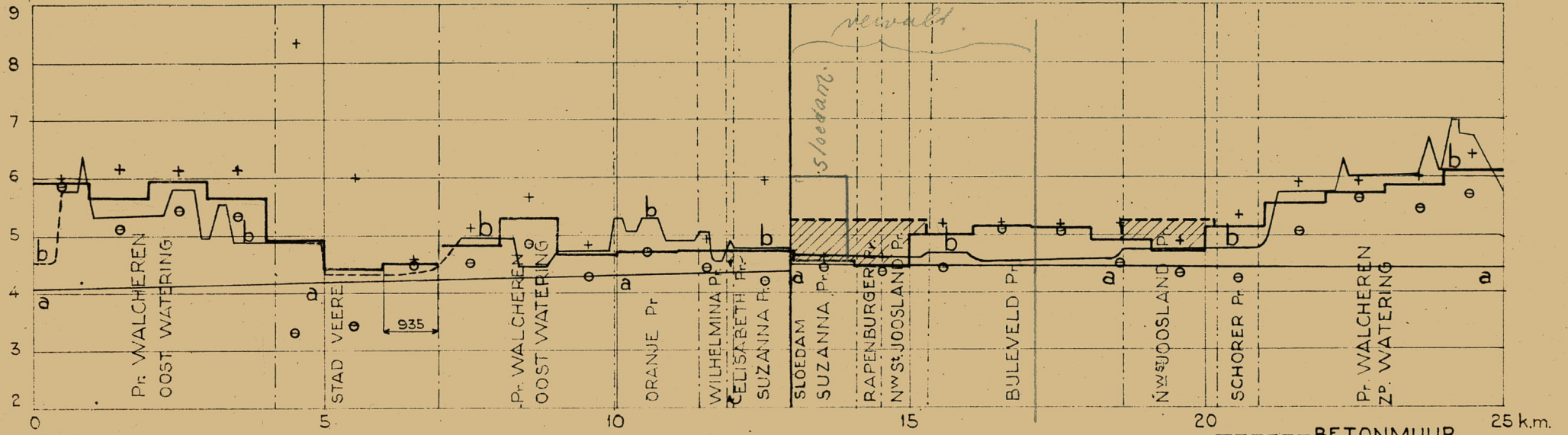

BULAGE 3.1

DWARSPROFIELEN WALCHEREN (1)

SCHAAL 1:200

WESTKAPELSCH ZEEDUK

DP. 11 - km. 1¹¹⁰

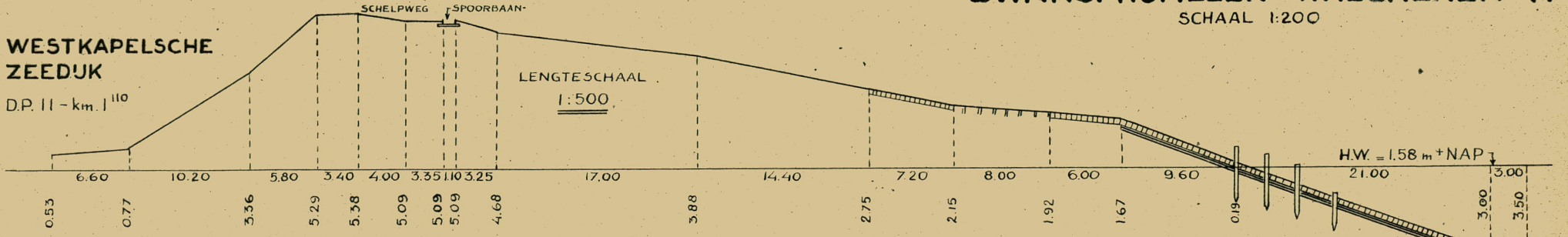

WESTKAPELSCH ZEEDUK

DP. 23 - km. 2³⁰⁰

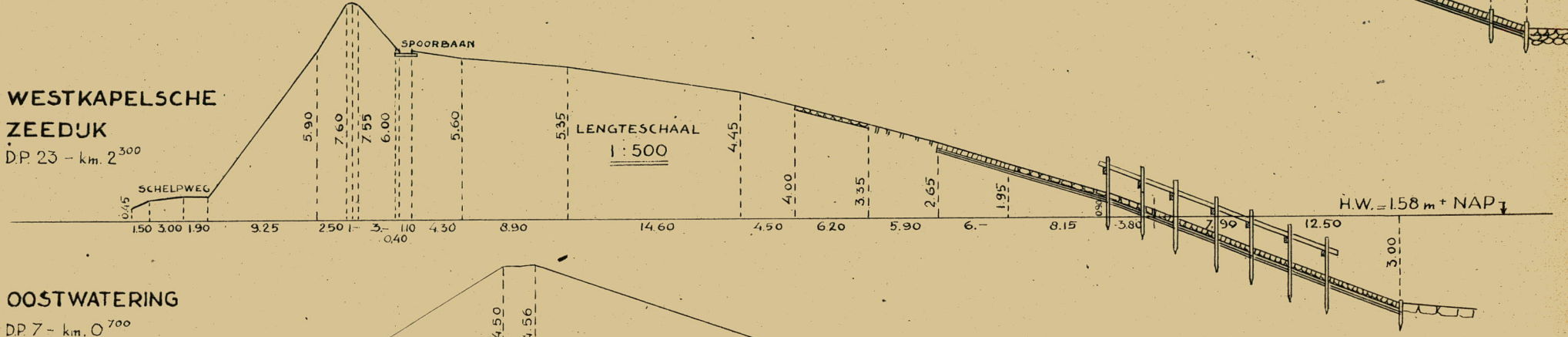

OOSTWATERING

DP. 7 - km. 0⁷⁰⁰

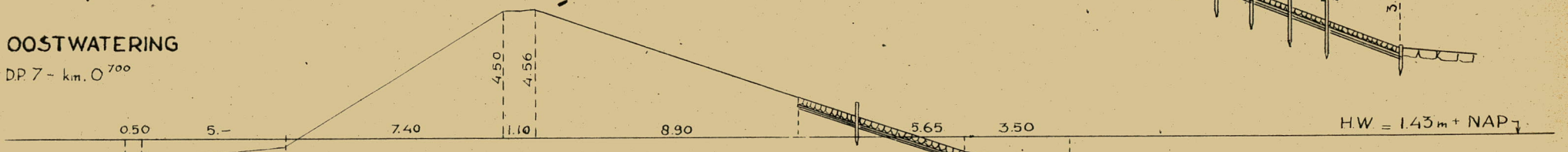

OOSTWATERING

DP. 22 - km. 2²⁰⁰

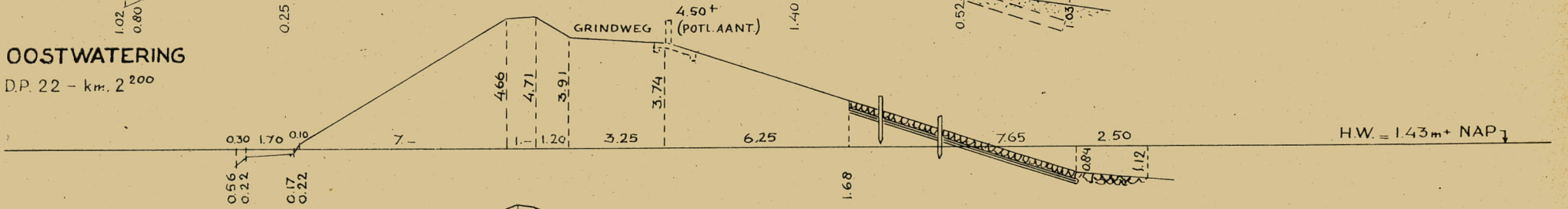

OOSTWATERING

DP. 40 - km. 4⁰⁰⁰

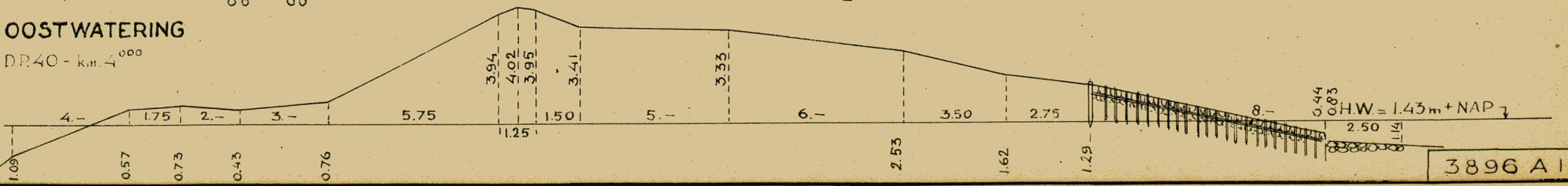

BULAGE 34

DWARSPROFIELEN WALCHEREN (2)

SCHAAL 1:200

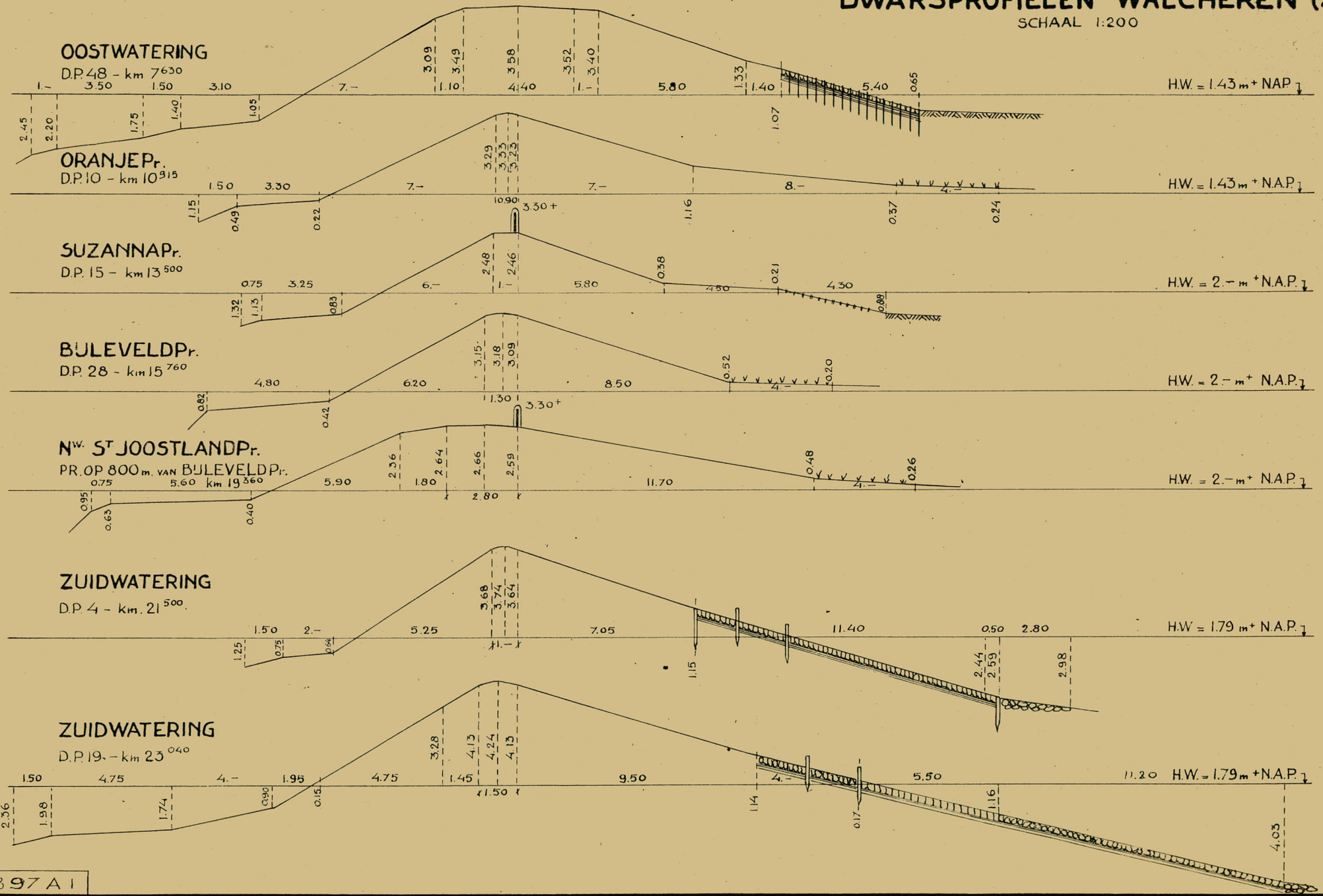

BULAGE 35

DWARSPROFIELEN WALCHEREN (3 SLOT)

SCHAAL 1:200

ZUIDWATERING

D.P. 36 - km 24⁷¹⁰

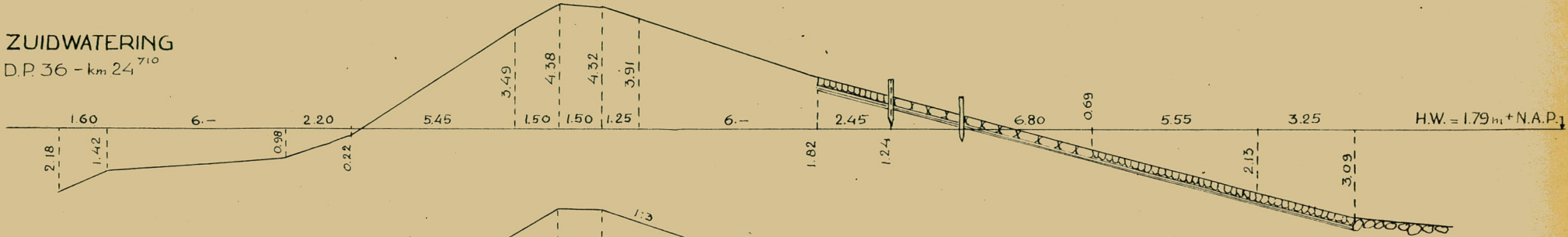

ZUIDWATERING

55 m VOORBUJ D.P. 48 - km 28⁴⁹⁰

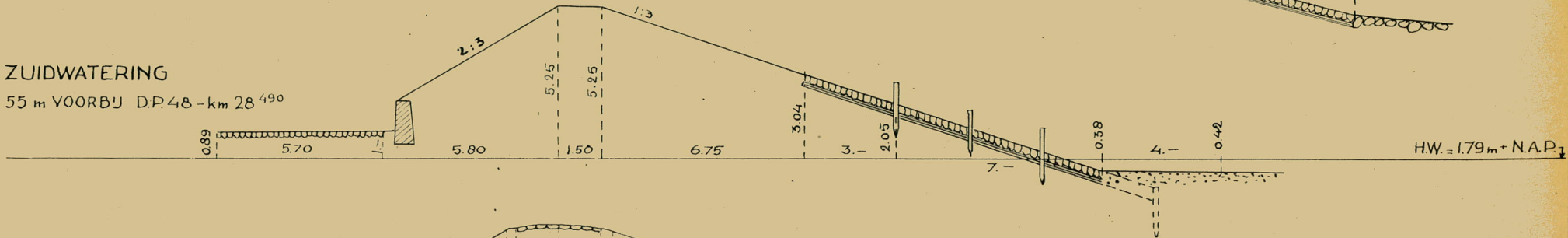

WESTWATERING

D.P. 5 - km 31⁵⁹⁰

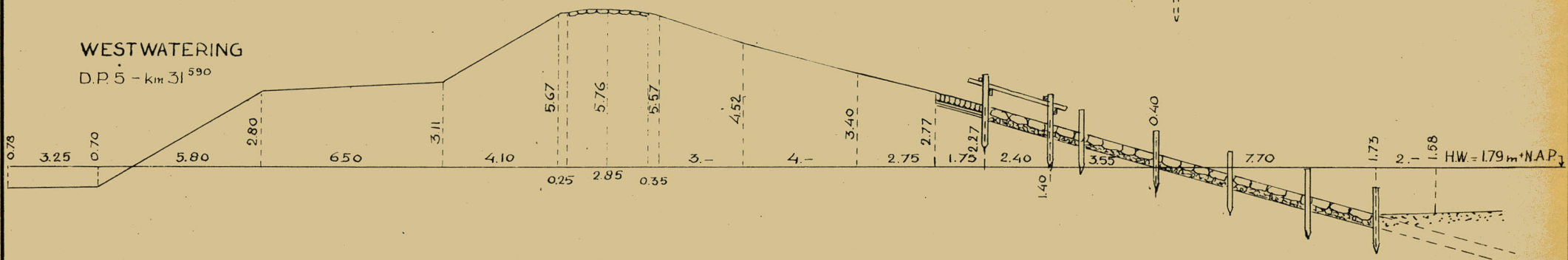

WESTWATERING

D.P. 18 - km 32⁸³⁰

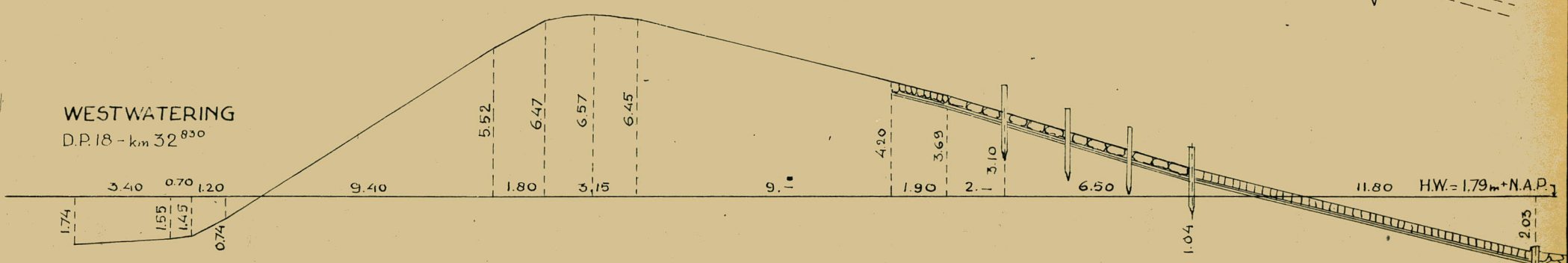

BULAGE 35

SITUATIE

NOORD BEVELAND

110.000

60.000

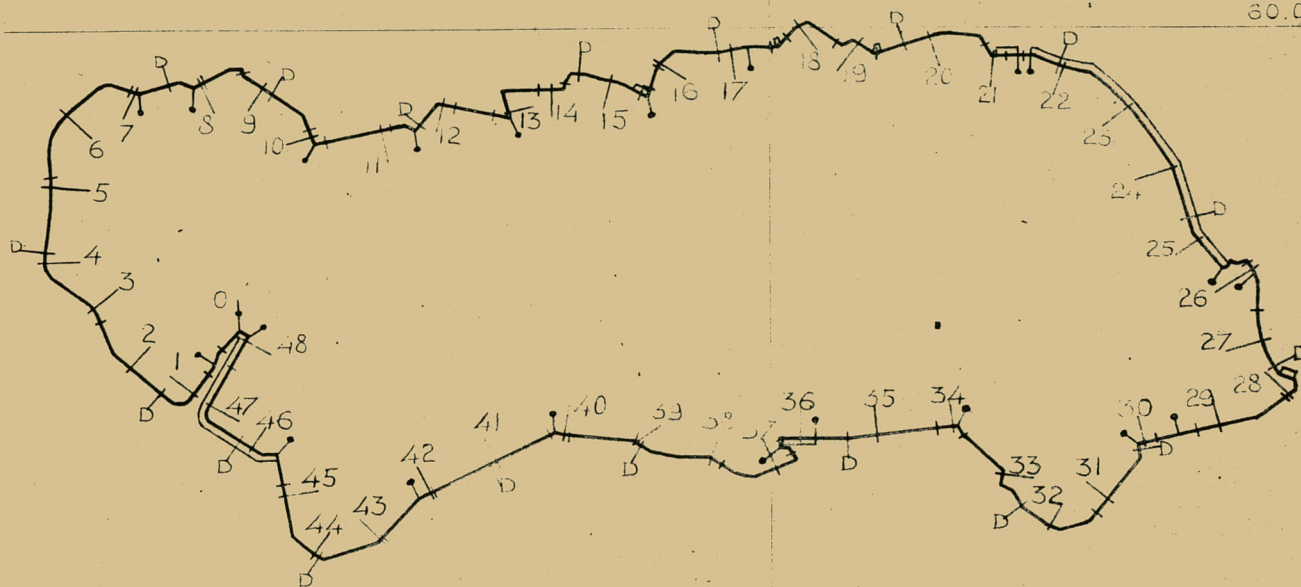

TOELICHTING



km VERDEELING



OVERGENOMEN, DWARSPROFIEL

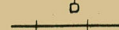

DW. PR. ELDERS AANWEZIG



BETONMUUR

SCHAAL 1:100.000

3889 A I

GEM. DIJKSKRUIJN HOOGTE PER K.M.

WATERPASSING NAJAAR 1919
BUGEWERKT TOT JAN 1943

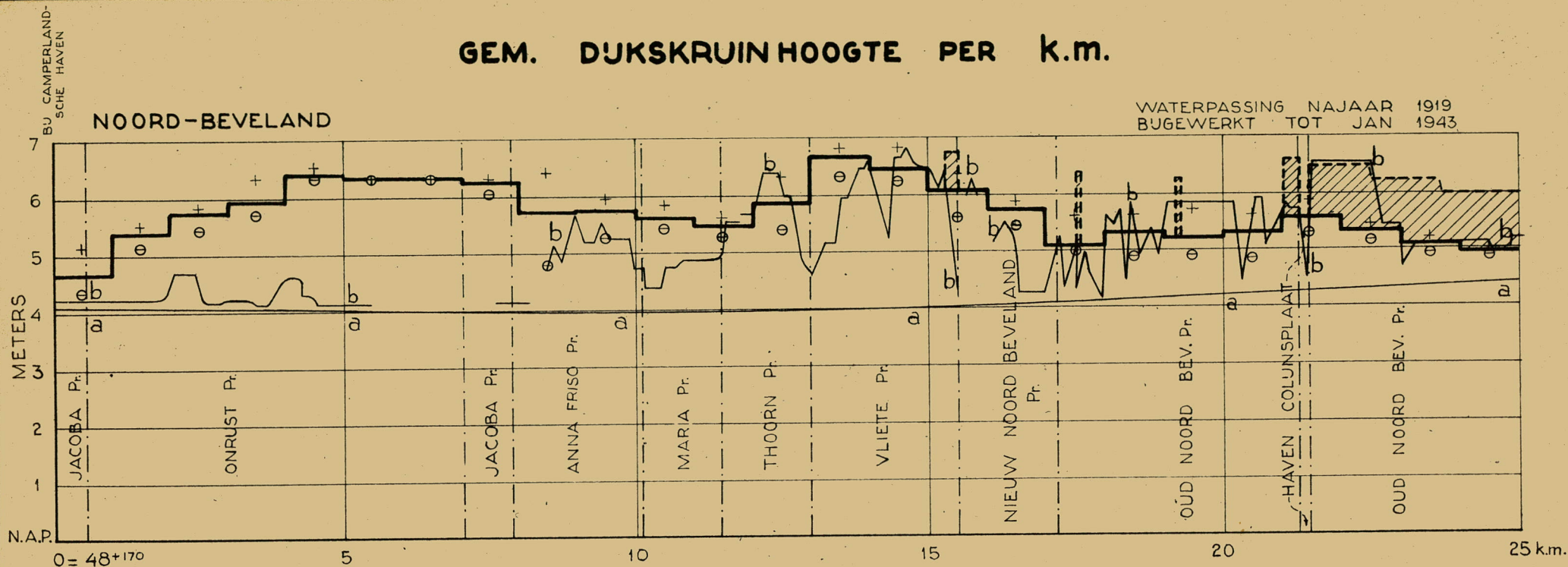

a = HOOGST TE VERW. STAND IN 2000. b = GOLFOPLOED 7/8 APRIL '43. TOV. a

BETONMUUR

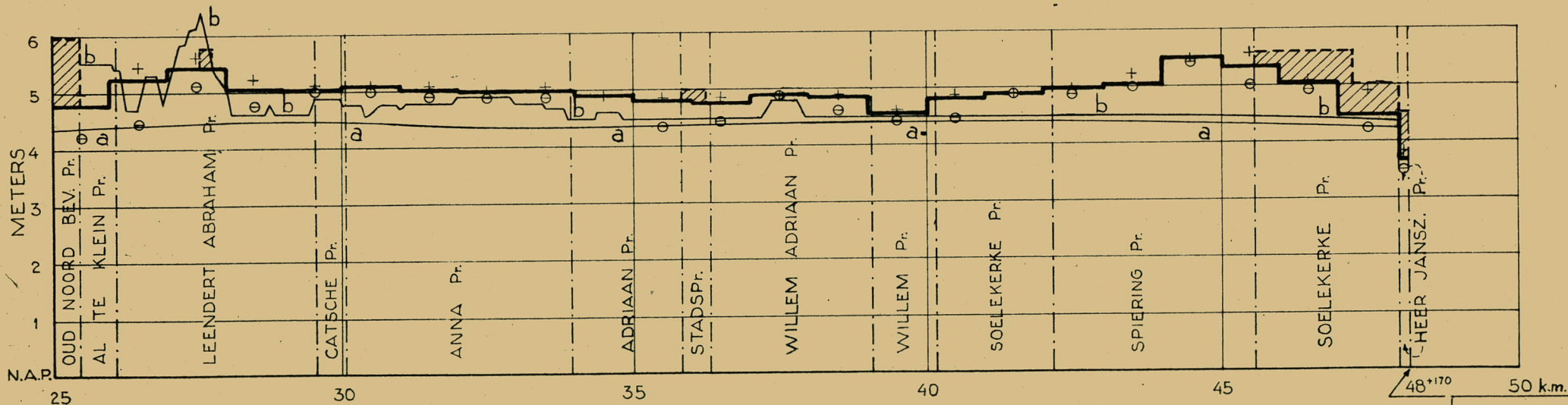

48+170

3890 A 1

DWARSPROFIELEN N^o BEVELAND (1)

SCHAAL 1:200

ONRUSTP_r
D.P. 55 km.1⁵⁵⁰

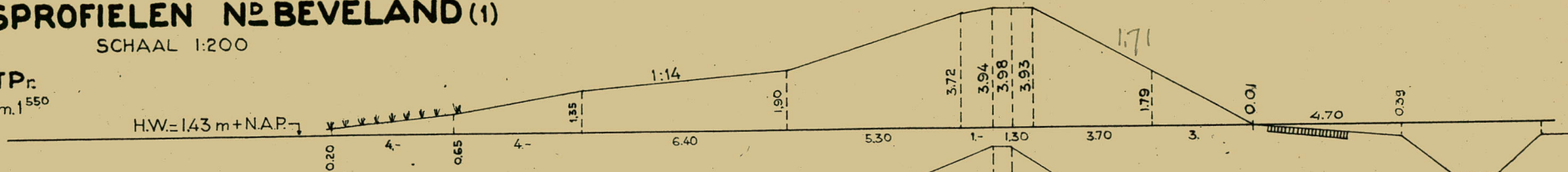

ONRUSTP_r
D.P. 29 km 4¹⁴⁰

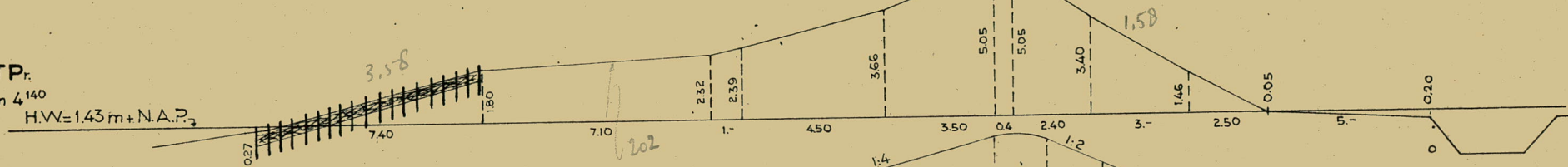

JACOBP_r
D.P. 5 km.7⁵²⁵



ANNA FRISOP_r
D.P. 13 km 9¹⁵⁵

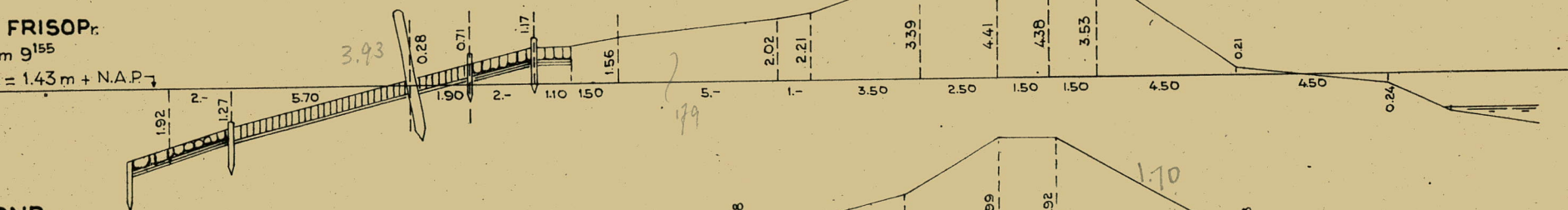

THOORNP_r
D.P. 14 km.11⁵⁷⁰

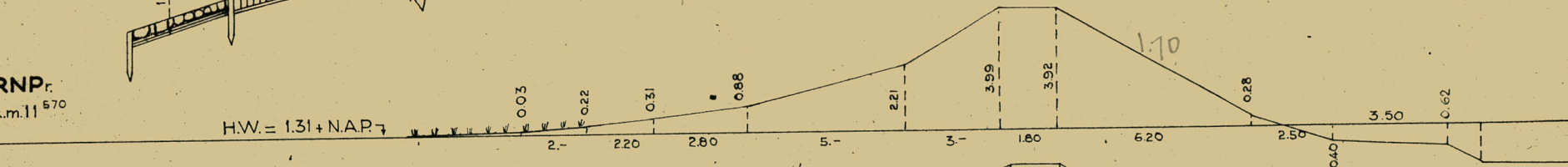

VLIETEP_r
D.P. 12 km.14³⁵⁰

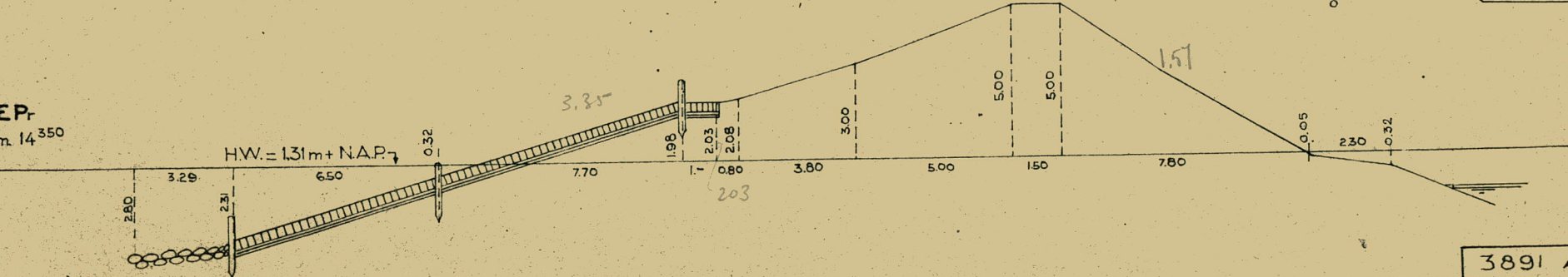

BULAGE

DWARSPROFIELEN N^o BEVELAND (2)

SCHAAL 1:200

N^o N^o BEVELAND Pr.

D.P. 13-km 16⁸²⁵

H.W. = 1.31 m + NAP

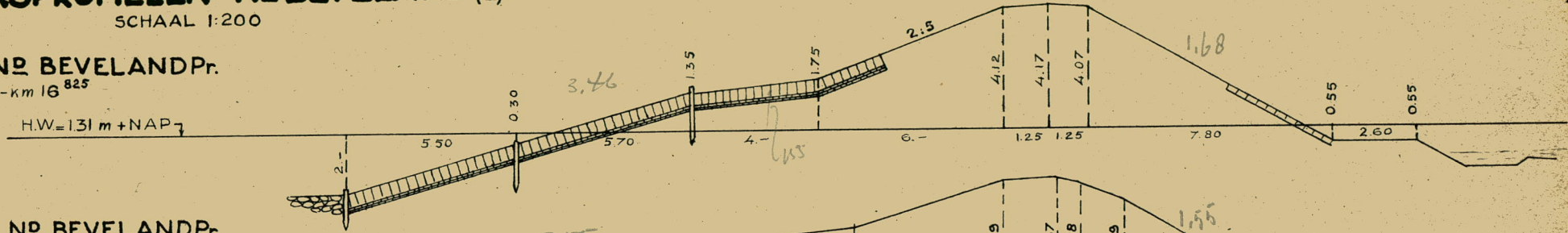

OUDE N^o BEVELAND Pr.

D.P. 25-km 19⁶⁶⁰

H.W. = 1.31 m + NAP

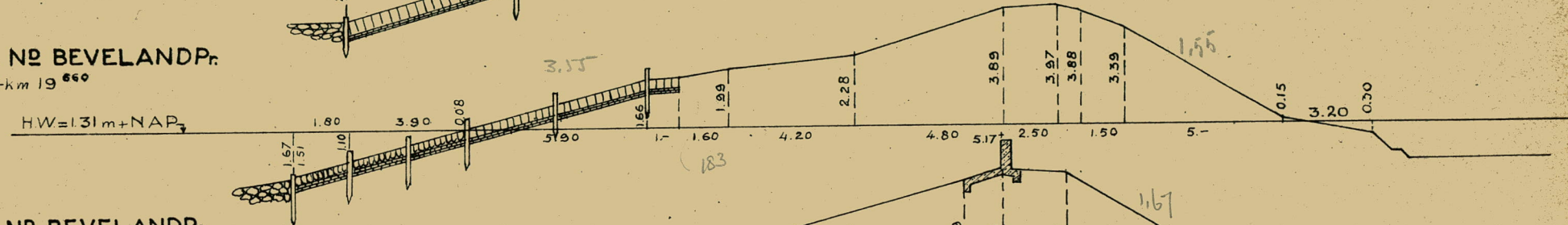

OUDE N^o BEVELAND Pr.

D.P. 48-km 21⁹⁶⁰

H.W. = 1.31 m + NAP

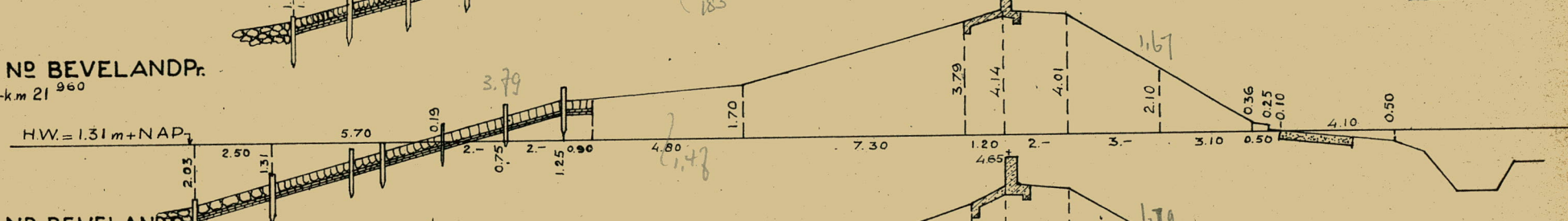

OUDE N^o BEVELAND Pr.

D.P. 75-km 24⁶⁶⁰

H.W. = 1.31 m + NAP

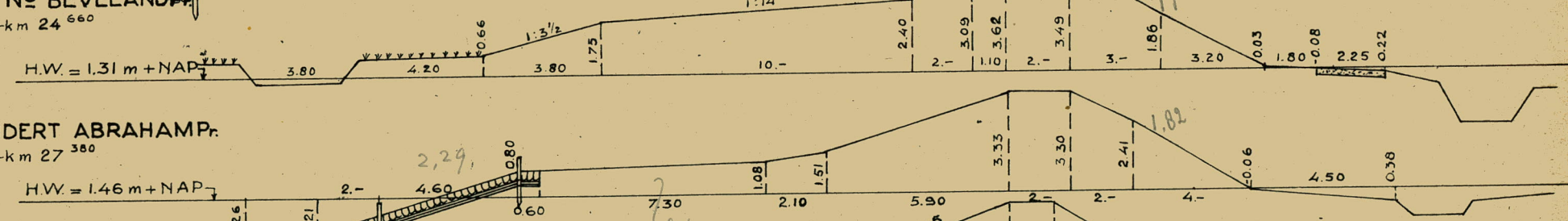

LEENDERT ABRAHAM Pr.

D.P. 13-km 27³⁸⁰

H.W. = 1.46 m + NAP

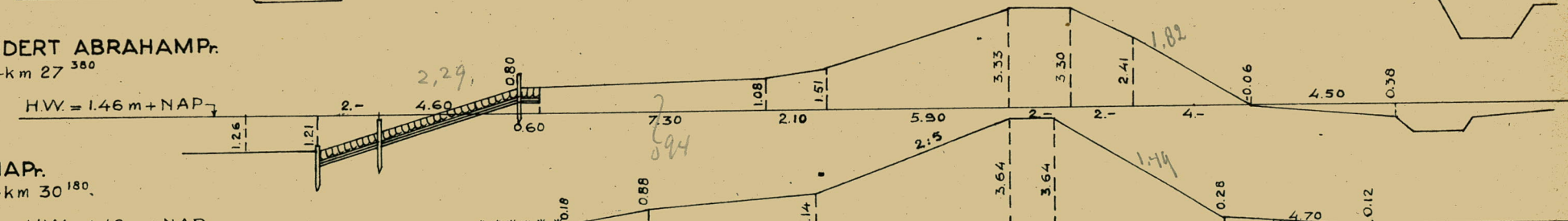

ANNAPr.

D.P. 1-km 30¹⁸⁰

H.W. = 1.46 m + NAP

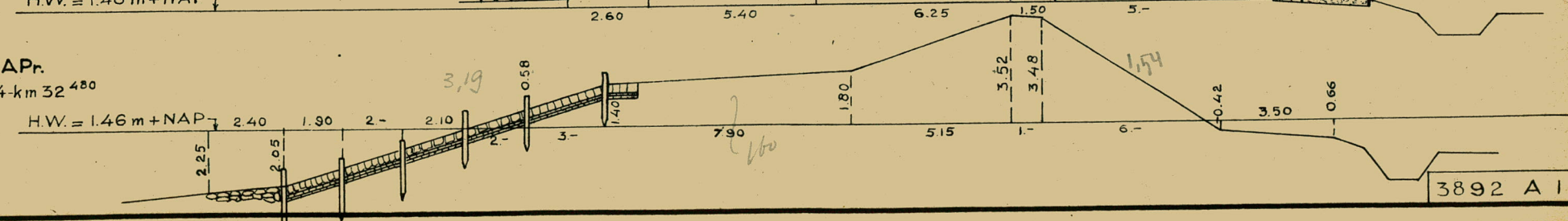

ANNAPr.

D.P. 24-km 32⁴⁸⁰

H.W. = 1.46 m + NAP

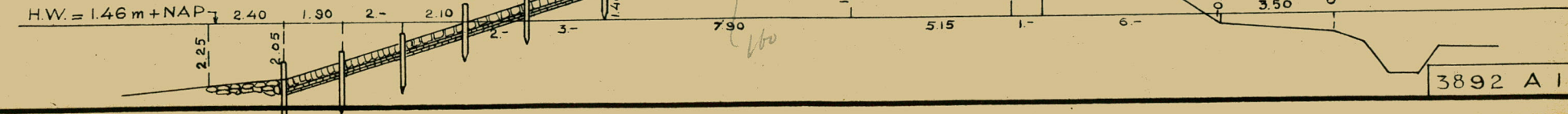

BULAGE 40

DWARSPROFIELEN NO BEVELAND (3 SLOT)

SCHAAL 1:200

ADRIAANPr.

D.P. 4 - km. 35⁴⁰⁰

H.W. = 1.44 m + NAP

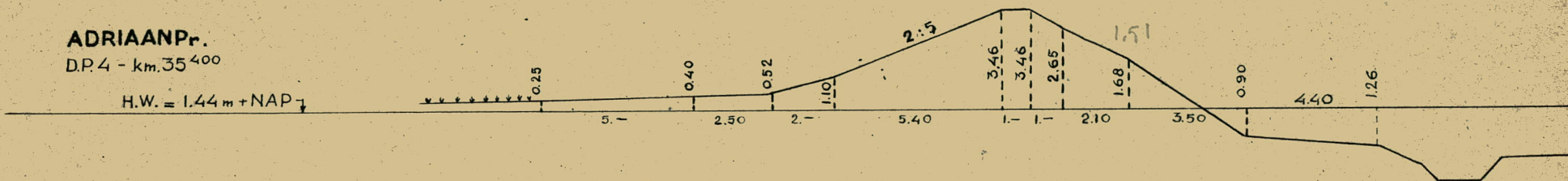

WILLEM ADRIAANPr.

D.P. 26 - km. 38⁹²⁰

H.W. = 1.44 m + NAP

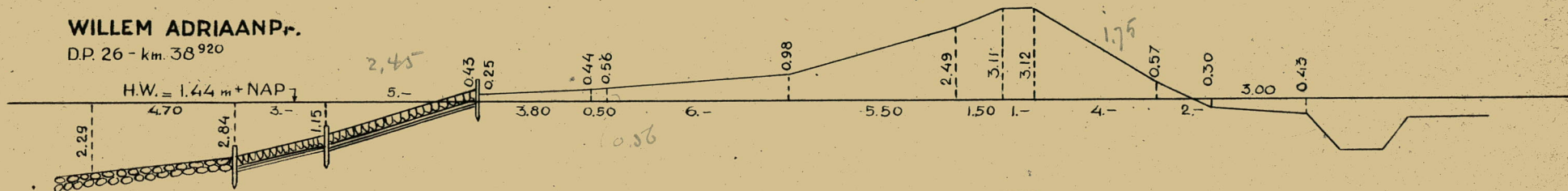

SOELEKERKEPr.

10 m VOORBUJ D.P. 9 - km. 41¹⁰⁰

H.W. = 1.44 m + NAP

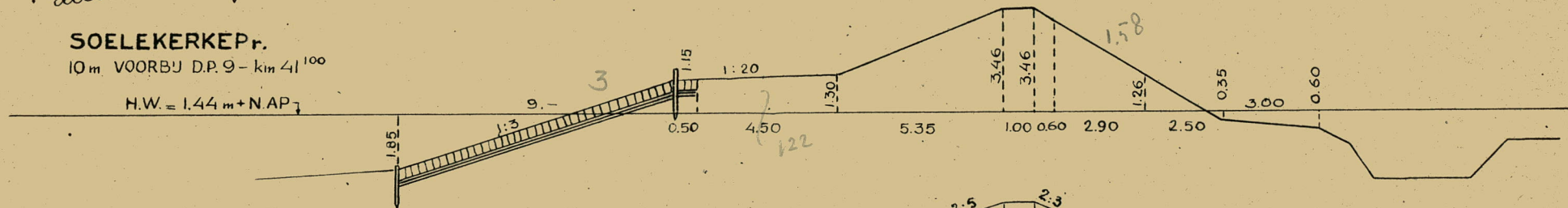

SPIERINGPr.

30 m VOOR PIKET M, km. 43⁹²⁵

H.W. = 1.43 m + NAP

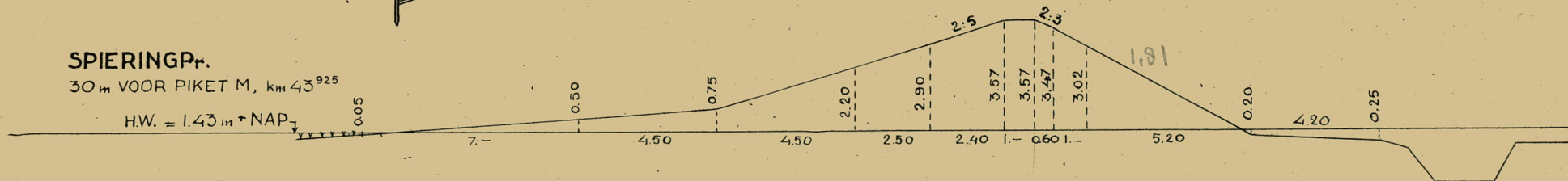

SOELEKERKEPr.

D.P. 27 - km. 46¹⁸⁰

H.W. = 1.43 m + NAP

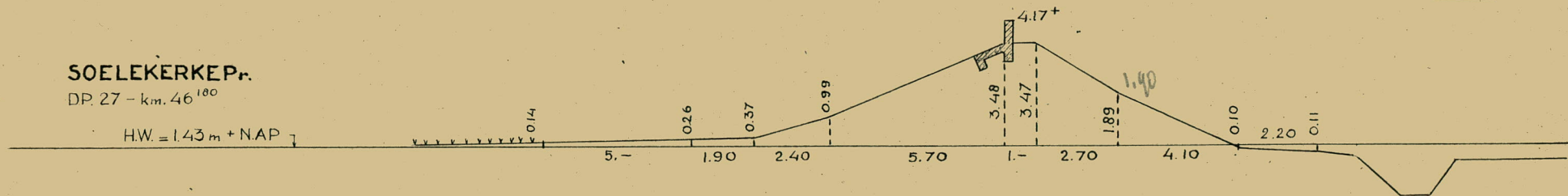

BULAGE

SITUATIE

THOLEN EN S^t. PHILIPSLAND

90.000



60.000

TOELICHTING



K.M.-VERDEELING



OVERGENOMEN DWARSPROFIEL

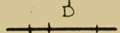

DWARSPROFIEL ELDERS AANWEZIG

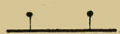

POLDERGRENS

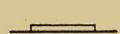

BETONMUUR

SCHAAL 1:100.000

3878 A I

BIJLAGE

42

GEM. DIJKSKRUINHOOGTE PER k.m.

WATERPASSING 1919 - '20
BUGEWERKT TOT 1 JAN 1943

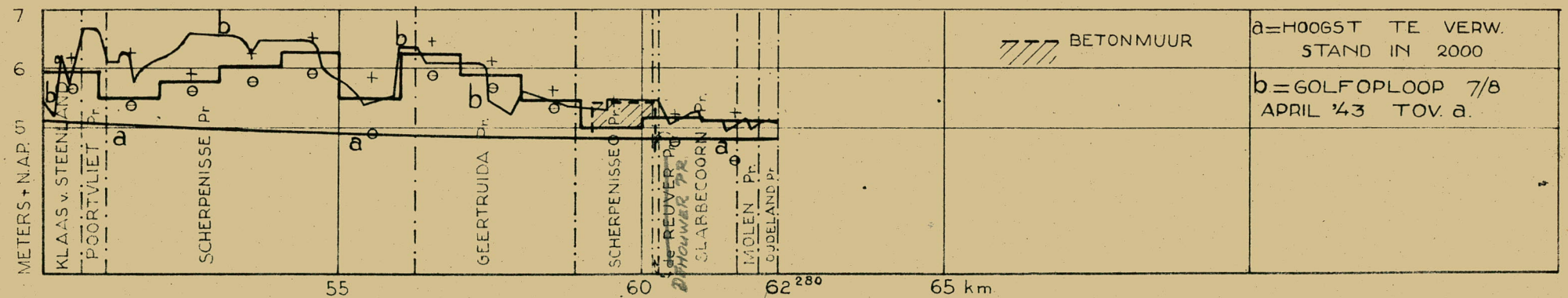
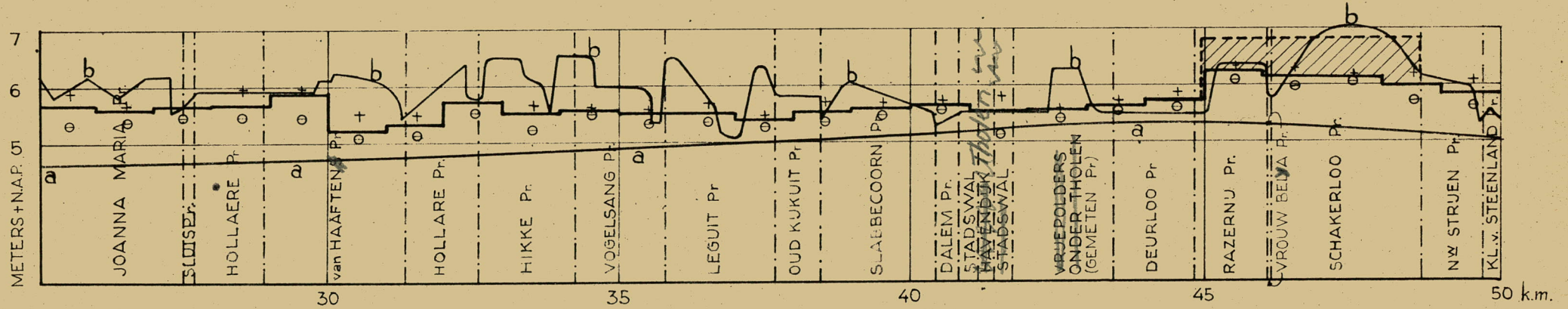
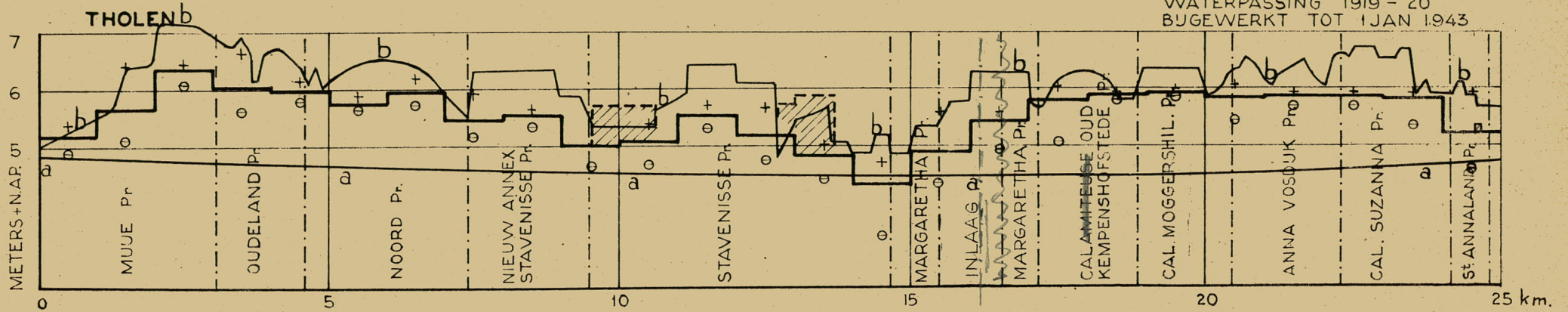

BETONMUUR

a=HOOGST TE VERW. STAND IN 2000

b=GOLFOPLOOP 7/8 APRIL '43 TOV. a.

BULAGE 43

DWARSPROFIELEN THOLEN (1)

SCHAAL 1:200

MUYEP_r.

D.P. 6 - km. 0⁵⁹⁰

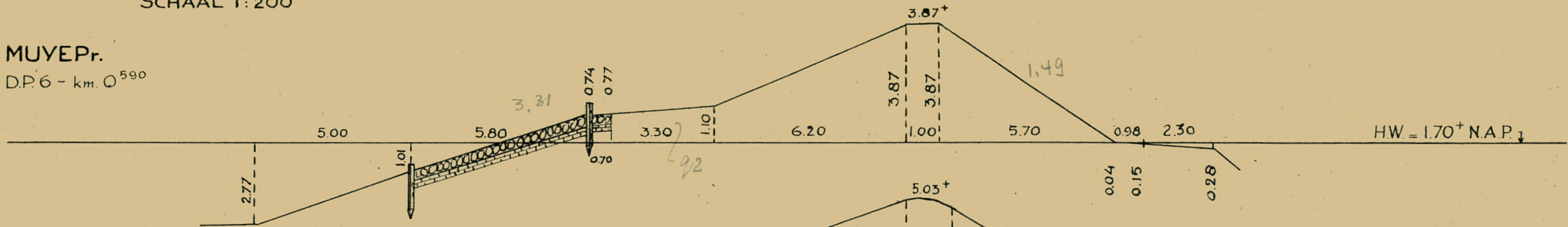

MUYEP_r.

D.P. 25 - km. 2⁴⁹⁰

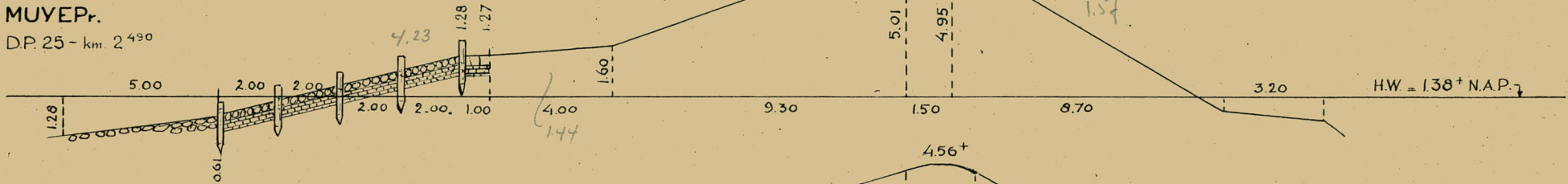

OUDELANDP_r.

D.P. 10 - km. 4⁰⁵⁰

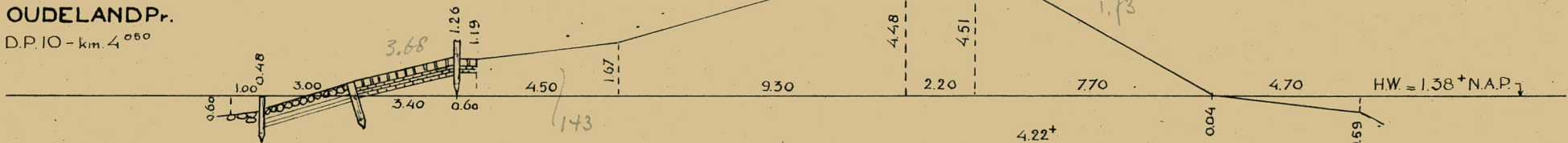

NOORDP_r.

D.P. 17 + 45 m. - km. 6³³⁰

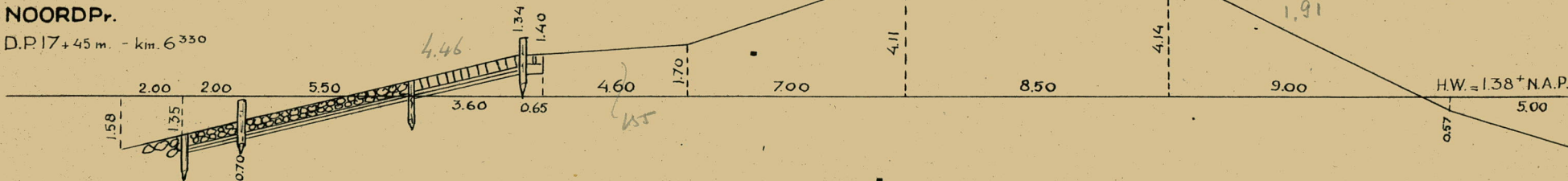

NW ANNEX-STAVENISSEP_r.

D.P. 11 - km. 8⁵⁰⁰



BILAGE 44

DWARSPROFIELEN THOLEN (2)

SCHAAL 1:200

STAVENISSE Pr.

DP.15 - km. 11⁰³⁰

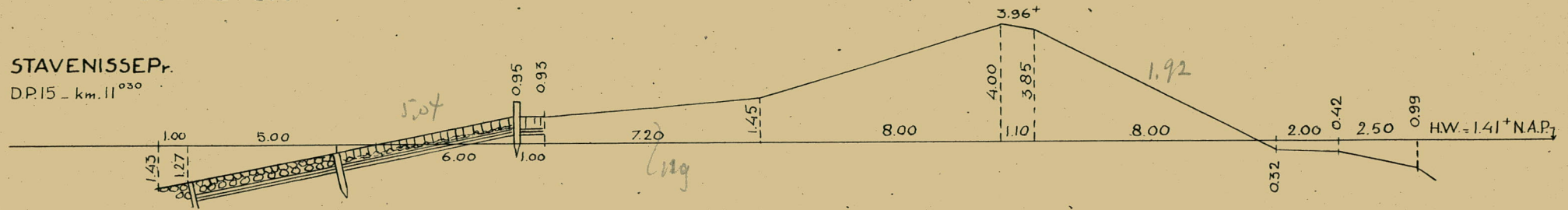

STAVENISSE Pr.

DP.38 - km. 13³¹⁰

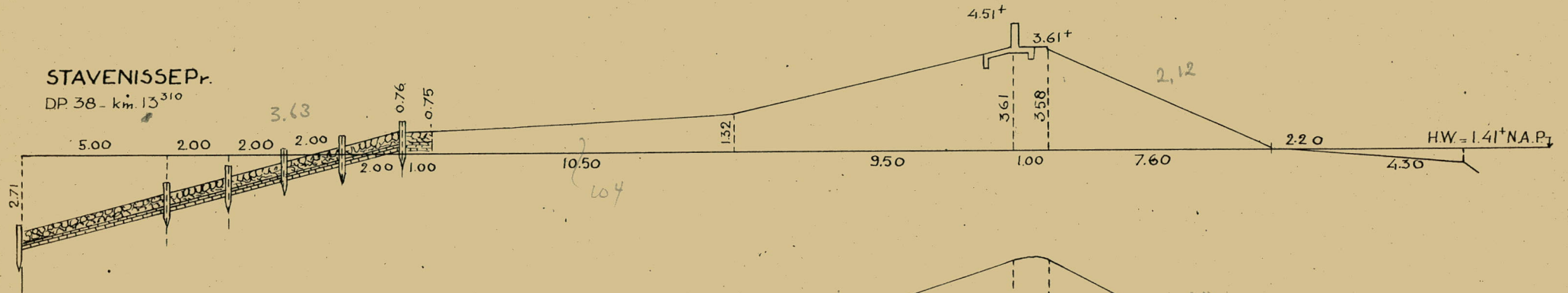

MARGARETHA Pr.

D.P.73 - km. 16⁷⁶⁰

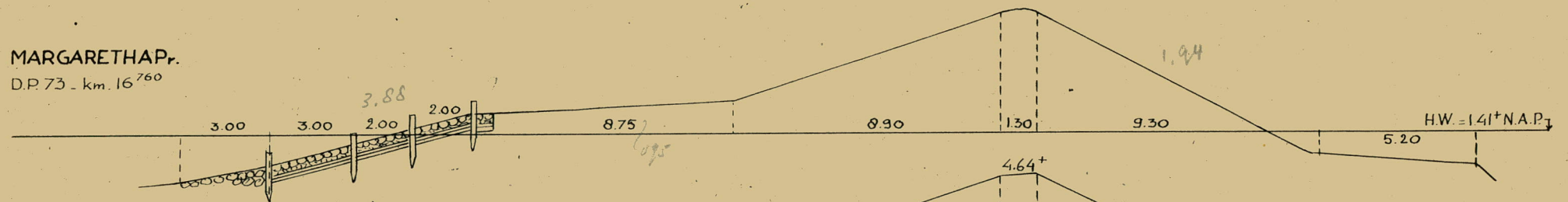

CAL. OUDKEMPENSHOFSTED Pr.

D.P.15 - km. 18⁶⁷⁰

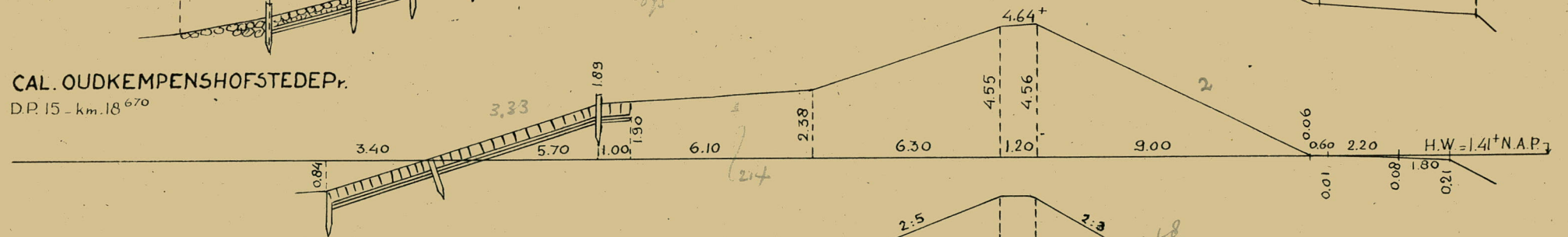

ANNA VOSDUK Pr.

D.P.9 - km. 21⁵²⁵

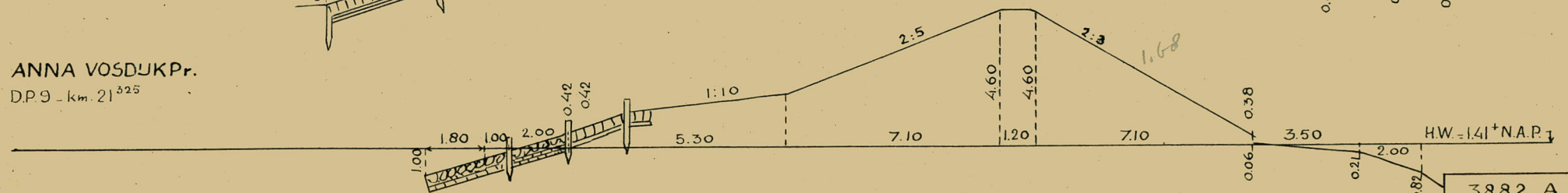

DWARSPROFIELEN THOLEN (3)

SCHAAL 1:200

CAL. SUZANNAPr.
D.P. 16 + 85 m - km 23⁹⁴⁰

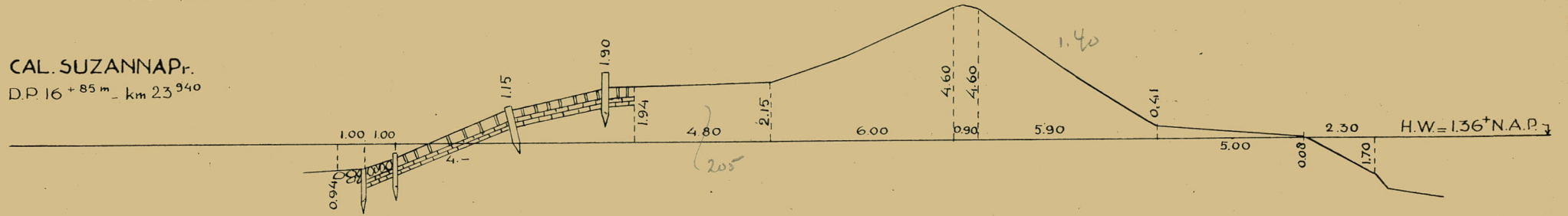

JOANNA MARIAPr.
D.P. 6 - km 25⁵⁰⁰

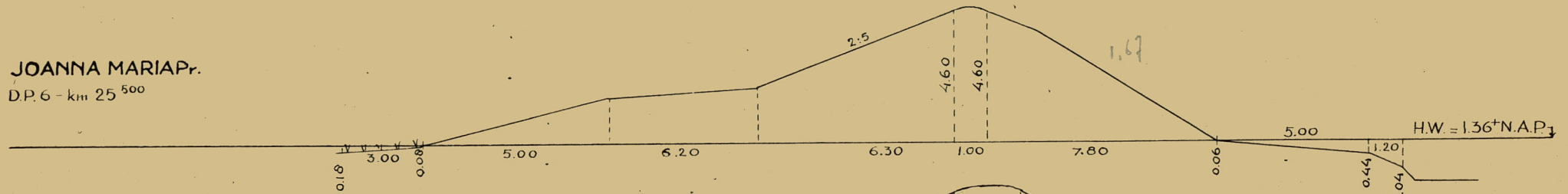

HOLLAREPr.
D.P. 21 - km 28⁵⁵⁰

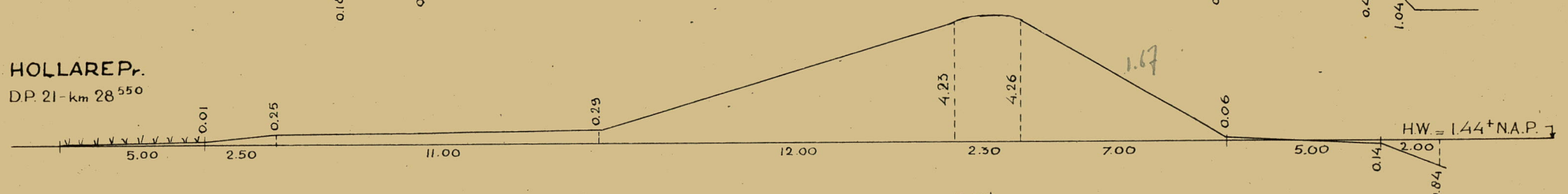

VAN HAAFTENPr.
D.P. 9 + 30 m - km 30⁴⁵⁰

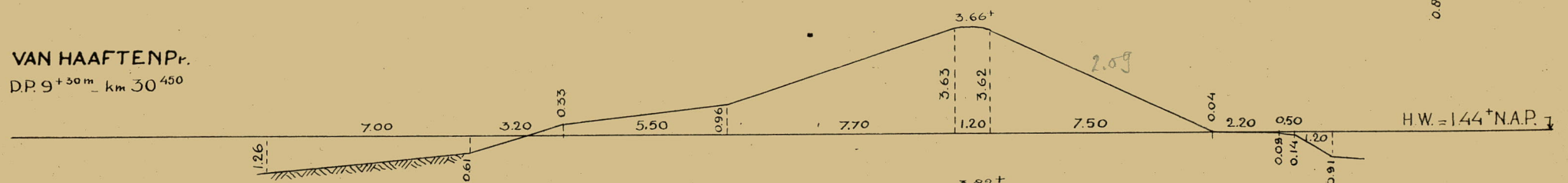

HIKKEPr.
D.P. 6 - km 33²⁰⁰

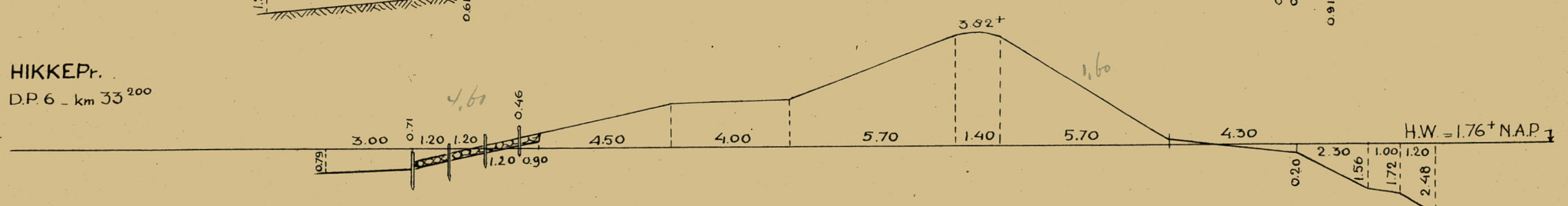

BILAGE

DWARSPROFIELEN THOLEN (4)

SCHAAL 1:200

VOGELSPANGPr.

D.P. 25 - km 35⁰⁸⁵

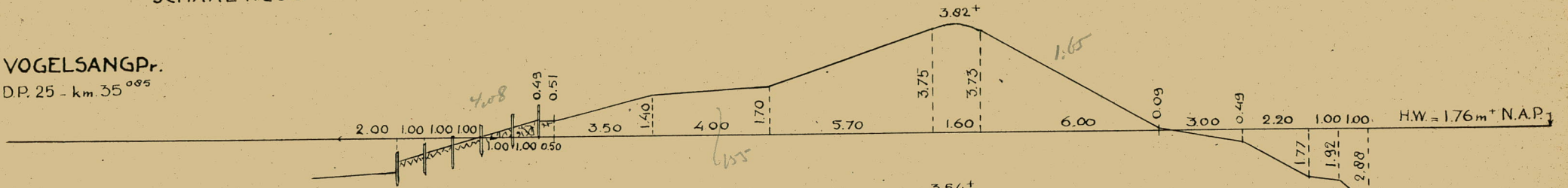

LEGUITPr.

D.P. 50 - km 37⁵⁸⁵

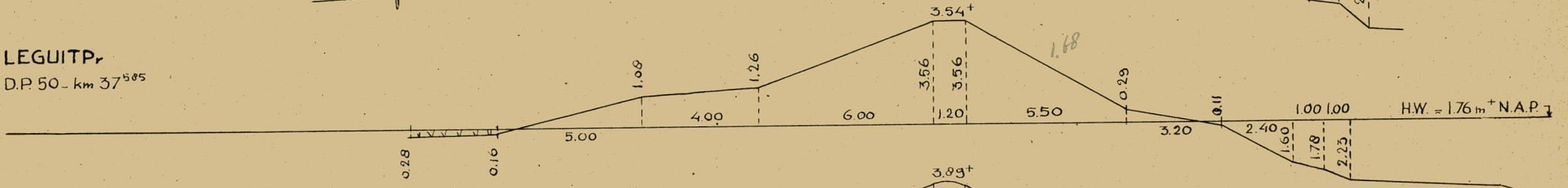

SLABBECOORNPr.

D.P. 76 - km 40¹⁷⁵

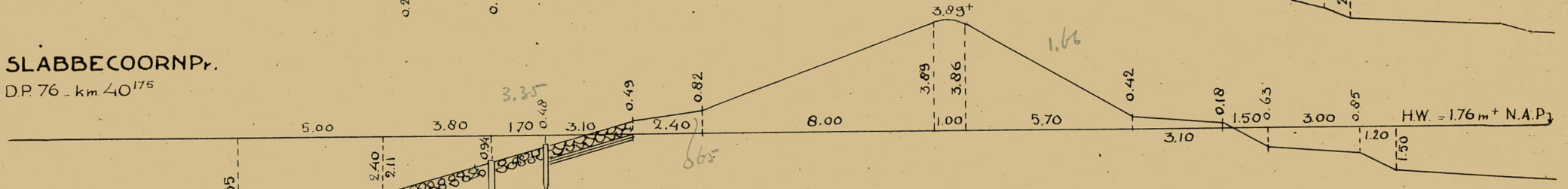

GEMETENPr.

D.P. 5 - km 42¹²⁰

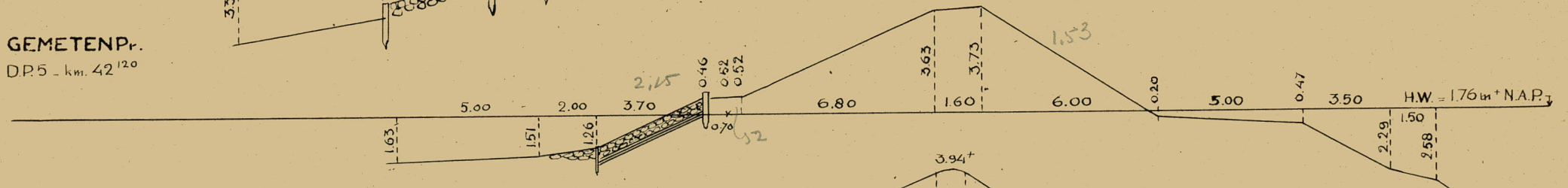

DEURLOOPPr.

D.P. 13 - km 44⁷²⁵

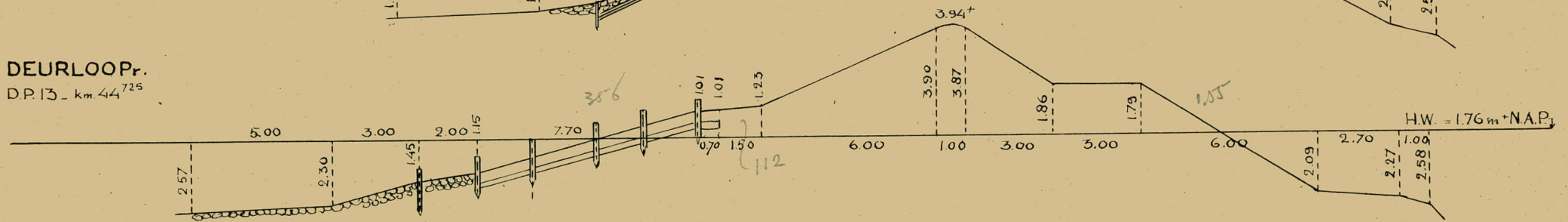

BULAGE