

MEERDIJK NOORDOOSTPOLDER ZUIDERZEEWERKEN 1940

PROF. 3

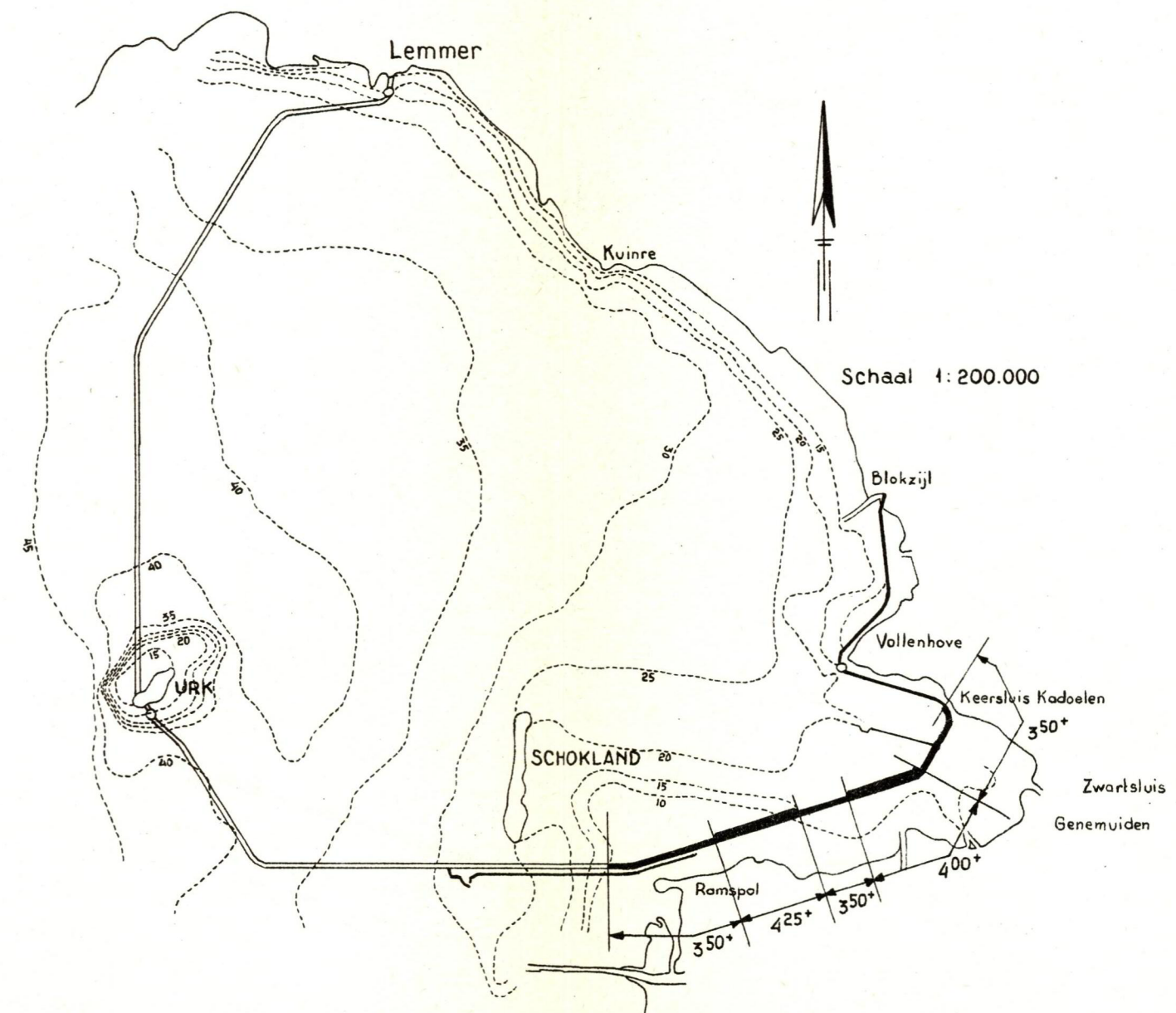
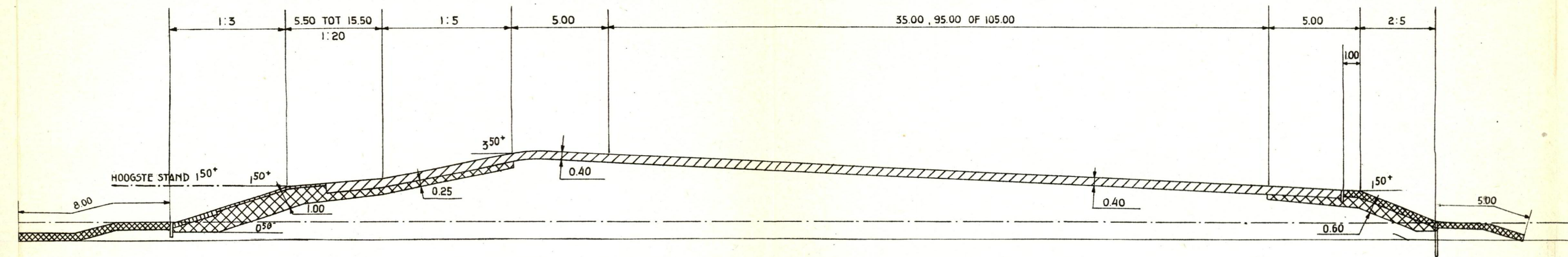

VERHOOGING FRIESCHE ZEEDIJKEN ZUIDERZEEWERKEN 1928
GEDEELTE AFSLUITDIJK-ZURIG PROFIEL I

PROF. 4

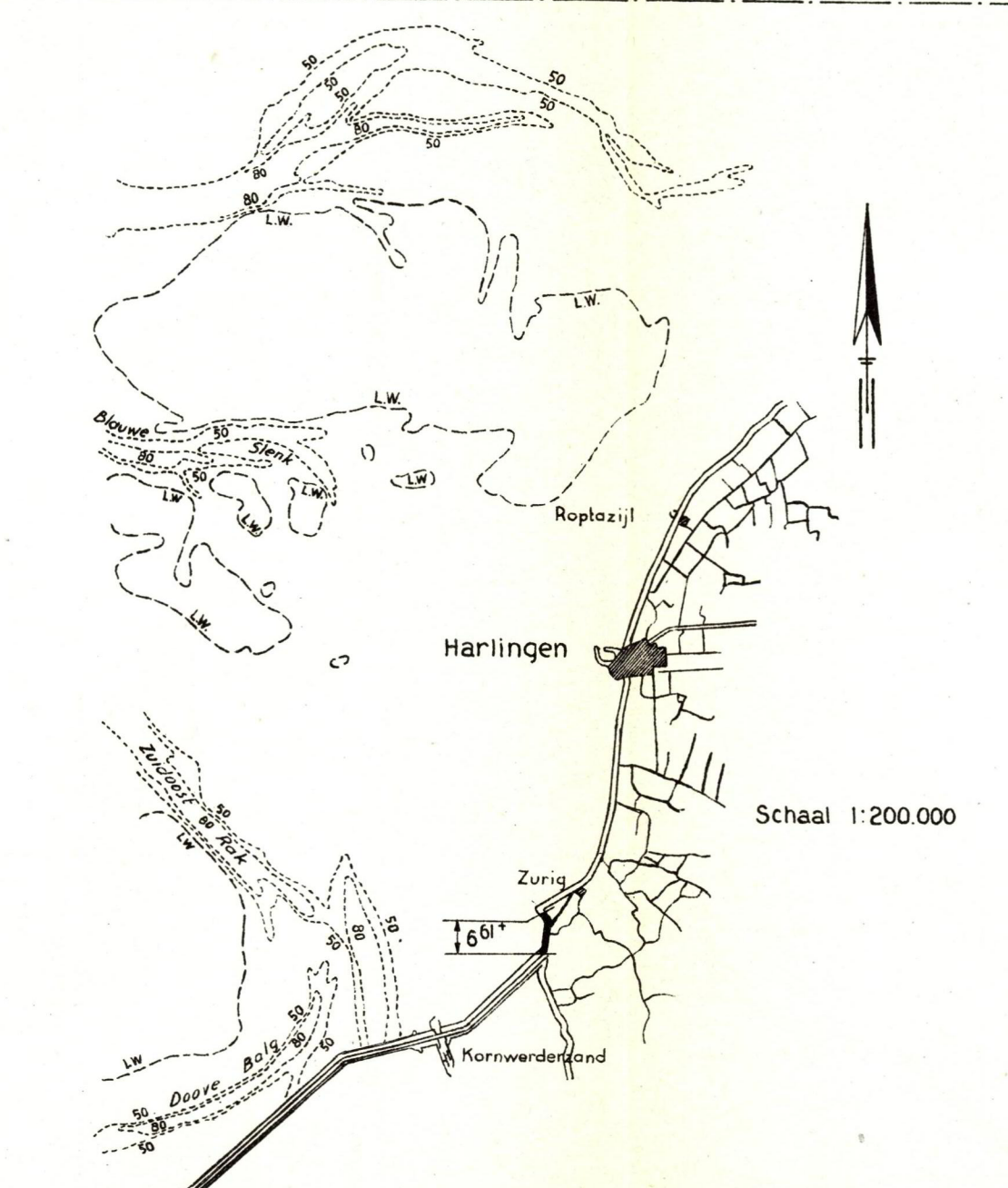
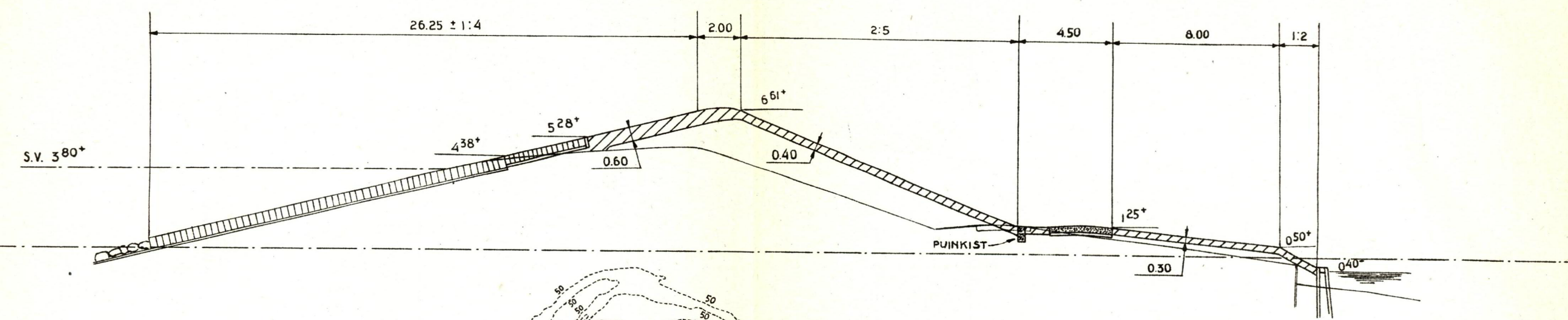

VERHOOGING FRIESCHE ZEEDUKEN ZUIDERZEEWERKEN 1928
 GEDEELTE AFSLUITDIJK - ZURIG PROFIEL 2

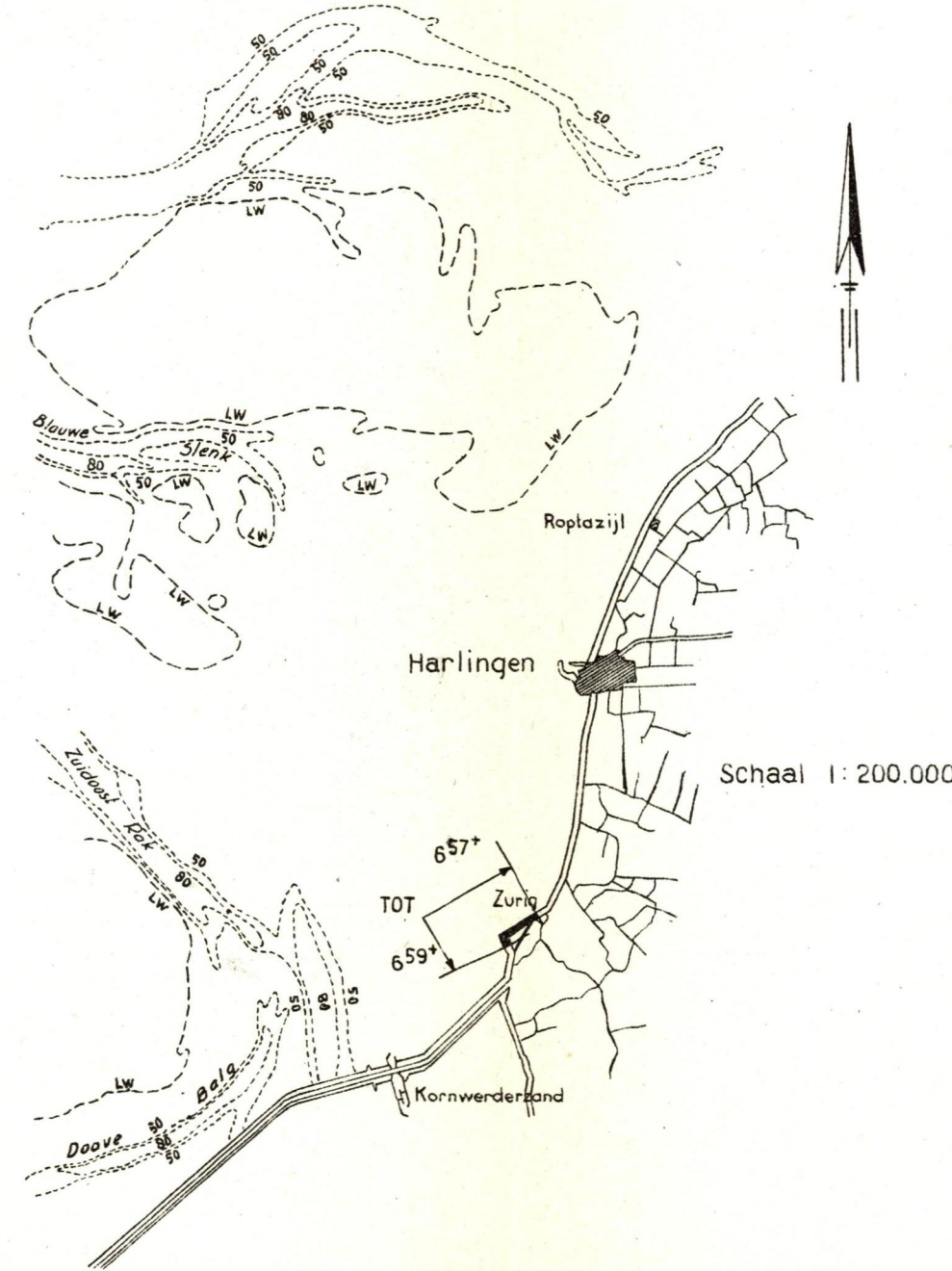
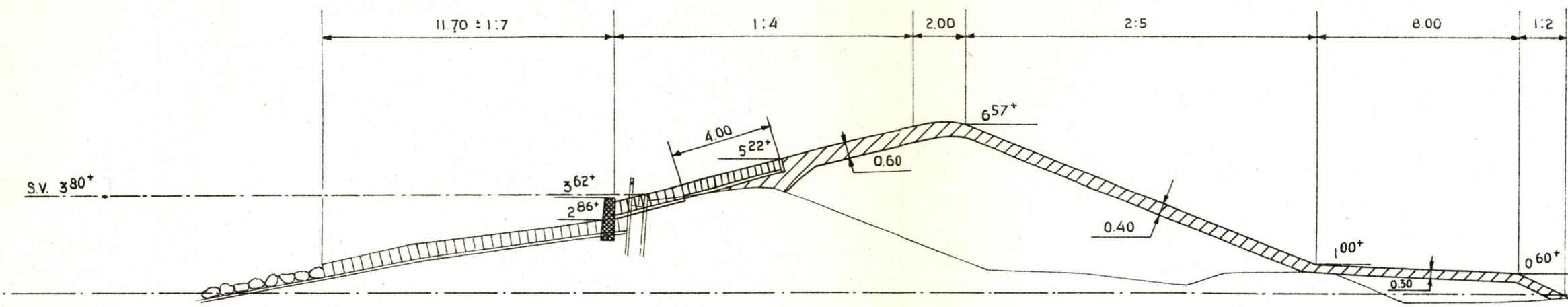

PROF. 5

VERHOOGING FRIESCHE ZEEDUKEN ZUIDERZEEWERKEN 1929-1930
 GEDEELTE ZURIG - HARLINGEN

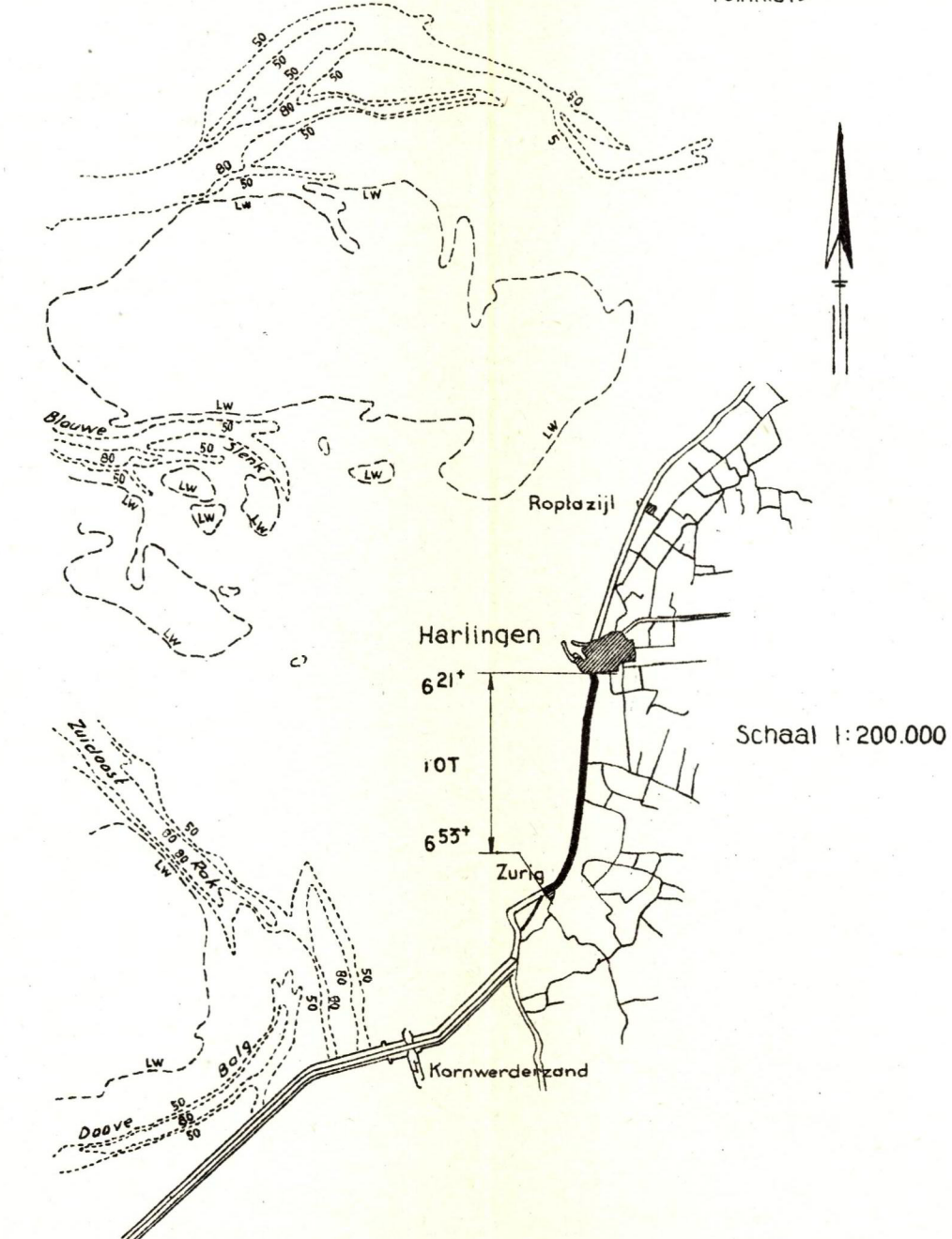
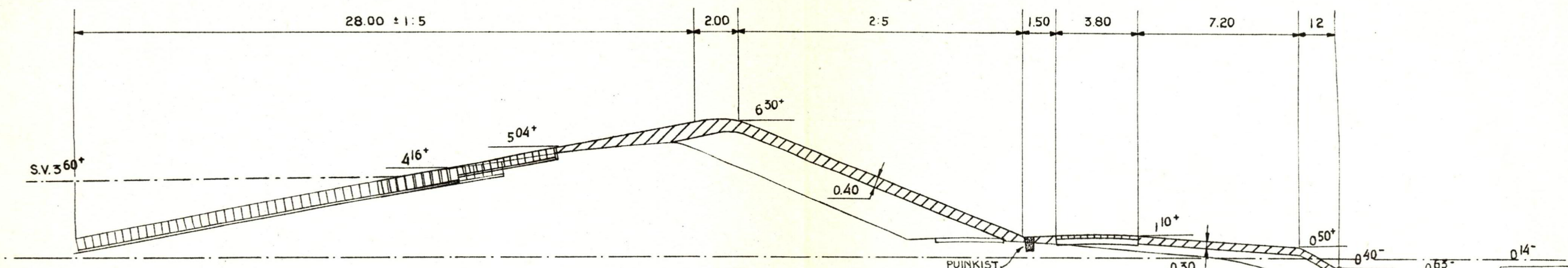

PROF. 6

VERHOOGING FRIESCHE ZEEDUKEN ZUIDERZEEWERKEN 1930
GEDEELTE HARLINGEN-ROPTAZUL

PROF. 7

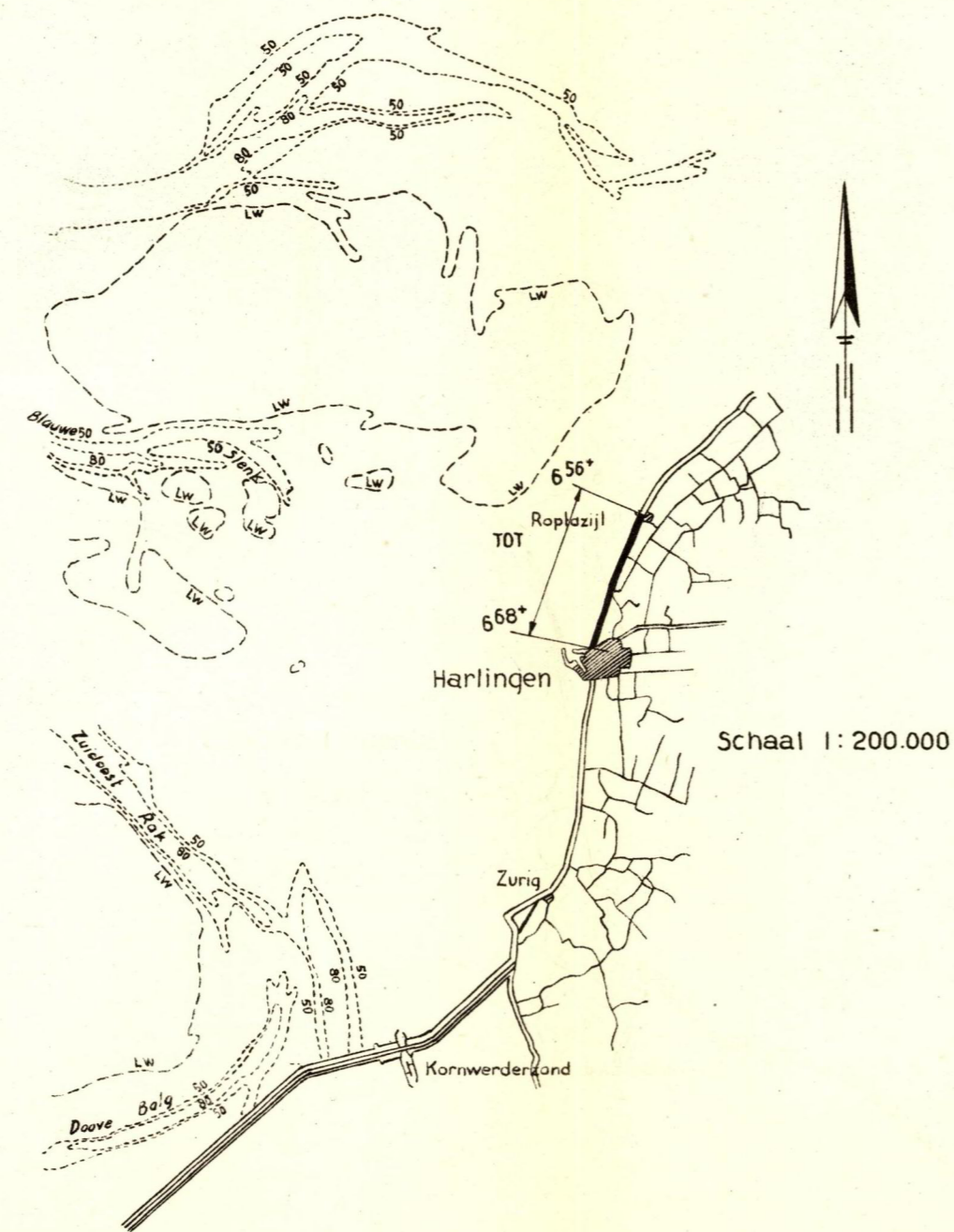
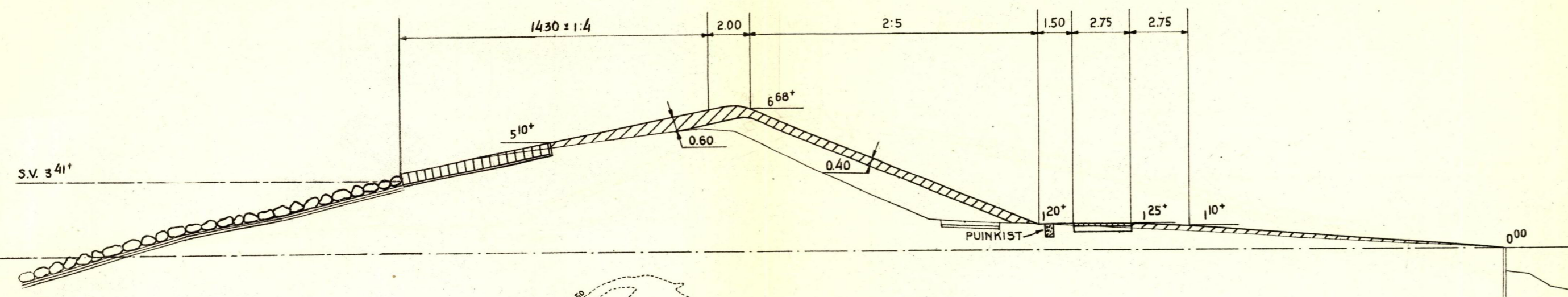

HONDSBOSSCHE ZEEWERING BESTAANDE DIJK 1872-1875

PROF. 8

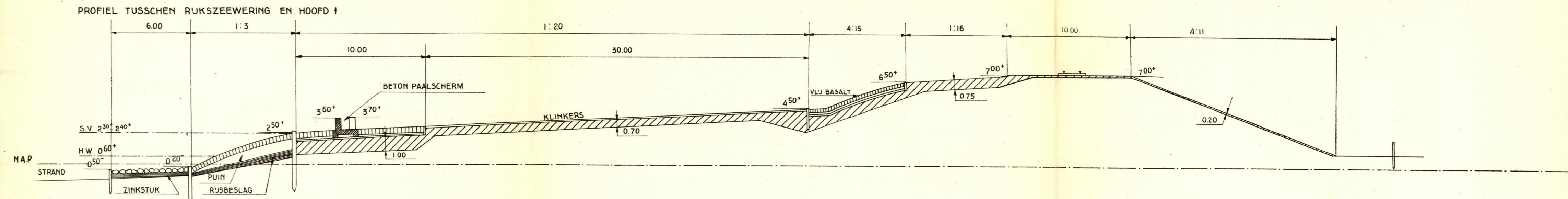

PROF. 9

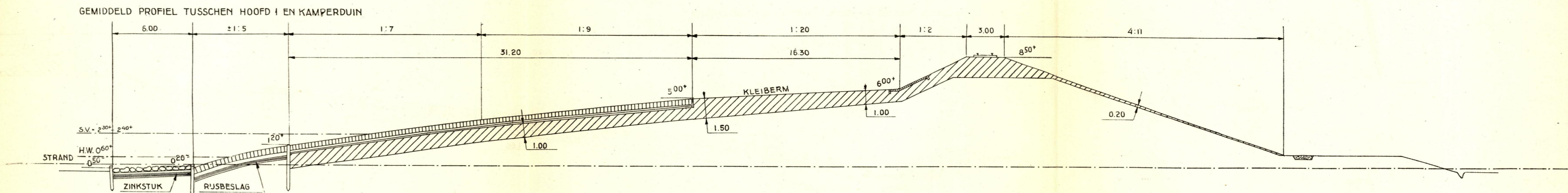

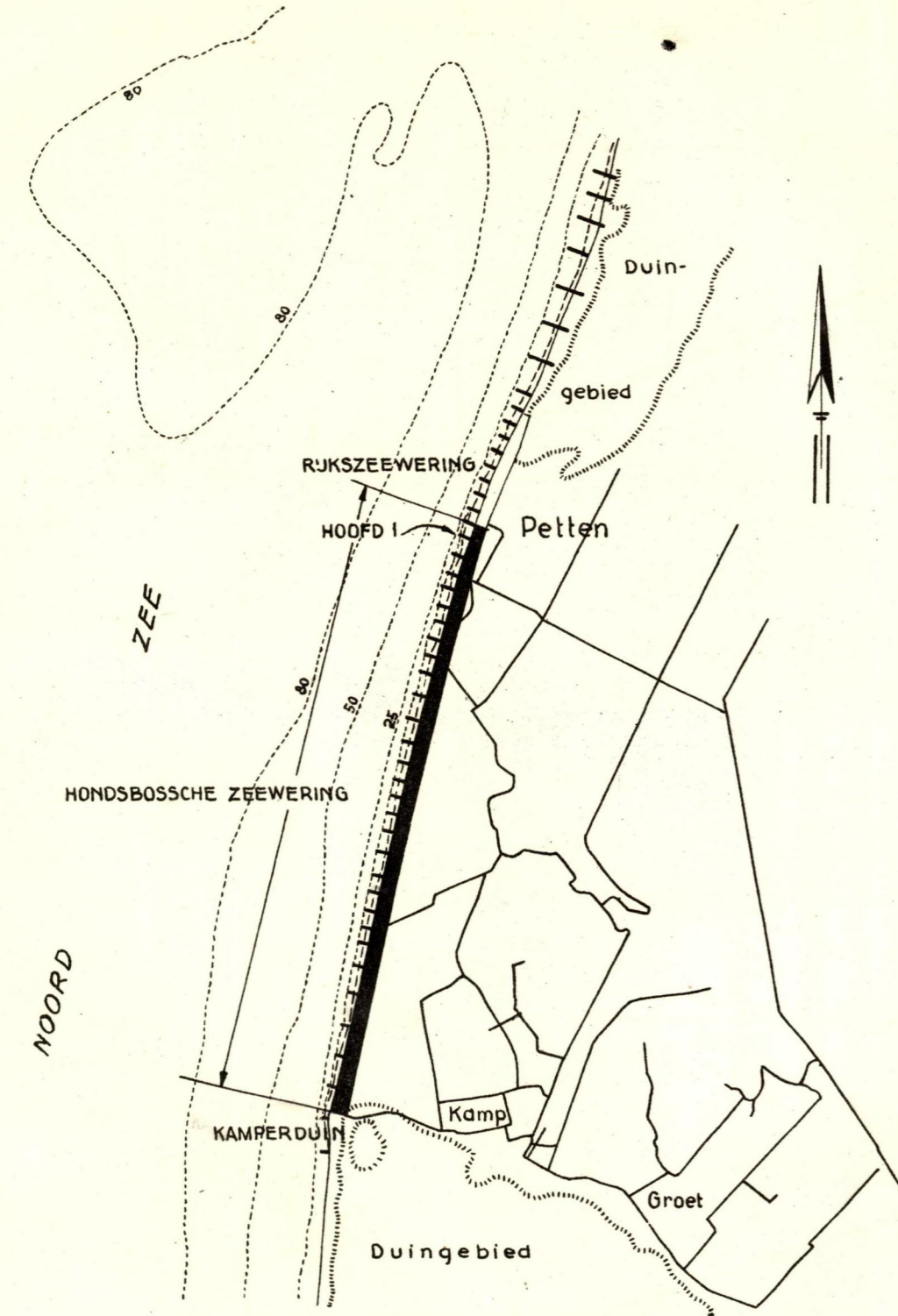

Schaal 1:50.000

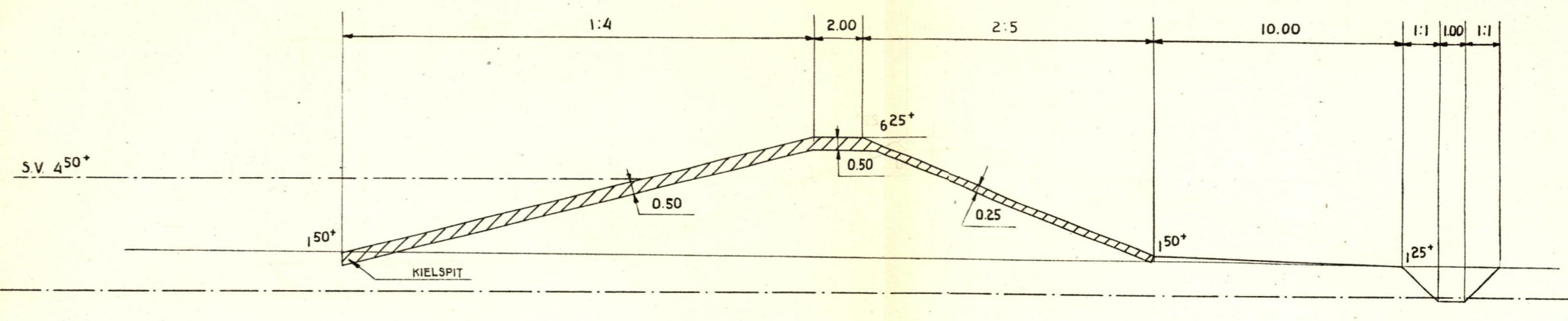
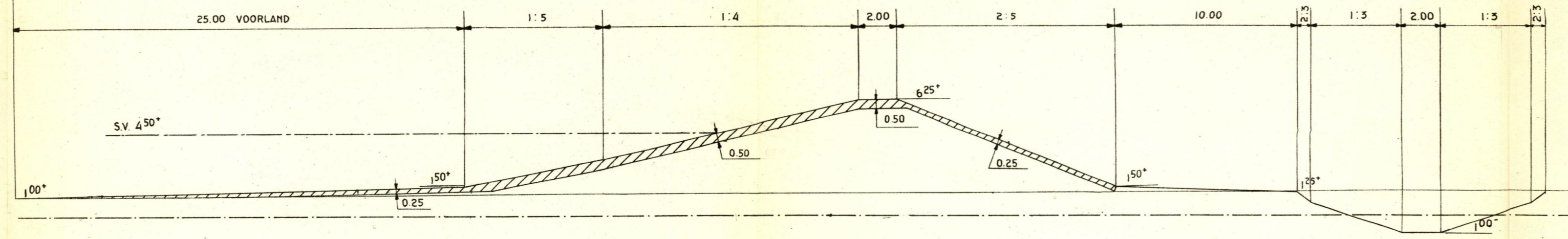

Schaal 1:50.000

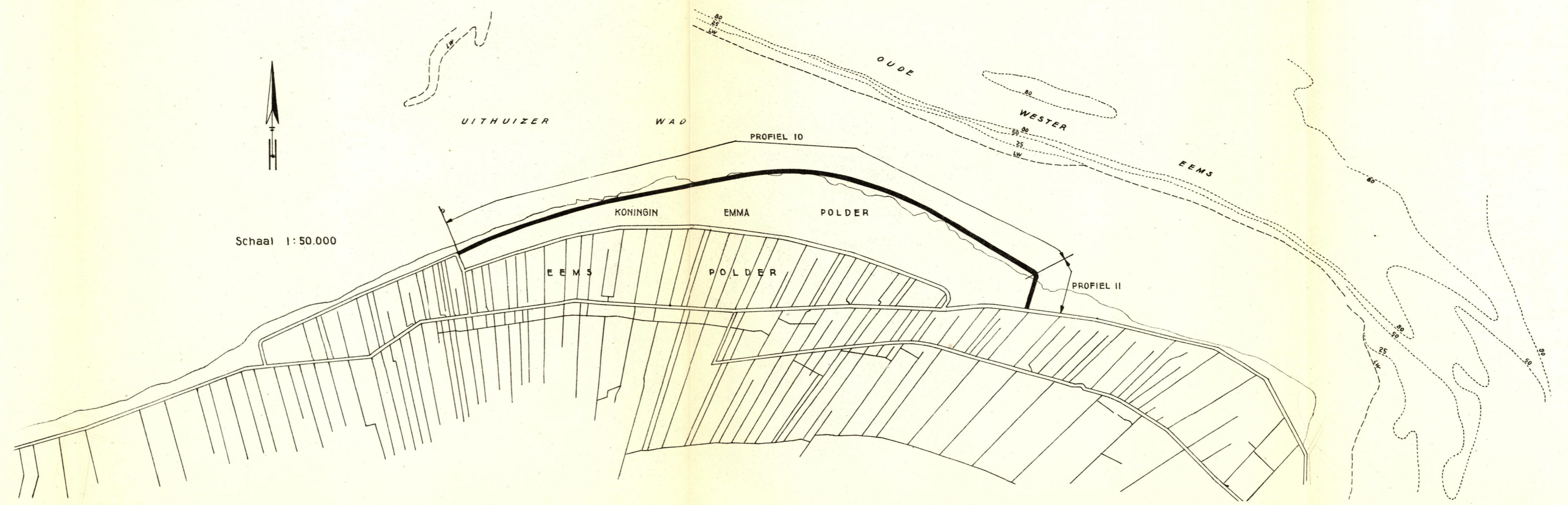

DJK VAN DEN MARIAPOLDER OP NOORD-BEVELAND BESTAANDE DJK 1719

PROF. 12

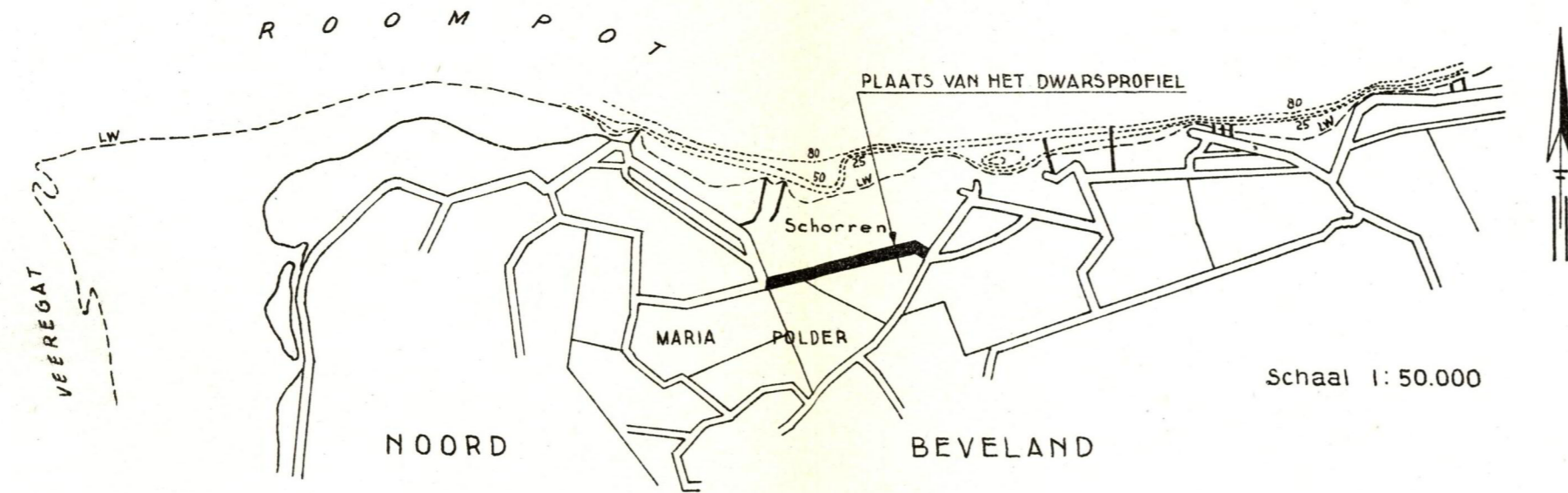
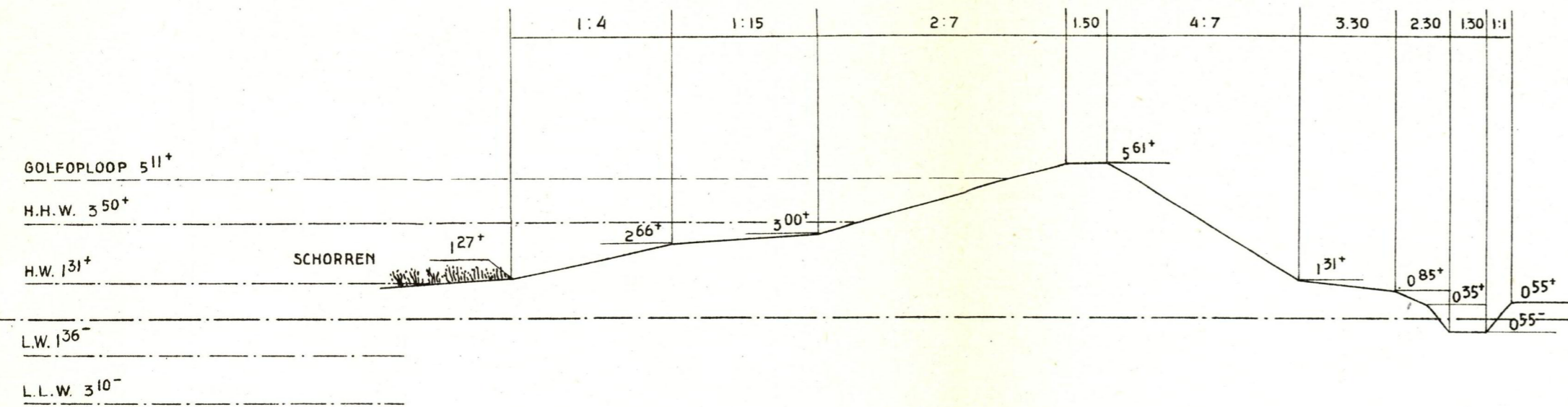

DJK VAN DEN CAL. VLIETEPOLDER OP NOORD-BEVELAND BESTAANDE DJK 1687

PROF. 13

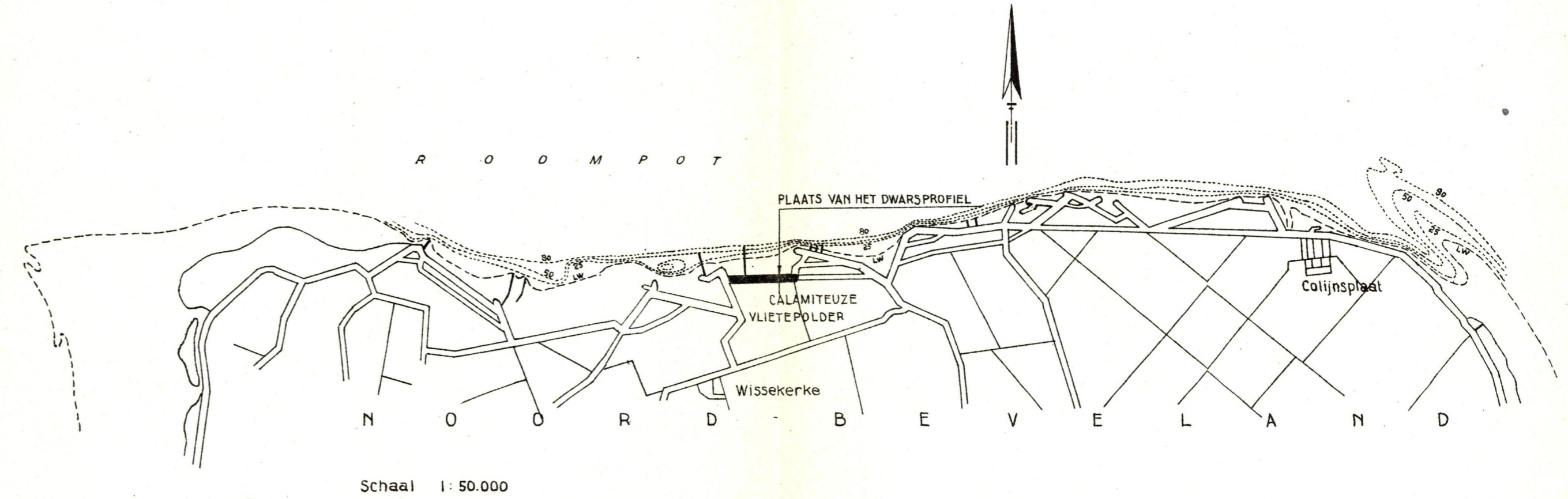
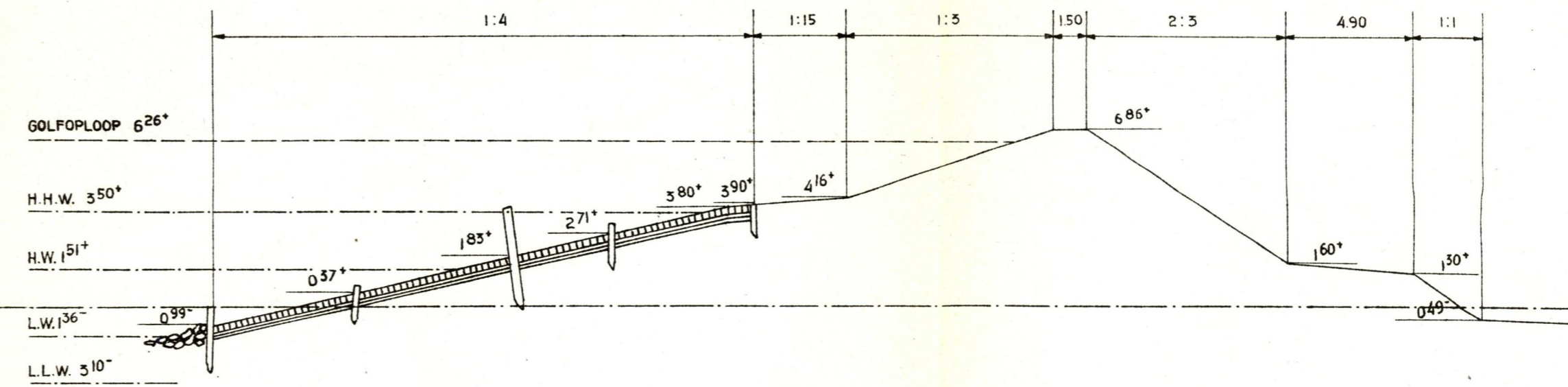

DJK VAN HET WATERSCHAP HOEDEKENSKERKE OP ZUID-BEVELAND BESTAANDE DJK

PROF. 14

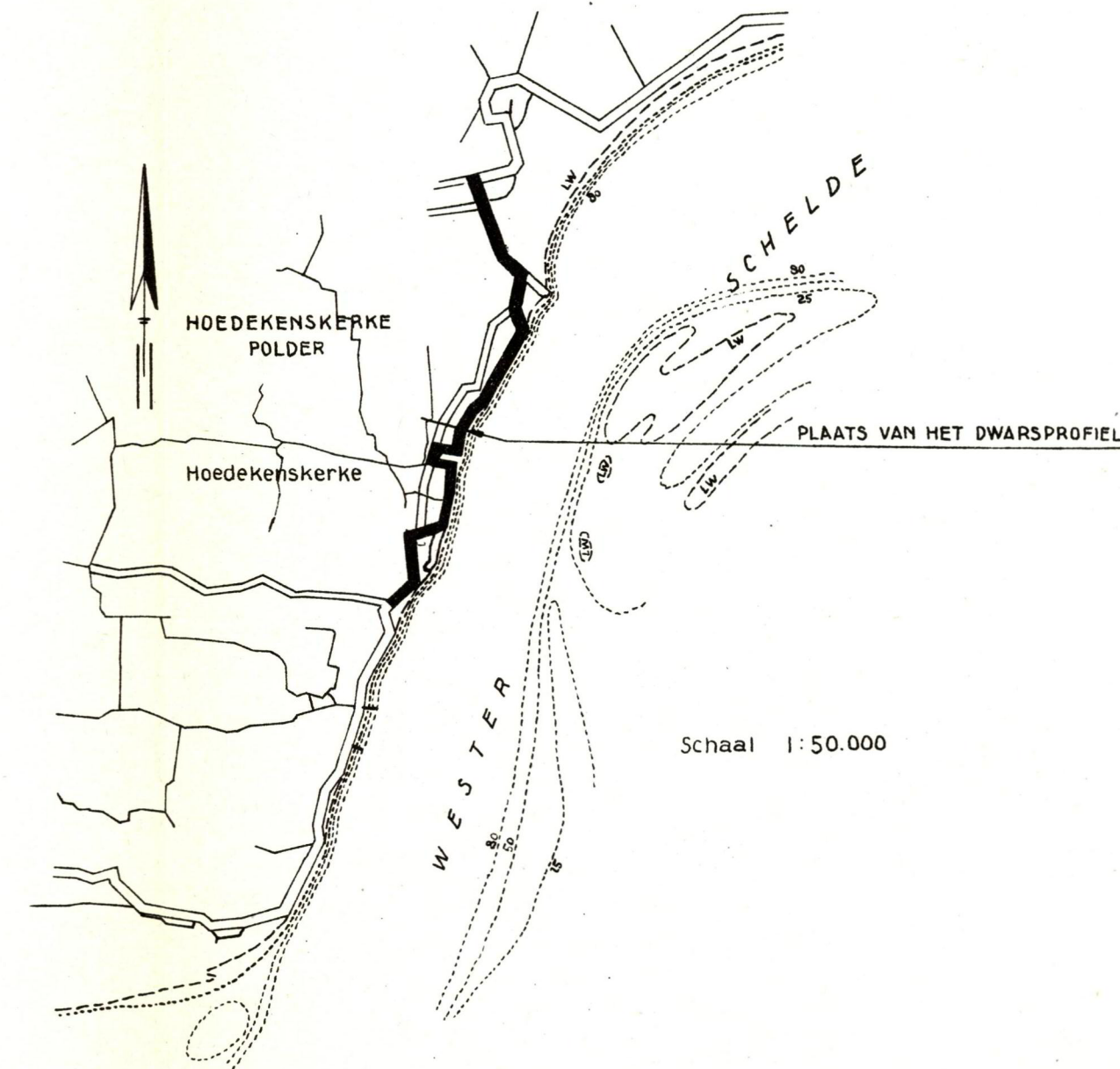
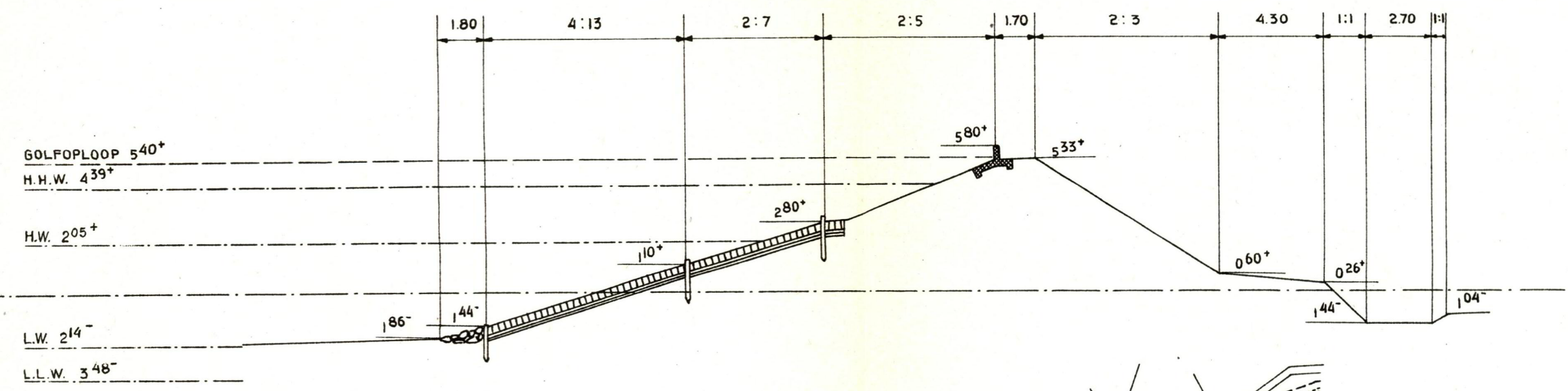

DJK VANDEN CAL. BORSSELEPOLDER OP ZUID-BEVELAND BESTAANDE DJK 1616

PROF. 15

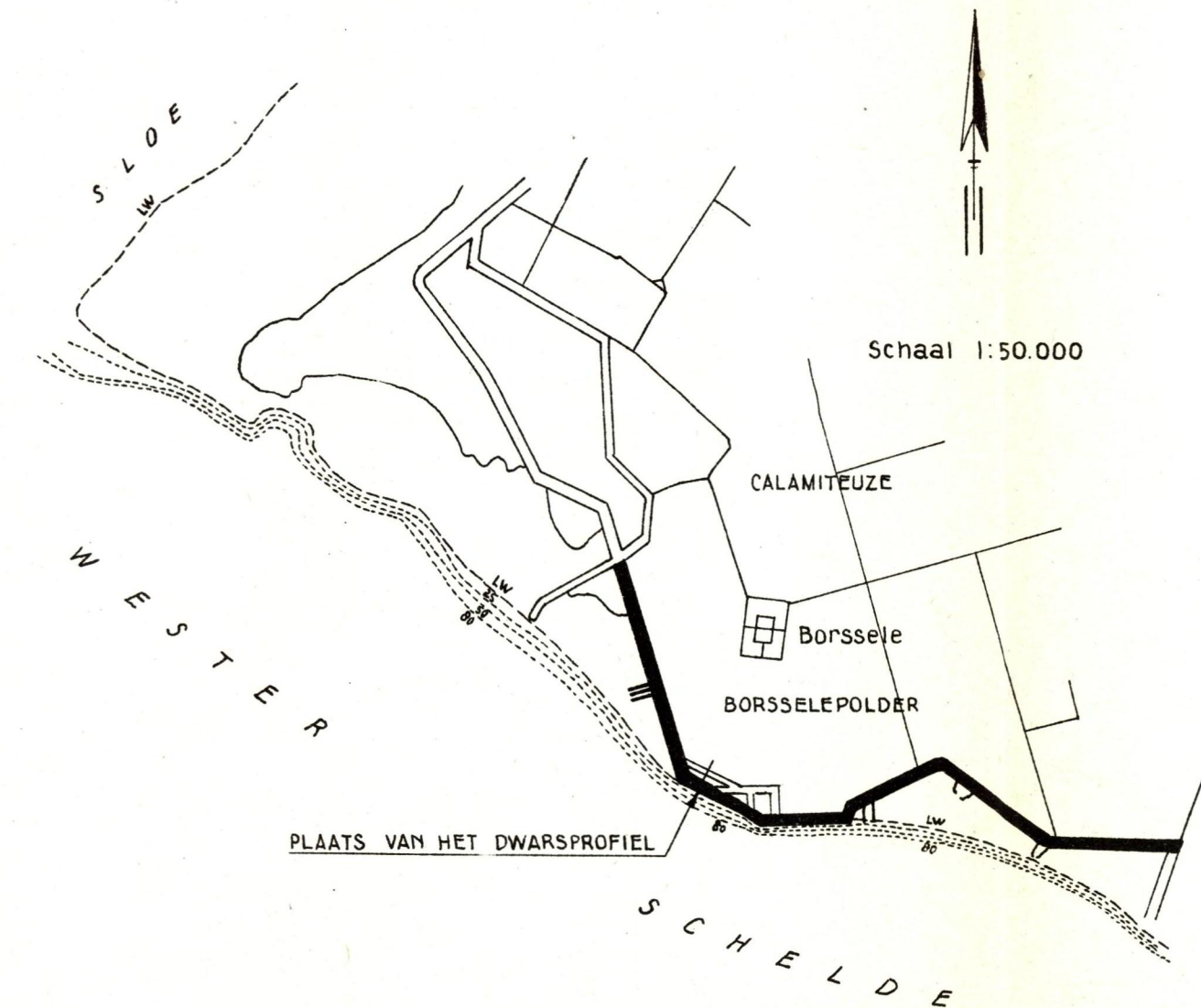
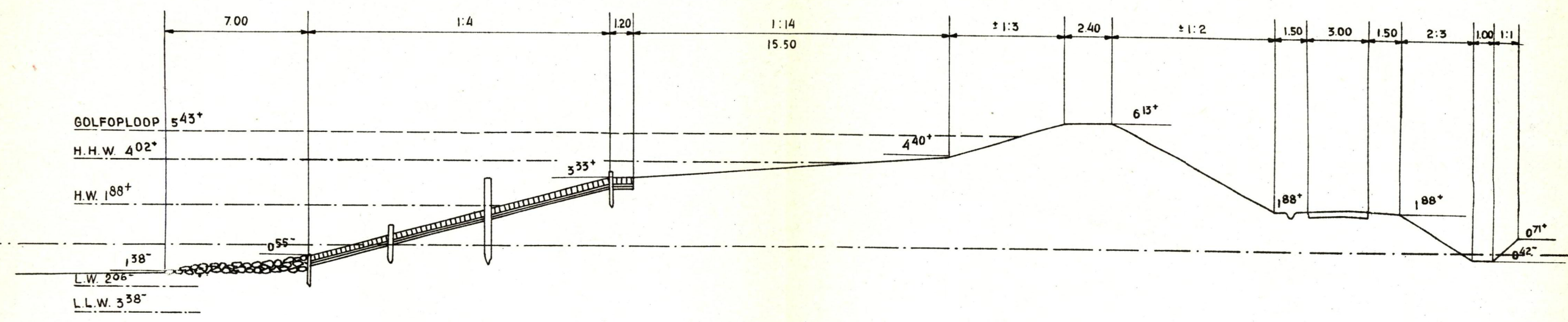

DJUK VAN DEN DIJCKMEESTERPOLDER TECHNISCH BUREAU DER DOMEINEN 1918

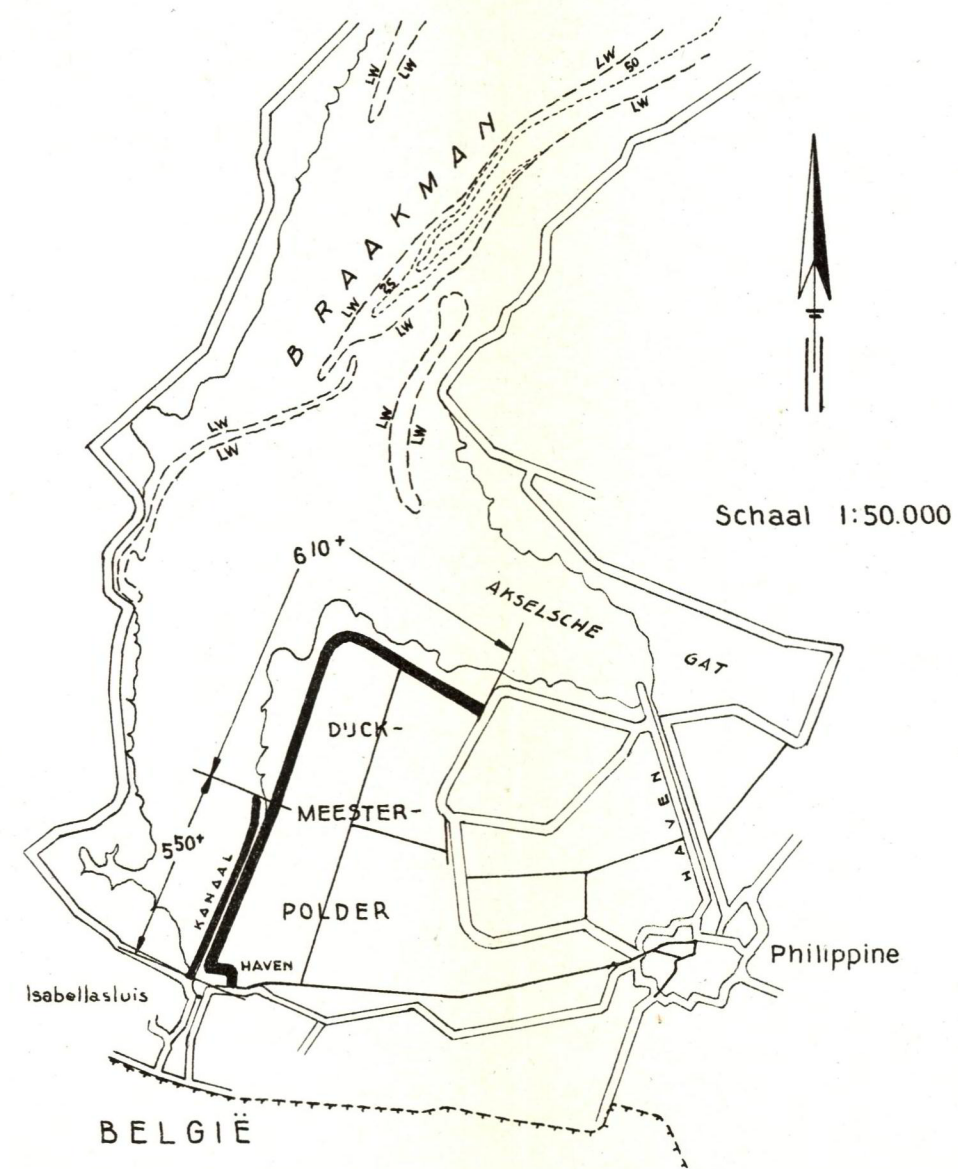
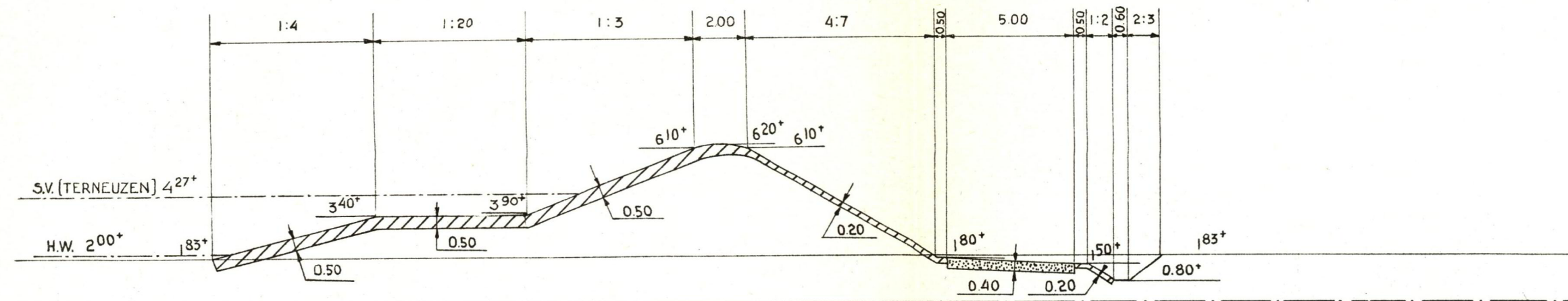

DJUK VAN DEN HELLEGATPOLDER TECHNISCH BUREAU DER DOMEINEN 1925

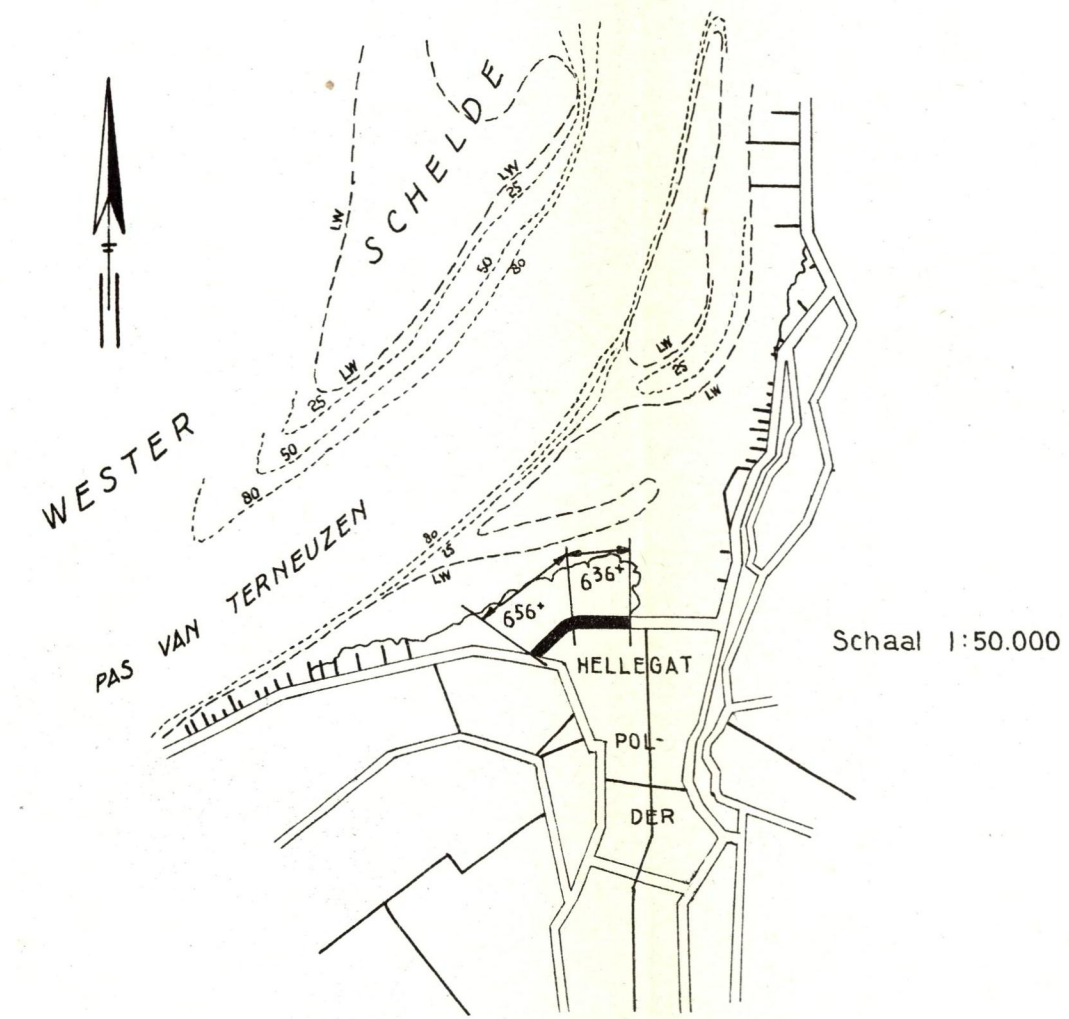
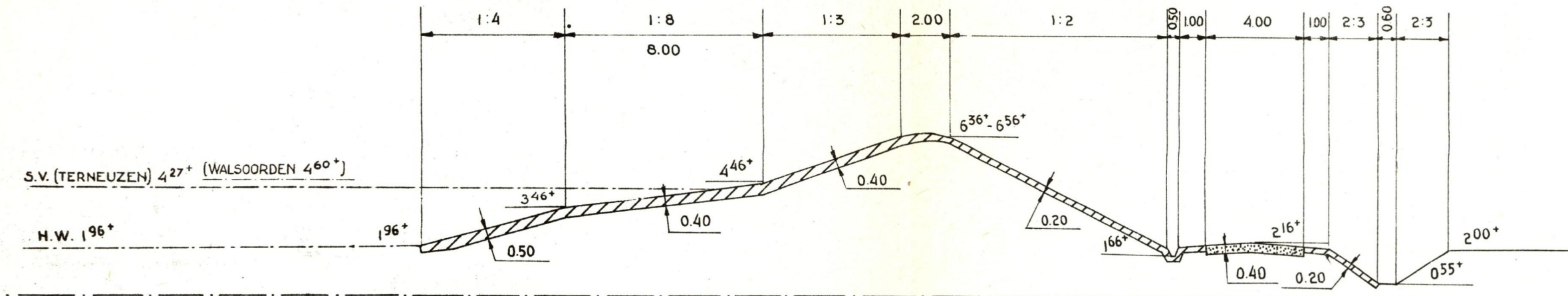

DJK VAN DEN HELLEGATPOLDER TECHNISCH BUREAU DER DOMEINEN 1925

PROF. 18

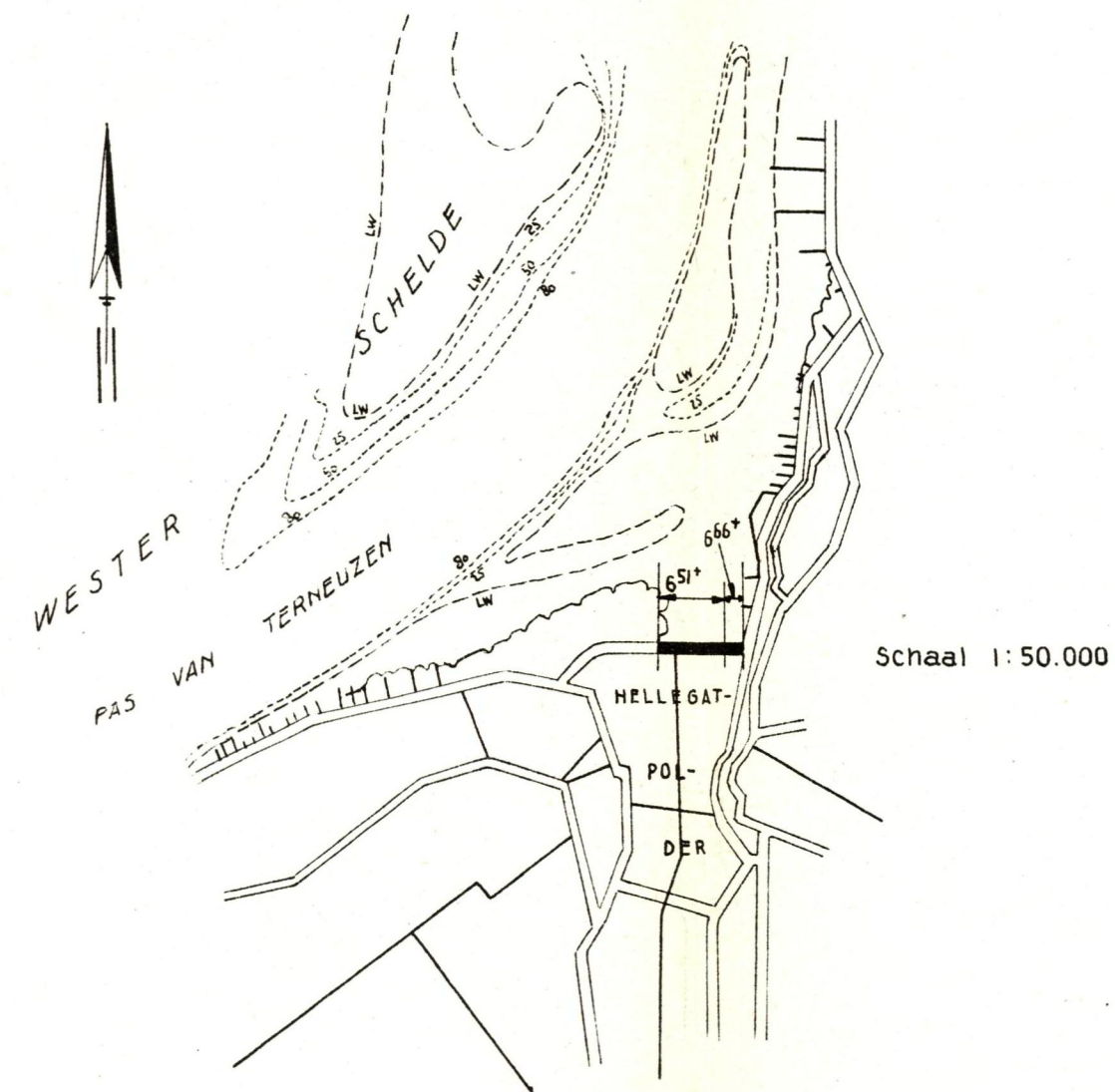
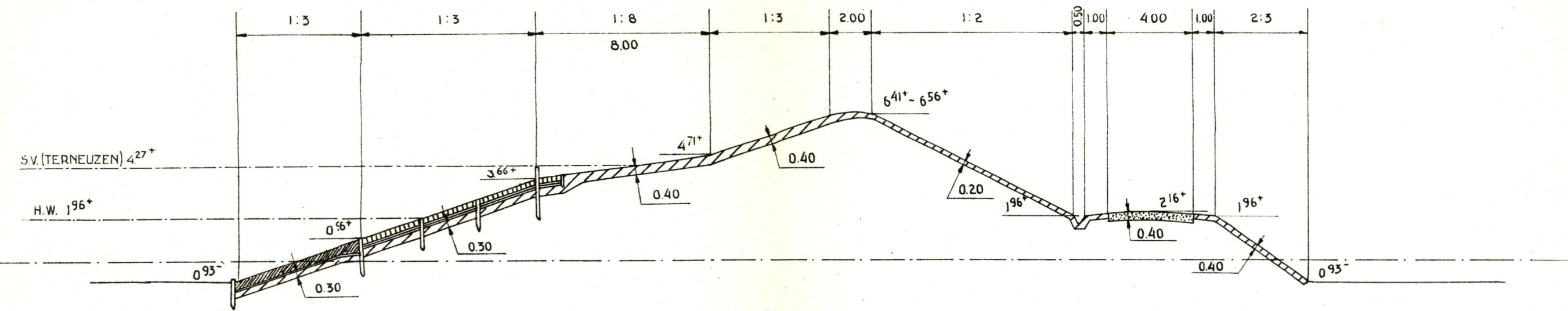

DJK VAN DEN ZUIDHOLLANDSCHE BIESBOSCH TECHNISCH BUREAU DER DOMEINEN 1926

PROF. 19

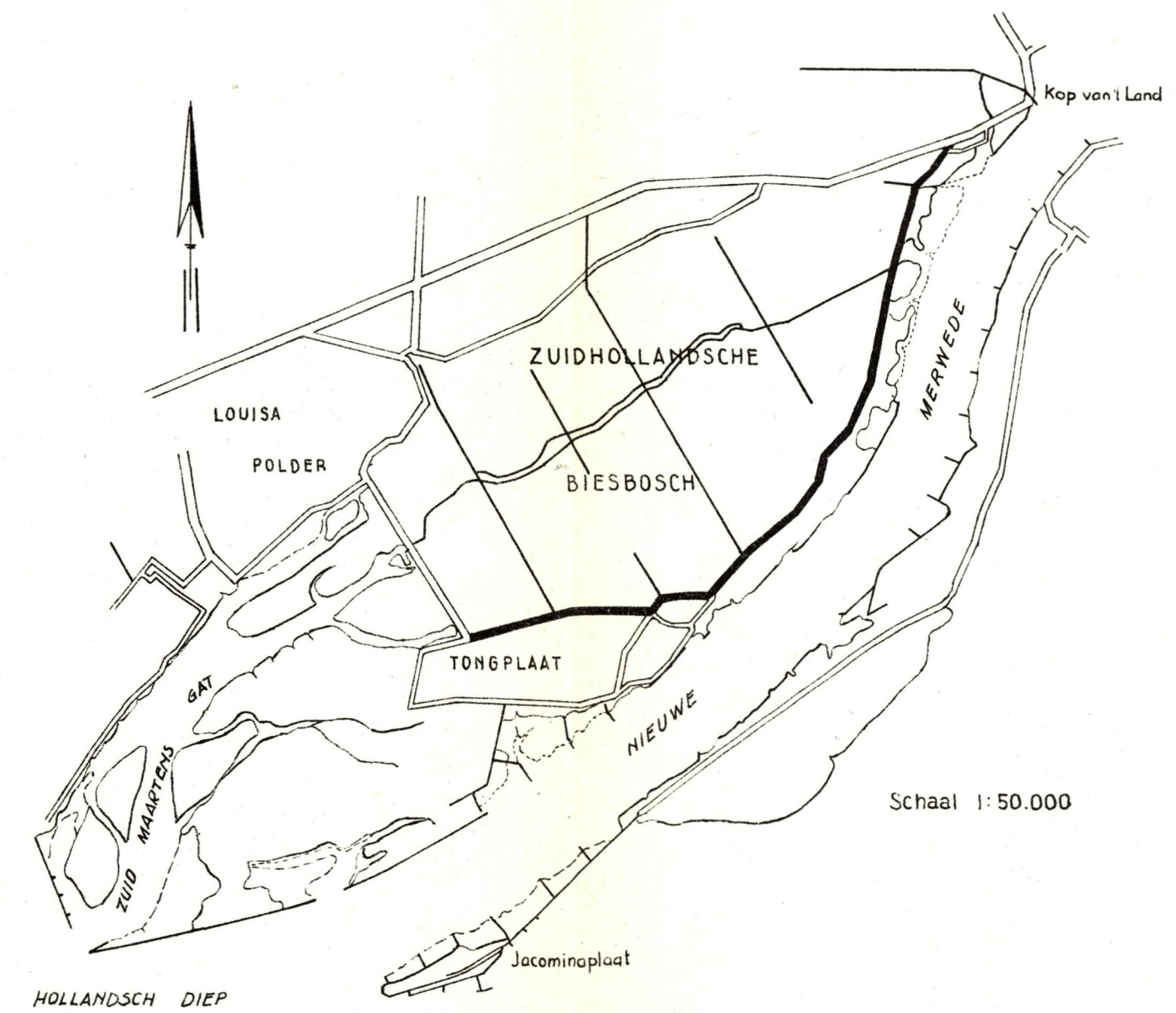
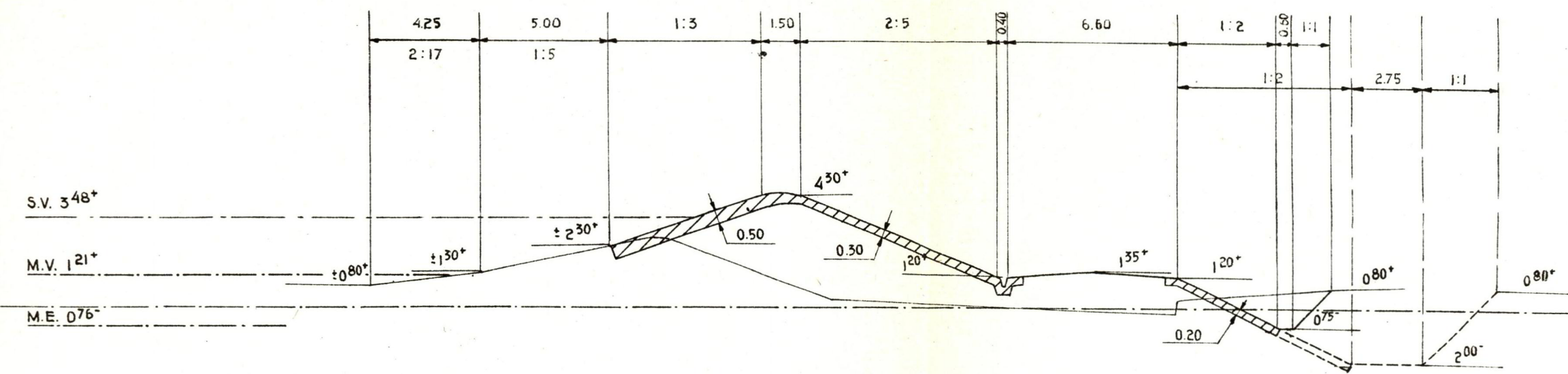

DIJK VAN DEN ZUIDHOLLANDSCHE BIESBOSCH

TECHNISCH BUREAU DER DOMEINEN 1926

PROF. 20

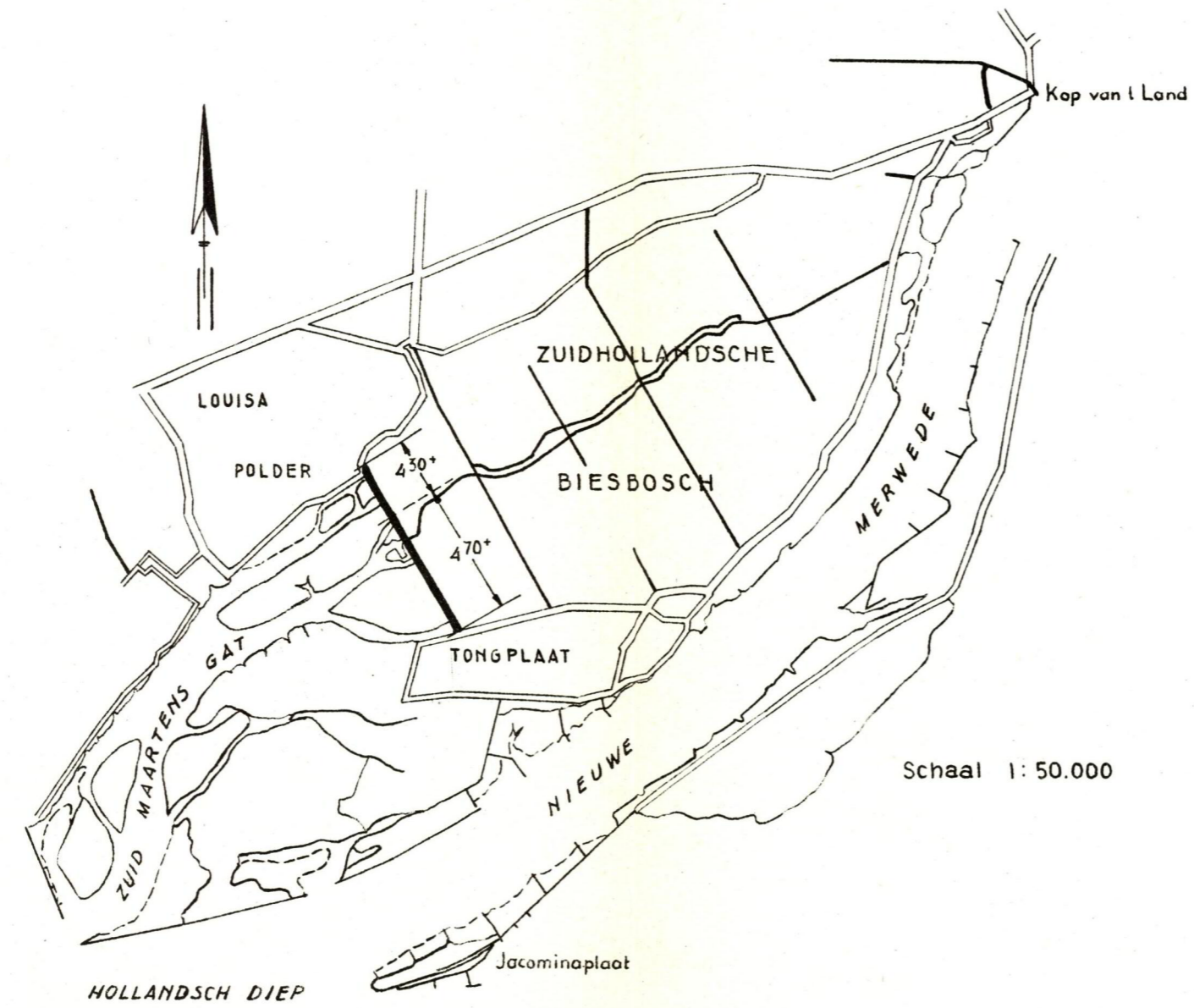
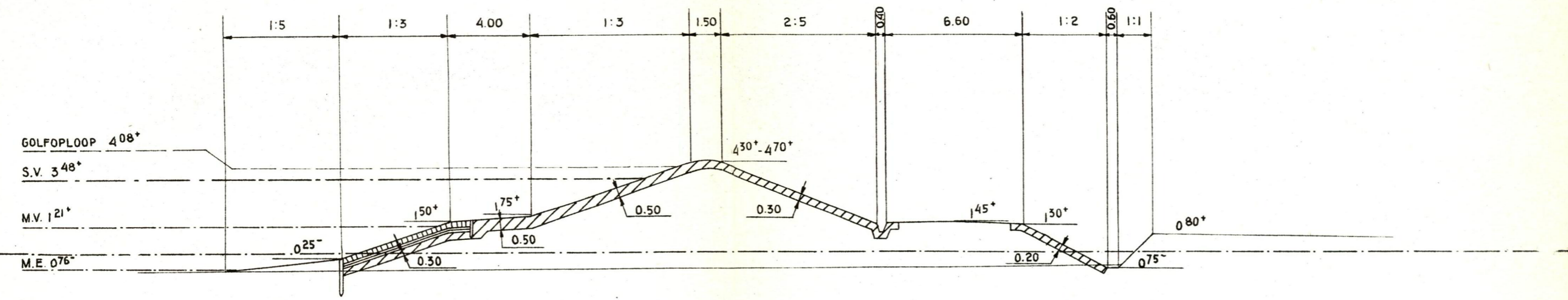

DIJK VAN DEN HOGERWAARDPOLDER

TECHNISCH BUREAU DER DOMEINEN 1914

BESCHADIGING TEN GEVOLGE VANDEN STORMVLOED VAN 25 OP 26 NOVEMBER 1928
EN DE DAARNA UITGEVOERDE DIJKSVERBETERING.

PROF. 21

DWARSPROFIEL TUSSCHEN DE DIJKPALEN 14 EN 15. SCHAAL 1:100

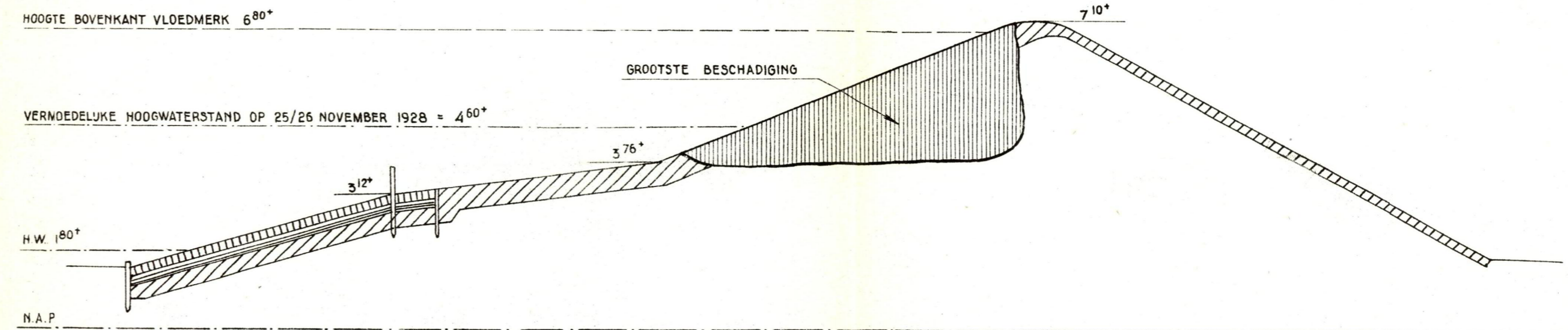

PROF. 22

DWARSPROFIEL BIJ DIJKPAAL 28. SCHAAL 1:100.

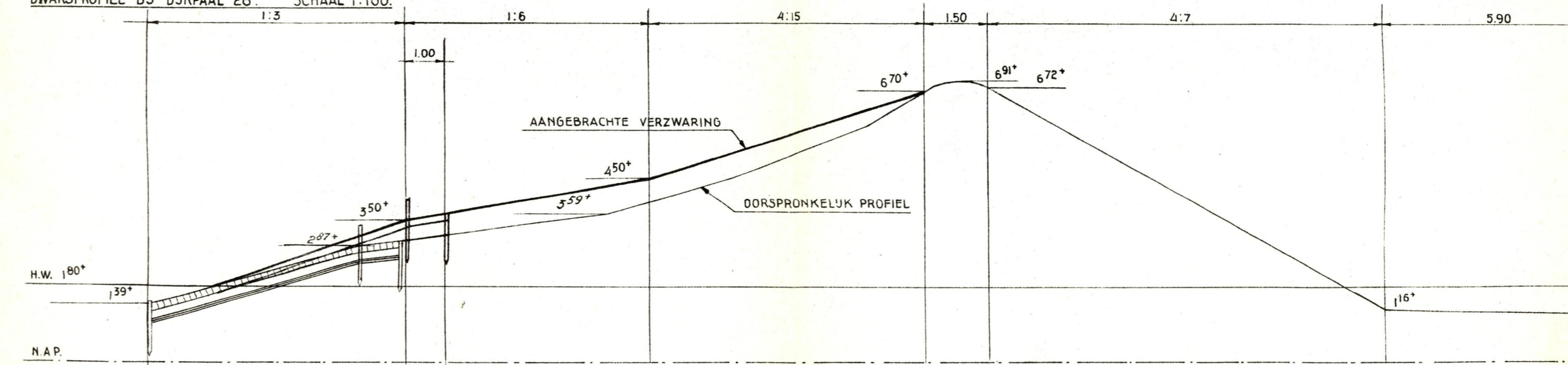

OOSTER

SCHELDE

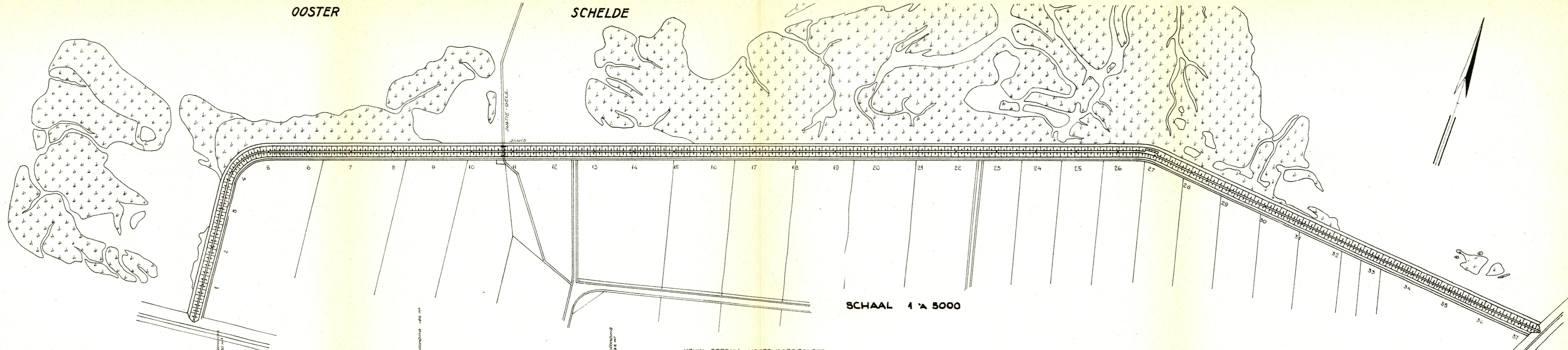

SCHAAL 1 : 5000

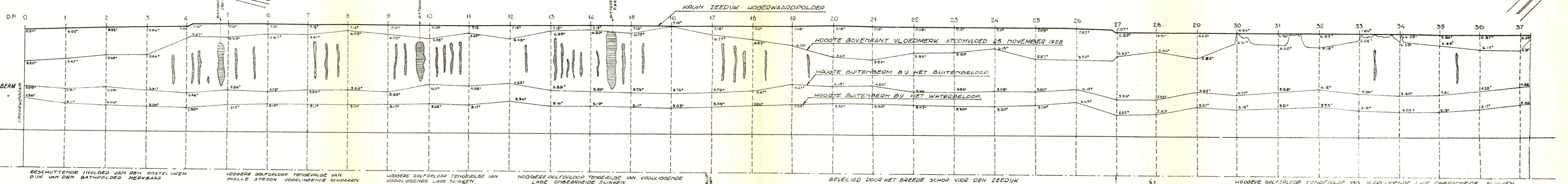

LENGTESCHAAL 1 : 5000
HOOGTESCHAAL 1 : 100

BESCHUTTENDE INVLOED VAN DEN OOSTELIJKEN DIJK VAN DEN BATHPOLDEER MERKBAAR

HOOGERE GOLFPLOEP TENGEVOLGE VAN SMALLE STROOK VOORLIGGENDE SCHORREN

HOOGERE GOLFPLOEP TENGEVOLGE VAN VOORLIGGENDE LAAG SLIKKEN

HOOGERE GOLFPLOEP TENGEVOLGE VAN VOORLIGGENDE LAAG ONBEGROEIDE SLIKKEN

BEVEILIGD DOOR HET BREED SCHOR VOOR DEN ZEEDIJK

HOOGERE GOLFPLOEP TENGEVOLGE VAN VOORLIGGENDE LAAG ONBEGROEIDE SLIKKEN

BOVENKANT BUITENBERM
ONDERKANT

KRUIJN ZEEDIJK HOGERWAARDPOLDER

DP. 0 1 2 3 4 5 6 7 8 9 10 11 12 13 14 15 16 17 18 19 20 21 22 23 24 25 26 27 28 29 30 31 32 33 34 35 36 37

6.80° 6.92° 6.94° 7.00° 7.12° 7.12° 7.13° 7.12° 7.10° 7.10° 7.12° 7.13° 7.15° 7.15° 7.10° 7.10° 7.12° 7.11° 7.08° 7.10° 7.12° 7.08° 7.12° 7.11° 7.09° 7.07° 7.07° 6.80° 6.21° 6.22° 6.41° 6.60° 6.65° 6.56° 6.08° 6.86° 6.87° 6.87° 6.87°

5.80° 4.47° 3.60° 3.64° 3.66° 3.86° 3.72° 3.61° 3.67° 3.63° 4.11° 4.05° 4.22° 3.88° 3.92° 3.76° 3.76° 3.77° 4.21° 4.13° 4.20° 3.92° 3.99° 3.94° 4.10° 3.54° 3.50° 3.95° 3.77° 3.98° 4.12° 3.90° 3.60° 3.61° 4.25° 4.26°

5.80° 4.47° 3.60° 3.64° 3.66° 3.86° 3.72° 3.61° 3.67° 3.63° 4.11° 4.05° 4.22° 3.88° 3.92° 3.76° 3.76° 3.77° 4.21° 4.13° 4.20° 3.92° 3.99° 3.94° 4.10° 3.54° 3.50° 3.95° 3.77° 3.98° 4.12° 3.90° 3.60° 3.61° 4.25° 4.26°

5.80° 4.47° 3.60° 3.64° 3.66° 3.86° 3.72° 3.61° 3.67° 3.63° 4.11° 4.05° 4.22° 3.88° 3.92° 3.76° 3.76° 3.77° 4.21° 4.13° 4.20° 3.92° 3.99° 3.94° 4.10° 3.54° 3.50° 3.95° 3.77° 3.98° 4.12° 3.90° 3.60° 3.61° 4.25° 4.26°

5.80° 4.47° 3.60° 3.64° 3.66° 3.86° 3.72° 3.61° 3.67° 3.63° 4.11° 4.05° 4.22° 3.88° 3.92° 3.76° 3.76° 3.77° 4.21° 4.13° 4.20° 3.92° 3.99° 3.94° 4.10° 3.54° 3.50° 3.95° 3.77° 3.98° 4.12° 3.90° 3.60° 3.61° 4.25° 4.26°

5.80° 4.47° 3.60° 3.64° 3.66° 3.86° 3.72° 3.61° 3.67° 3.63° 4.11° 4.05° 4.22° 3.88° 3.92° 3.76° 3.76° 3.77° 4.21° 4.13° 4.20° 3.92° 3.99° 3.94° 4.10° 3.54° 3.50° 3.95° 3.77° 3.98° 4.12° 3.90° 3.60° 3.61° 4.25° 4.26°

5.80° 4.47° 3.60° 3.64° 3.66° 3.86° 3.72° 3.61° 3.67° 3.63° 4.11° 4.05° 4.22° 3.88° 3.92° 3.76° 3.76° 3.77° 4.21° 4.13° 4.20° 3.92° 3.99° 3.94° 4.10° 3.54° 3.50° 3.95° 3.77° 3.98° 4.12° 3.90° 3.60° 3.61° 4.25° 4.26°

5.80° 4.47° 3.60° 3.64° 3.66° 3.86° 3.72° 3.61° 3.67° 3.63° 4.11° 4.05° 4.22° 3.88° 3.92° 3.76° 3.76° 3.77° 4.21° 4.13° 4.20° 3.92° 3.99° 3.94° 4.10° 3.54° 3.50° 3.95° 3.77° 3.98° 4.12° 3.90° 3.60° 3.61° 4.25° 4.26°

5.80° 4.47° 3.60° 3.64° 3.66° 3.86° 3.72° 3.61° 3.67° 3.63° 4.11° 4.05° 4.22° 3.88° 3.92° 3.76° 3.76° 3.77° 4.21° 4.13° 4.20° 3.92° 3.99° 3.94° 4.10° 3.54° 3.50° 3.95° 3.77° 3.98° 4.12° 3.90° 3.60° 3.61° 4.25° 4.26°

5.80° 4.47° 3.60° 3.64° 3.66° 3.86° 3.72° 3.61° 3.67° 3.63° 4.11° 4.05° 4.22° 3.88° 3.92° 3.76° 3.76° 3.77° 4.21° 4.13° 4.20° 3.92° 3.99° 3.94° 4.10° 3.54° 3.50° 3.95° 3.77° 3.98° 4.12° 3.90° 3.60° 3.61° 4.25° 4.26°

5.80° 4.47° 3.60° 3.64° 3.66° 3.86° 3.72° 3.61° 3.67° 3.63° 4.11° 4.05° 4.22° 3.88° 3.92° 3.76° 3.76° 3.77° 4.21° 4.13° 4.20° 3.92° 3.99° 3.94° 4.10° 3.54° 3.50° 3.95° 3.77° 3.98° 4.12° 3.90° 3.60° 3.61° 4.25° 4.26°

5.80° 4.47° 3.60° 3.64° 3.66° 3.86° 3.72° 3.61° 3.67° 3.63° 4.11° 4.05° 4.22° 3.88° 3.92° 3.76° 3.76° 3.77° 4.21° 4.13° 4.20° 3.92° 3.99° 3.94° 4.10° 3.54° 3.50° 3.95° 3.77° 3.98° 4.12° 3.90° 3.60° 3.61° 4.25° 4.26°

5.80° 4.47° 3.60° 3.64° 3.66° 3.86° 3.72° 3.61° 3.67° 3.63° 4.11° 4.05° 4.22° 3.88° 3.92° 3.76° 3.76° 3.77° 4.21° 4.13° 4.20° 3.92° 3.99° 3.94° 4.10° 3.54° 3.50° 3.95° 3.77° 3.98° 4.12° 3.90° 3.60° 3.61° 4.25° 4.26°

5.80° 4.47° 3.60° 3.64° 3.66° 3.86° 3.72° 3.61° 3.67° 3.63° 4.11° 4.05° 4.22° 3.88° 3.92° 3.76° 3.76° 3.77° 4.21° 4.13° 4.20° 3.92° 3.99° 3.94° 4.10° 3.54° 3.50° 3.95° 3.77° 3.98° 4.12° 3.90° 3.60° 3.61° 4.25° 4.26°

5.80° 4.47° 3.60° 3.64° 3.66° 3.86° 3.72° 3.61° 3.67° 3.63° 4.11° 4.05° 4.22° 3.88° 3.92° 3.76° 3.76° 3.77° 4.21° 4.13° 4.20° 3.92° 3.99° 3.94° 4.10° 3.54° 3.50° 3.95° 3.77° 3.98° 4.12° 3.90° 3.60° 3.61° 4.25° 4.26°

5.80° 4.47° 3.60° 3.64° 3.66° 3.86° 3.72° 3.61° 3.67° 3.63° 4.11° 4.05° 4.22° 3.88° 3.92° 3.76° 3.76° 3.77° 4.21° 4.13° 4.20° 3.92° 3.99° 3.94° 4.10° 3.54° 3.50° 3.95° 3.77° 3.98° 4.12° 3.90° 3.60° 3.61° 4.25° 4.26°

5.80° 4.47° 3.60° 3.64° 3.66° 3.86° 3.72° 3.61° 3.67° 3.63° 4.11° 4.05° 4.22° 3.88° 3.92° 3.76° 3.76° 3.77° 4.21° 4.13° 4.20° 3.92° 3.99° 3.94° 4.10° 3.54° 3.50° 3.95° 3.77° 3.98° 4.12° 3.90° 3.60° 3.61° 4.25° 4.26°

D'JK VAN DEN OUDEN BOSPOLDER TECHNISCH BUREAU DER DOMEINEN 1939

ALGEMEEN DWARSPROFIEL

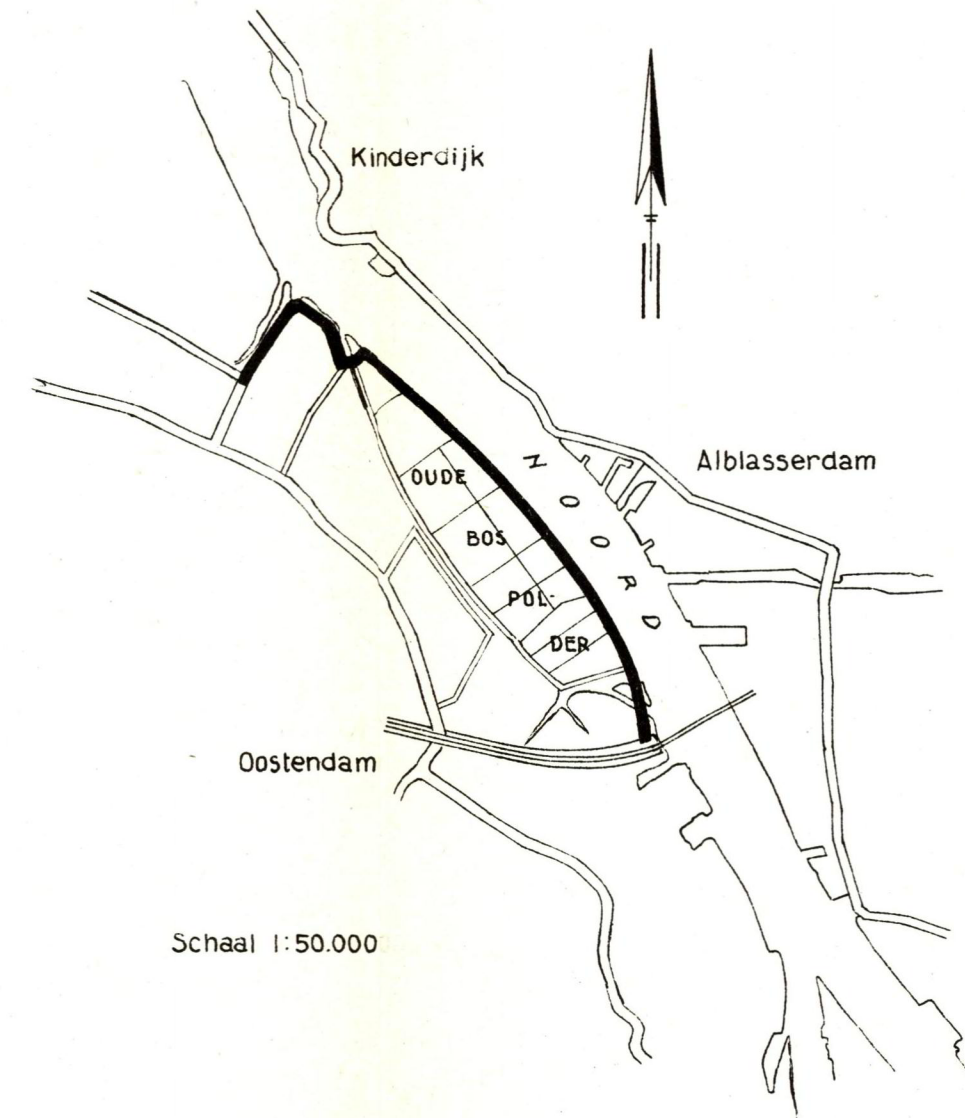
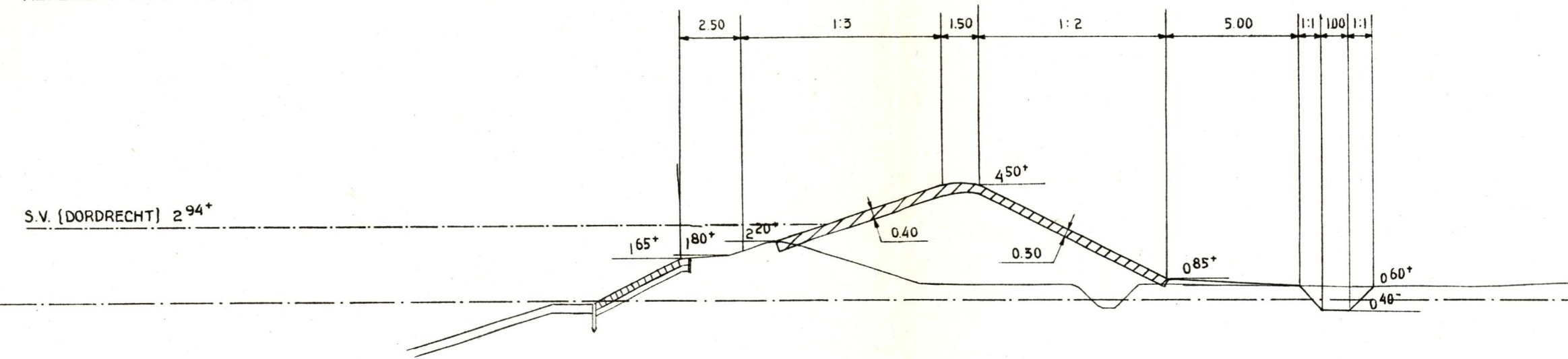

D'JK VAN DEN OUDEN BOSPOLDER TECHNISCH BUREAU DER DOMEINEN 1939

DWARSPROFIEL VOOR AFDAMMING GEULEN

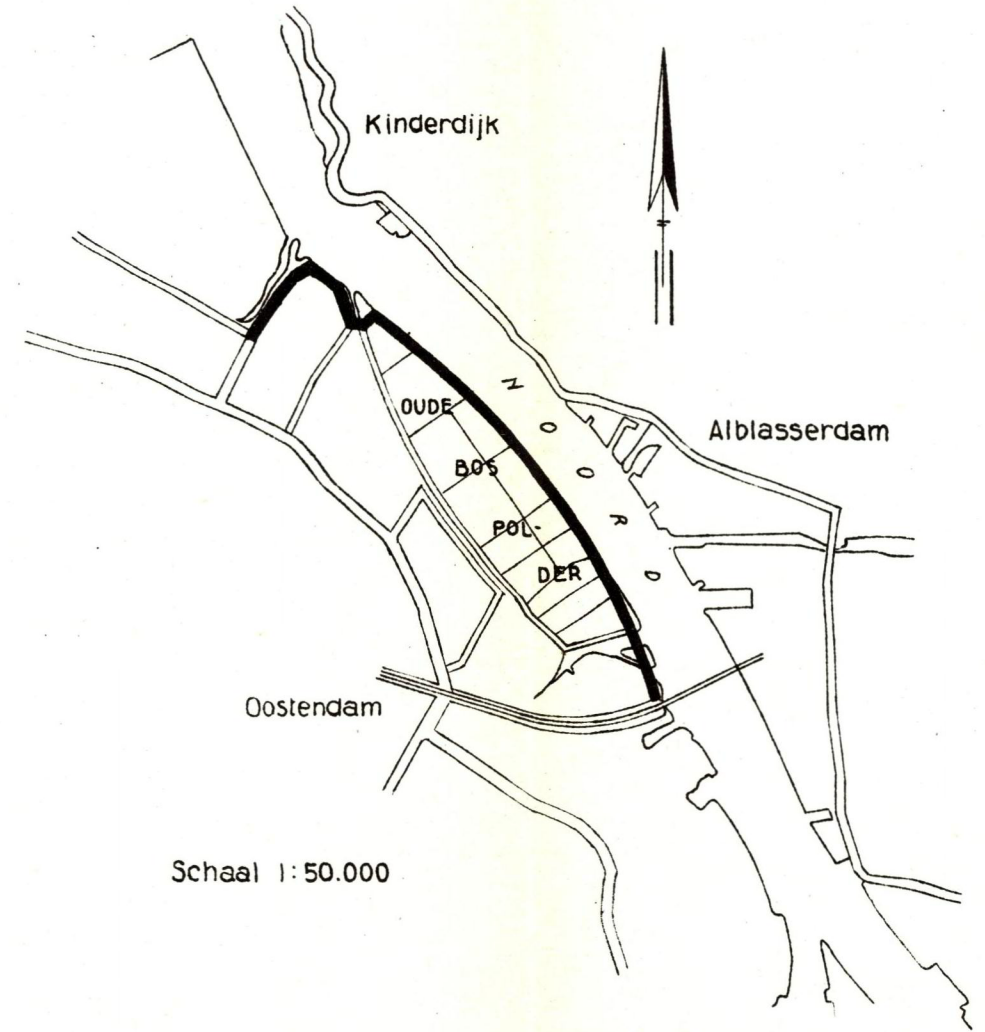
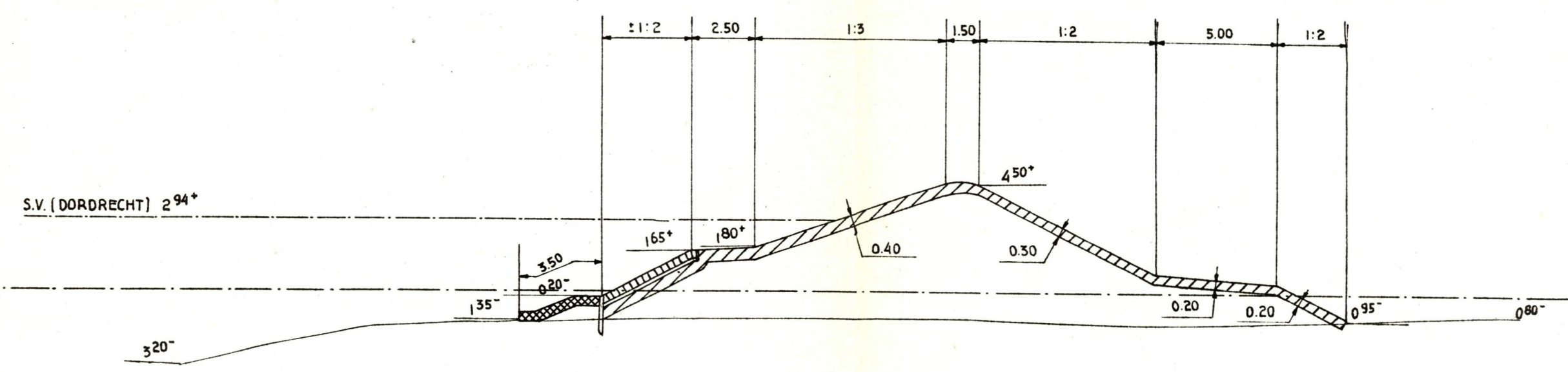

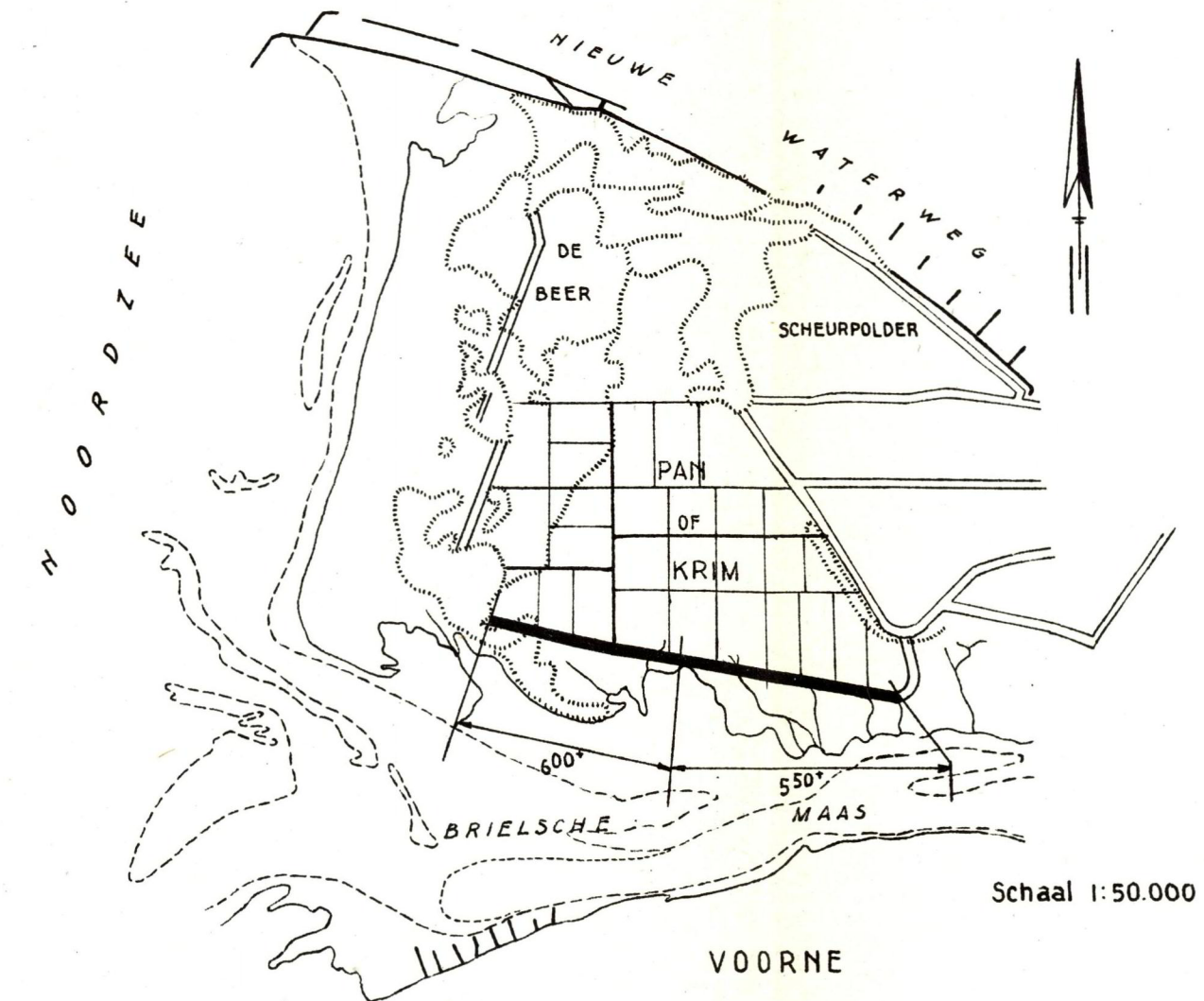
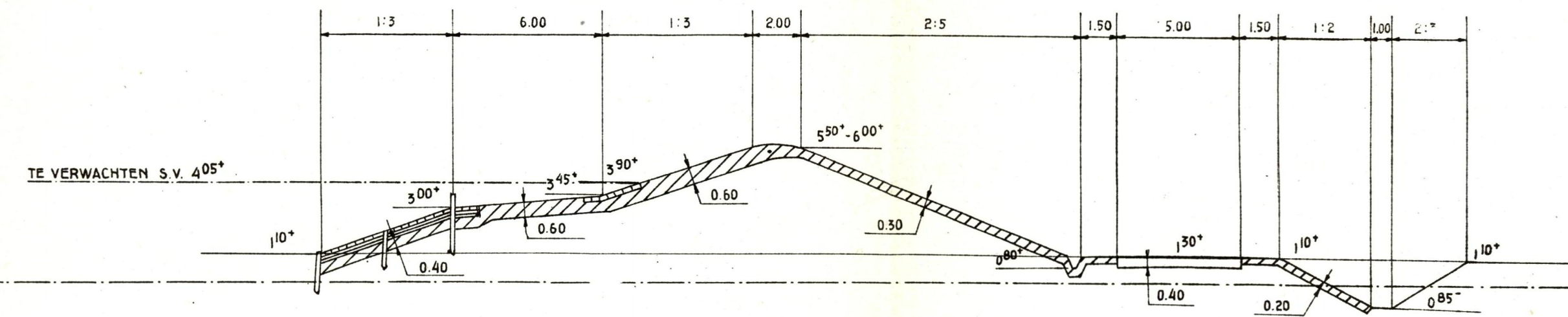
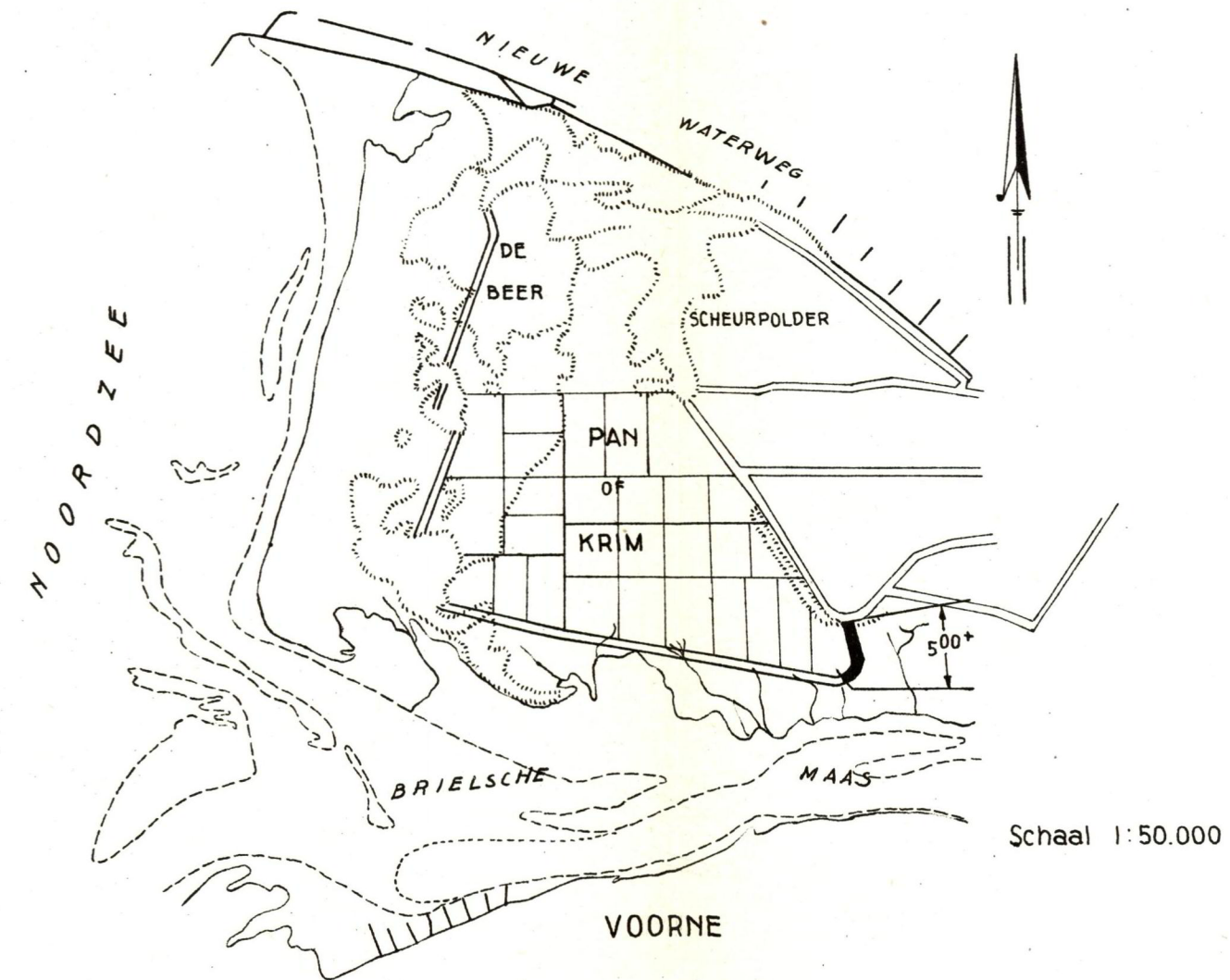
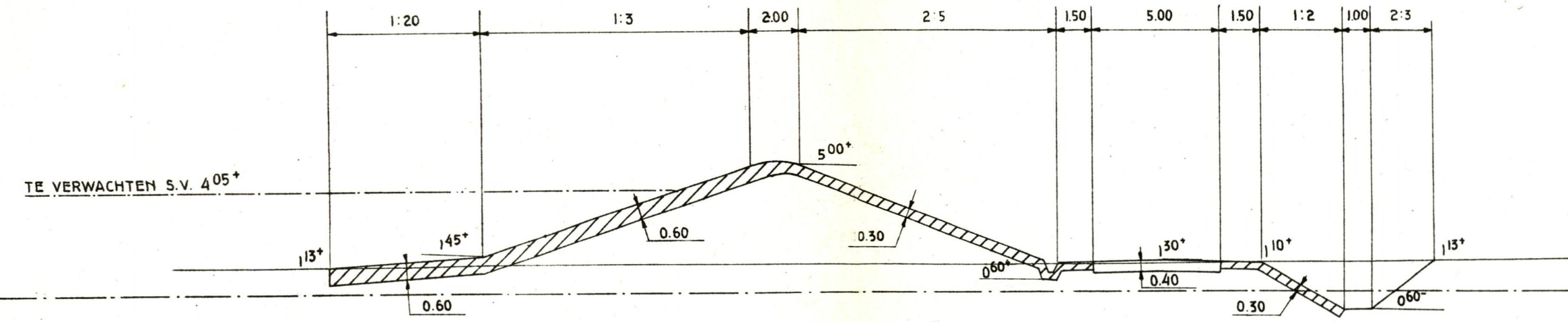

BEDIJNING PAN OF KRIM OP ROZENBURG

TECHNISCH BUREAU DER DOMEINEN 1943

PROF. 27

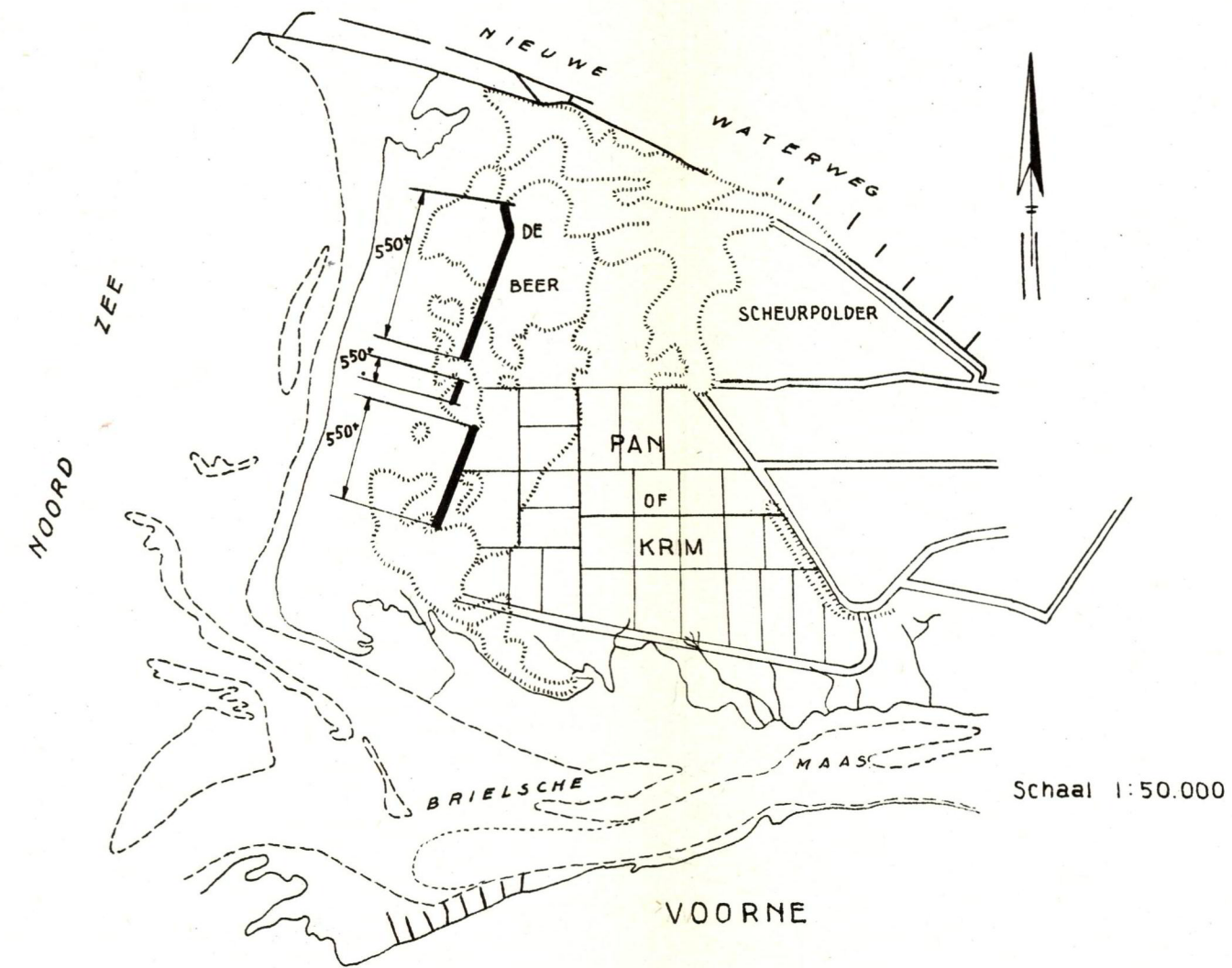
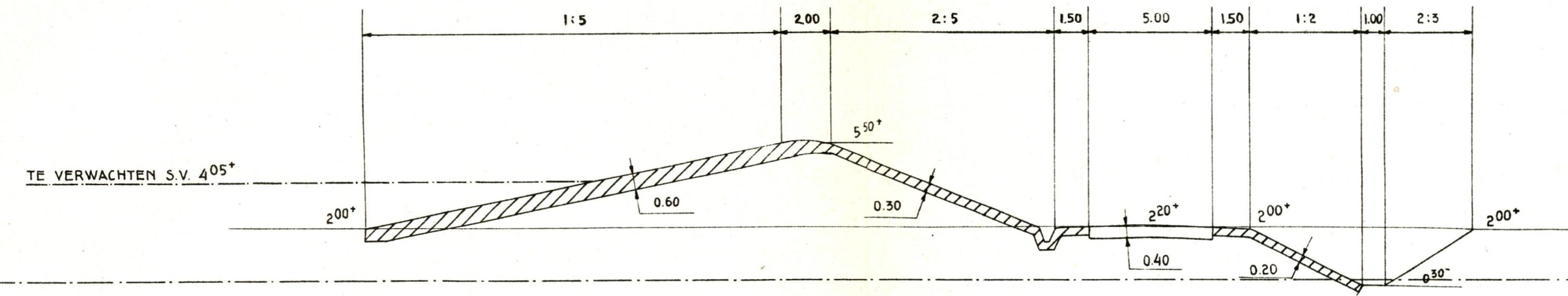

DIJKSVERHOOGING ZUIDZIJDE AMER - VEGETASPOLDER

RIJKSWATERSTAAT 1941

PROF. 28

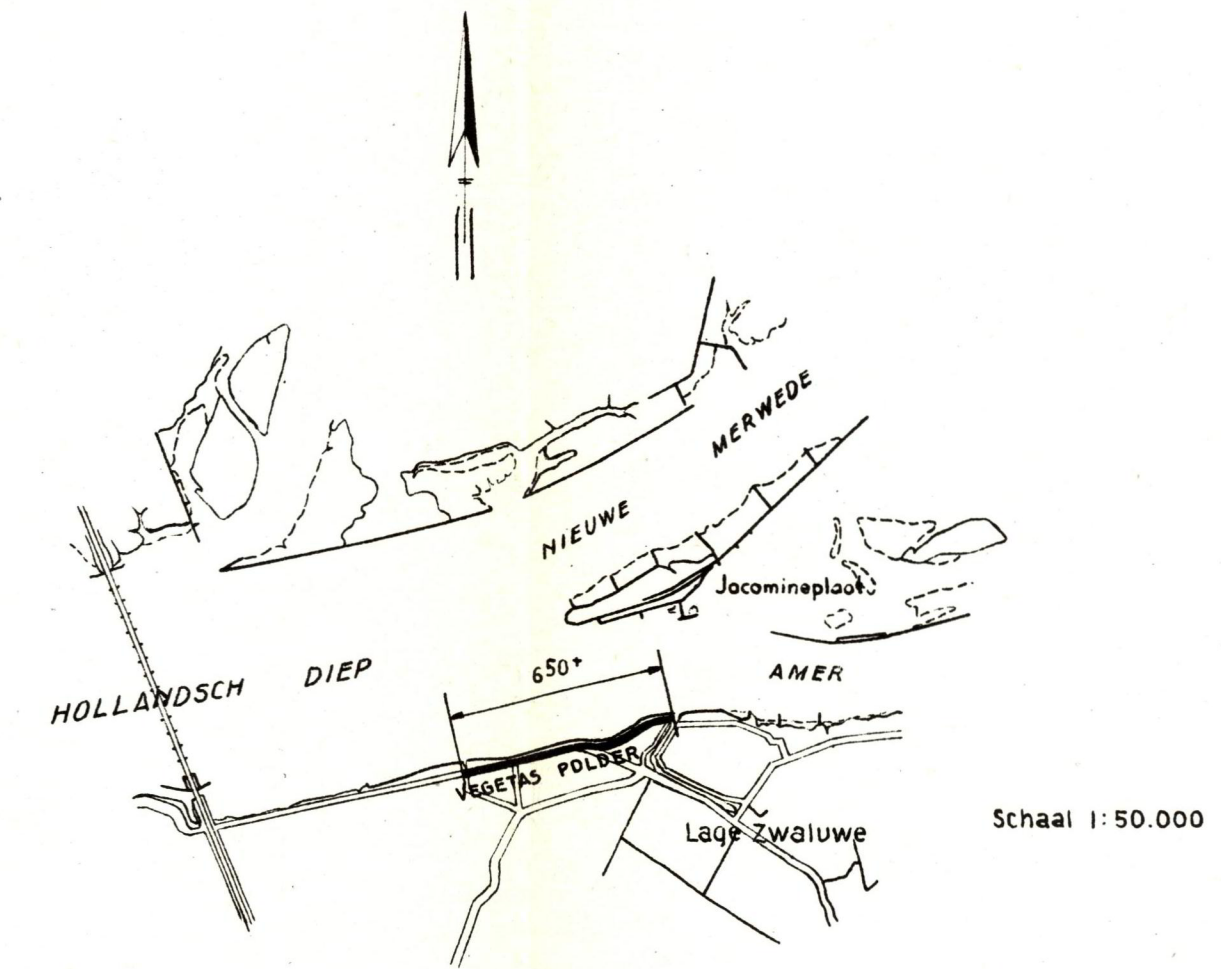
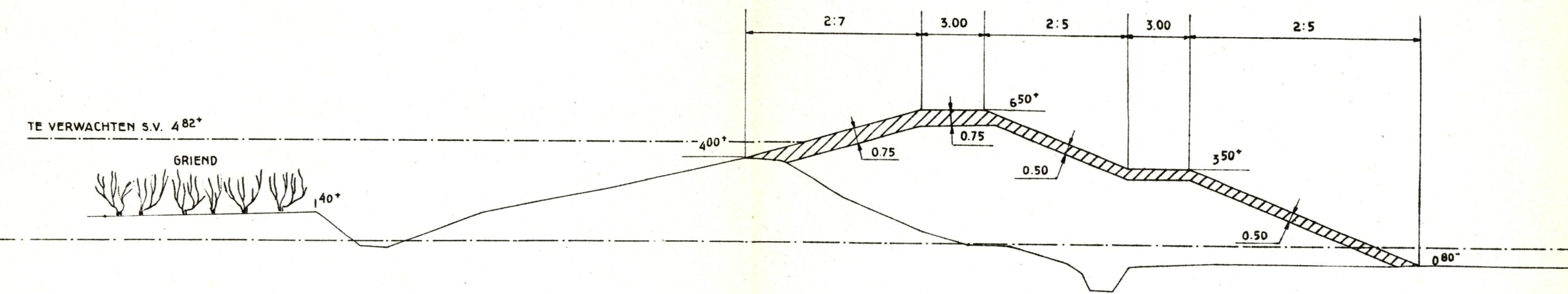

DJKSVERHOOGING ZUIDZIJDE BERGSCHER MAAS - DONGEMOND-DRIMMELEN RUKSWATERSTAAT 1940

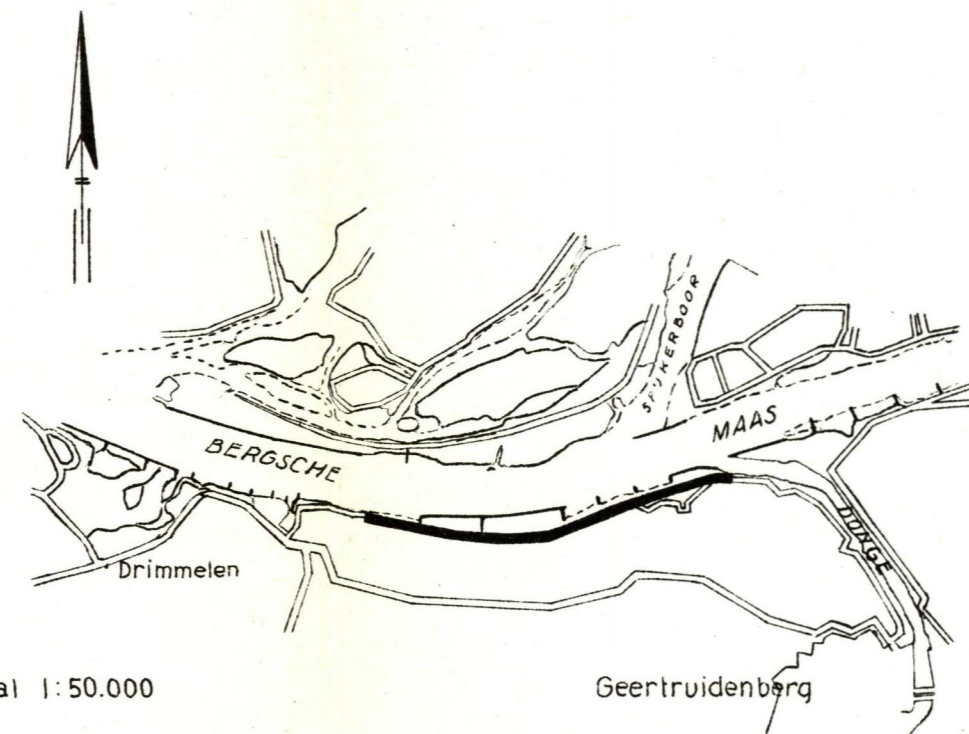
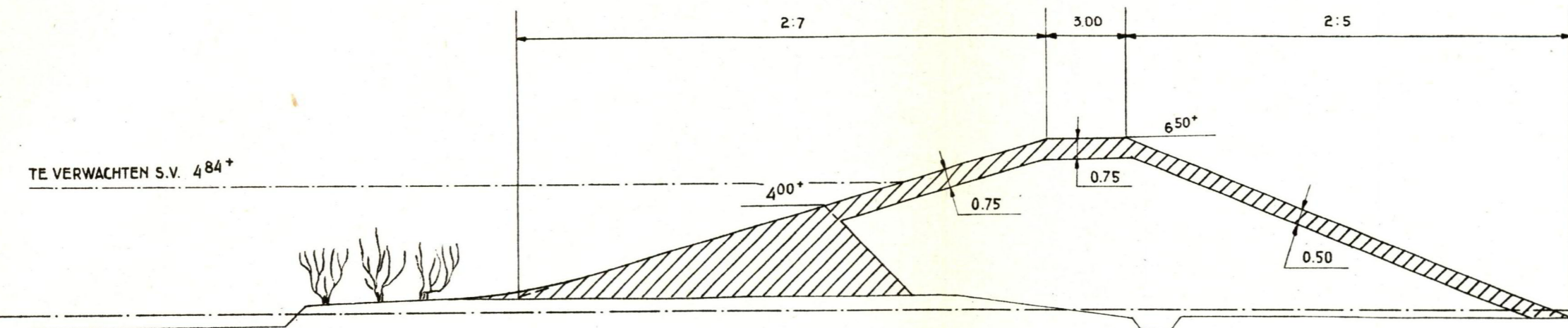

VERZWARING HOOGZANDSCHE DIJK PROV. WATERSTAAT IN ZUIDHOLLAND 1941

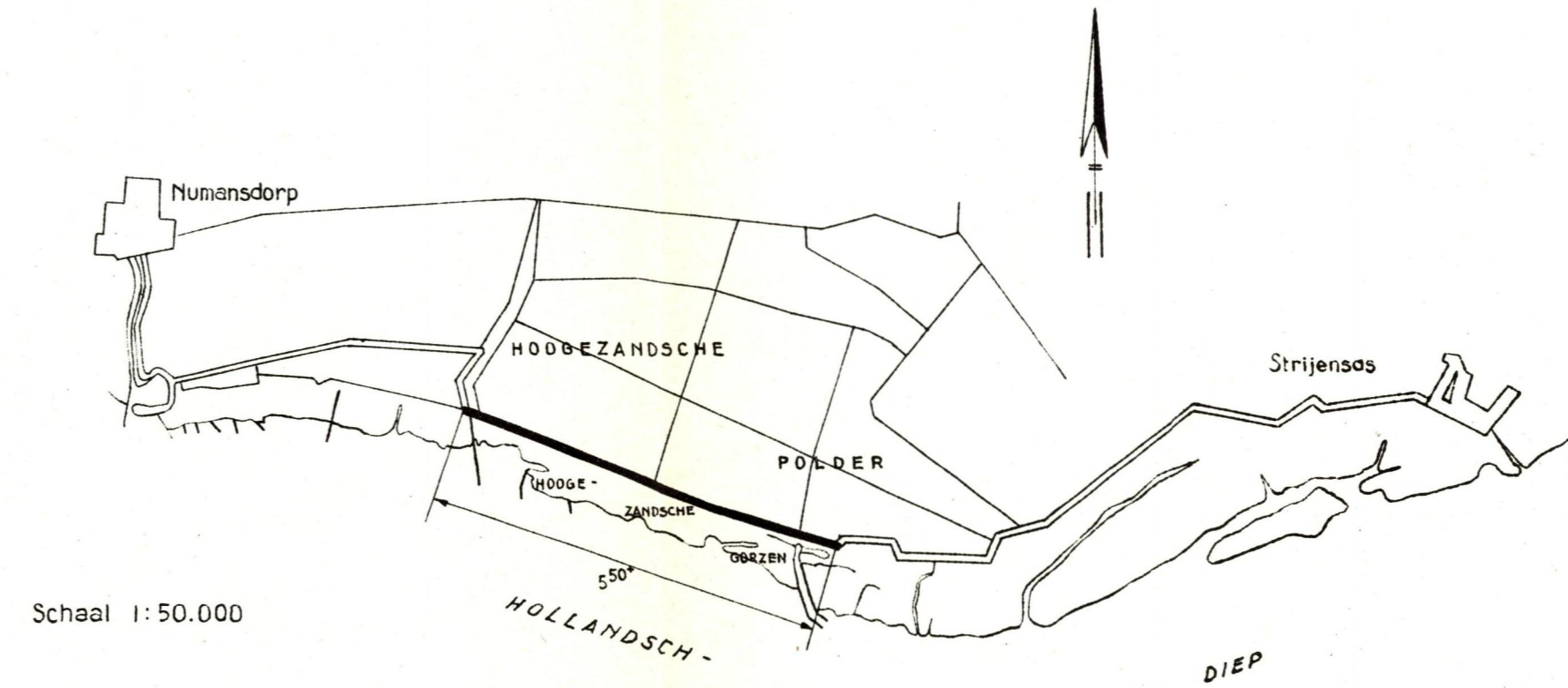
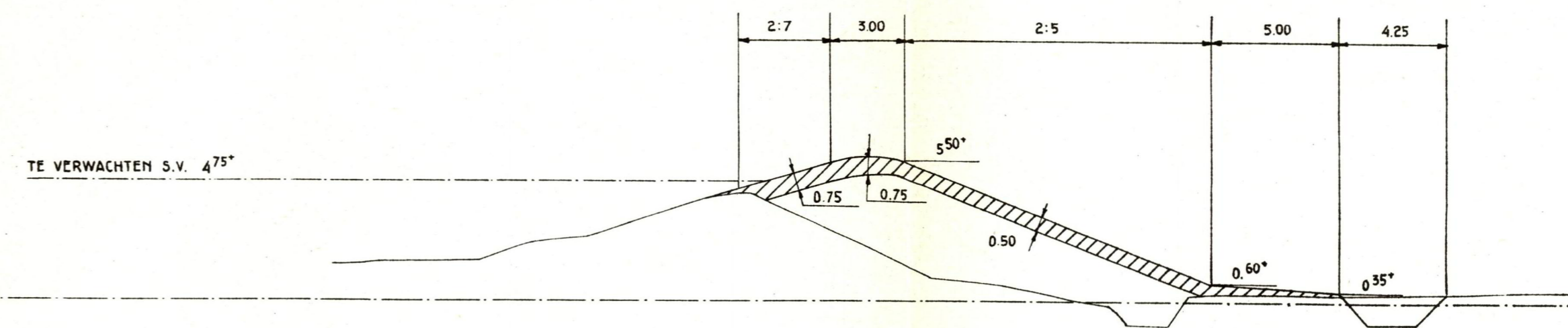

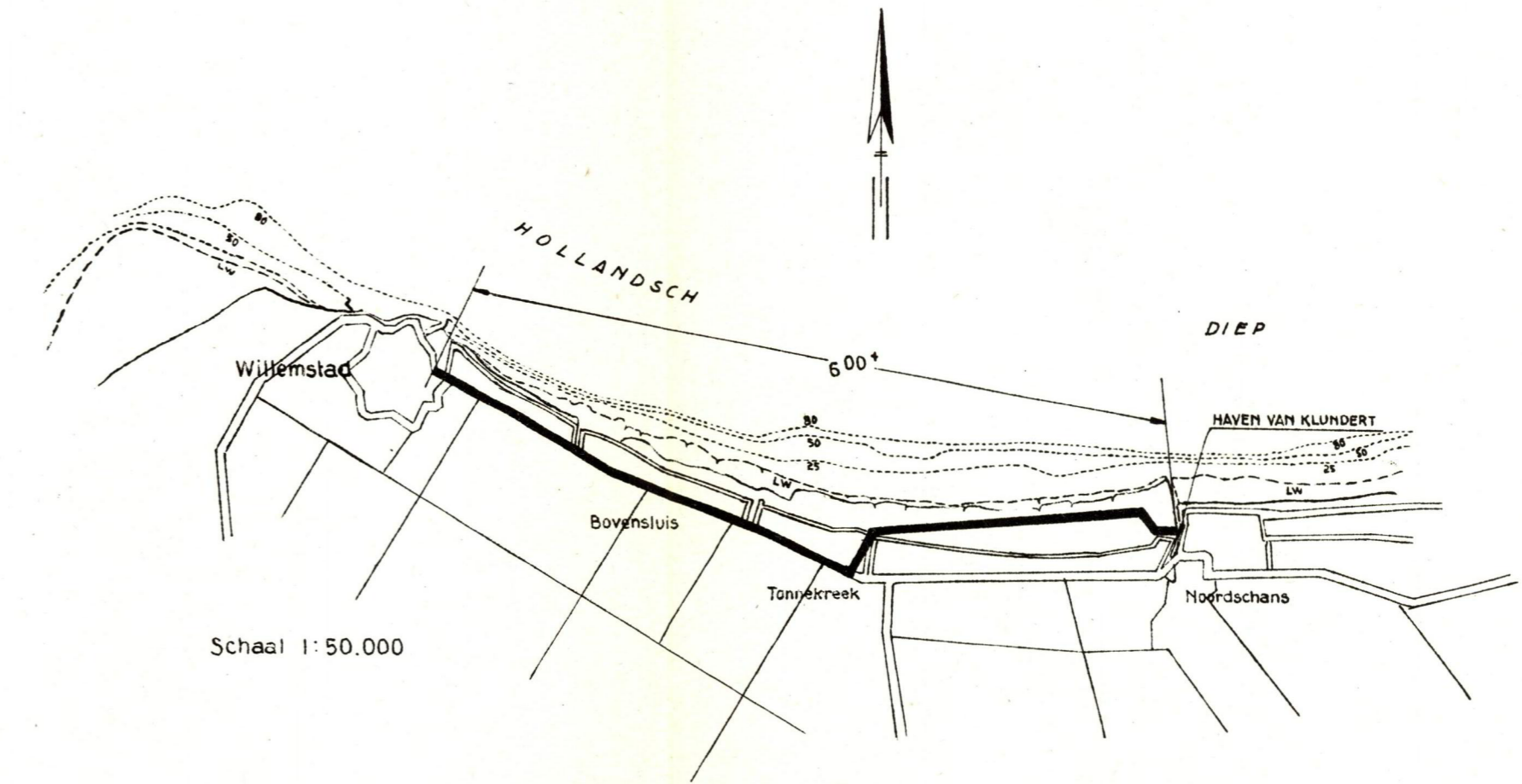
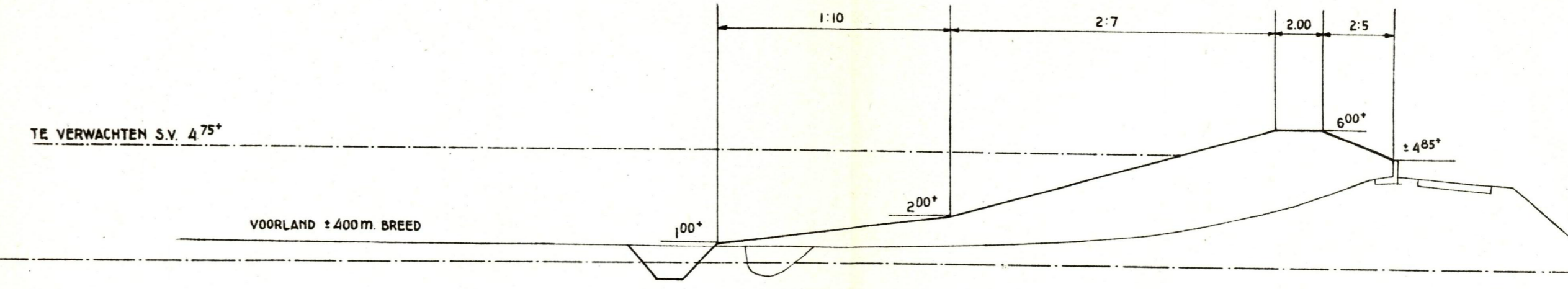
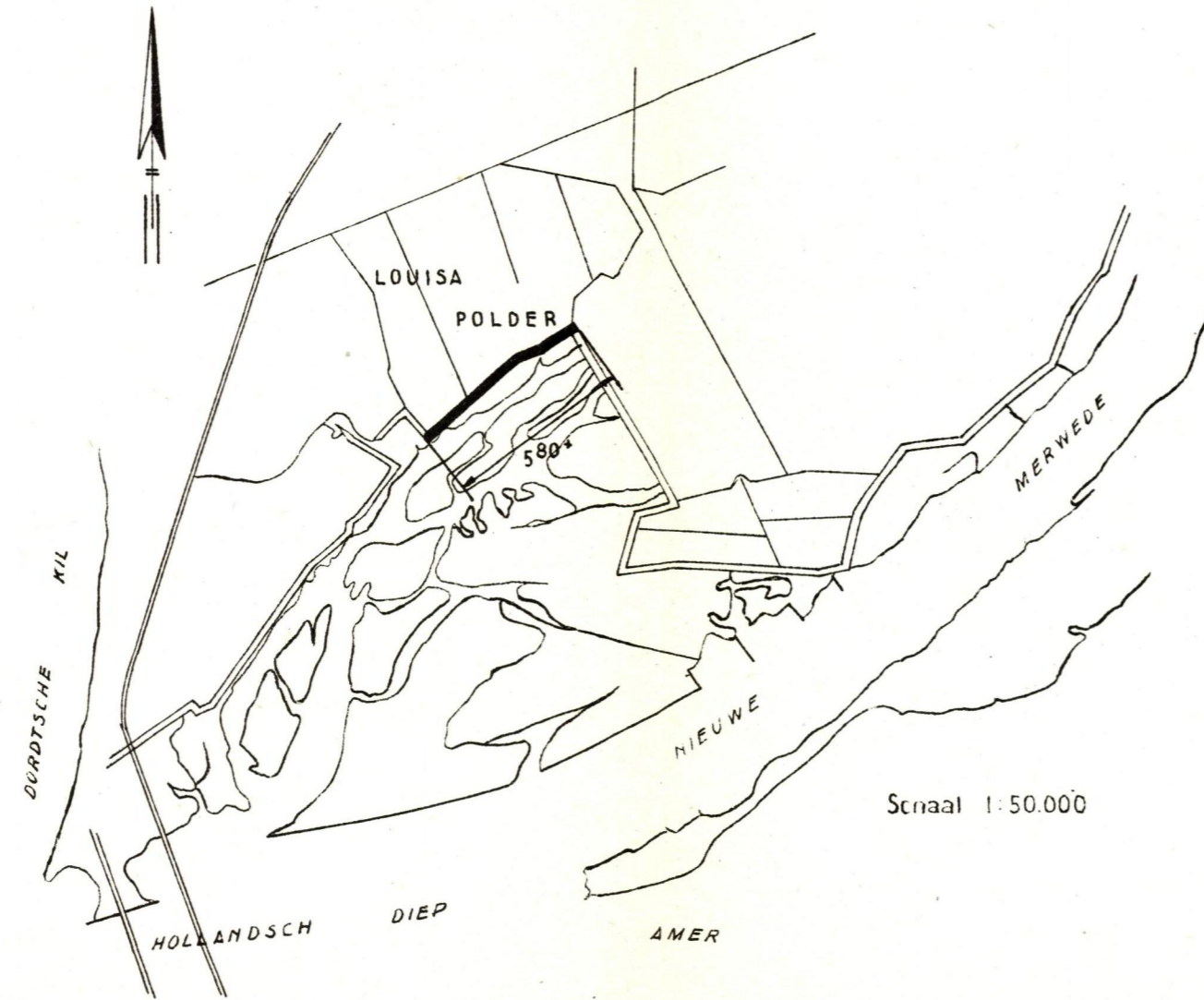
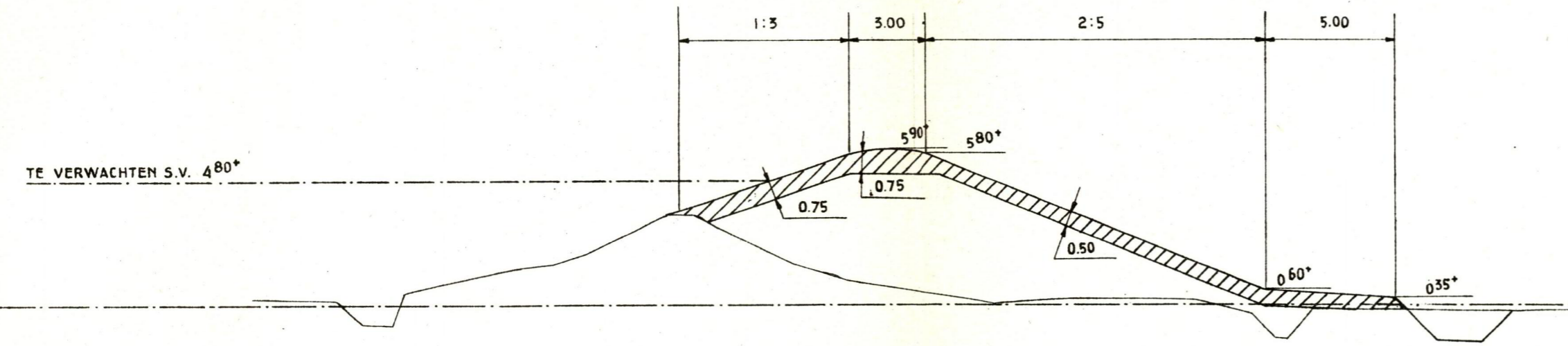

BEDUJING WILLEMSTAD - FORT SABINA

ONTWERP 1/6 PROV. WATERSTAAT IN NOORDBRABANT

PROF. 33

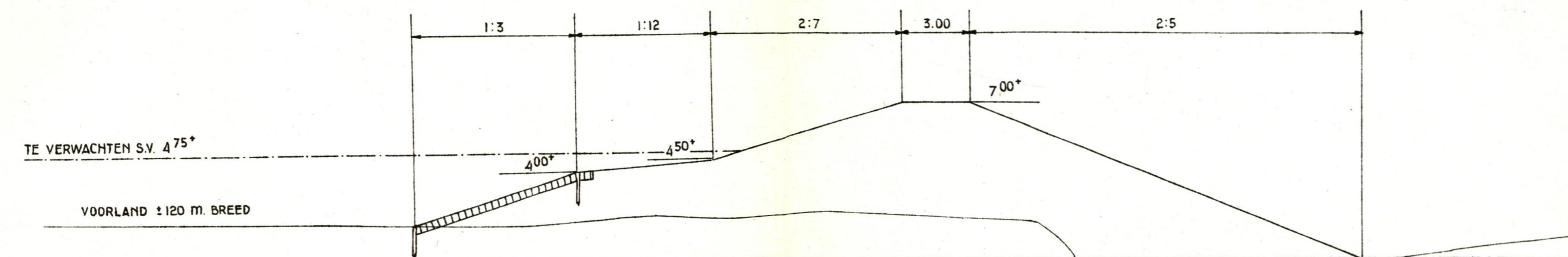

DIJKSVERHOOGING FORT SABINA - DINTELSAS

ONTWERP 1/6 PROV. WATERSTAAT IN NOORDBRABANT

PROF. 34

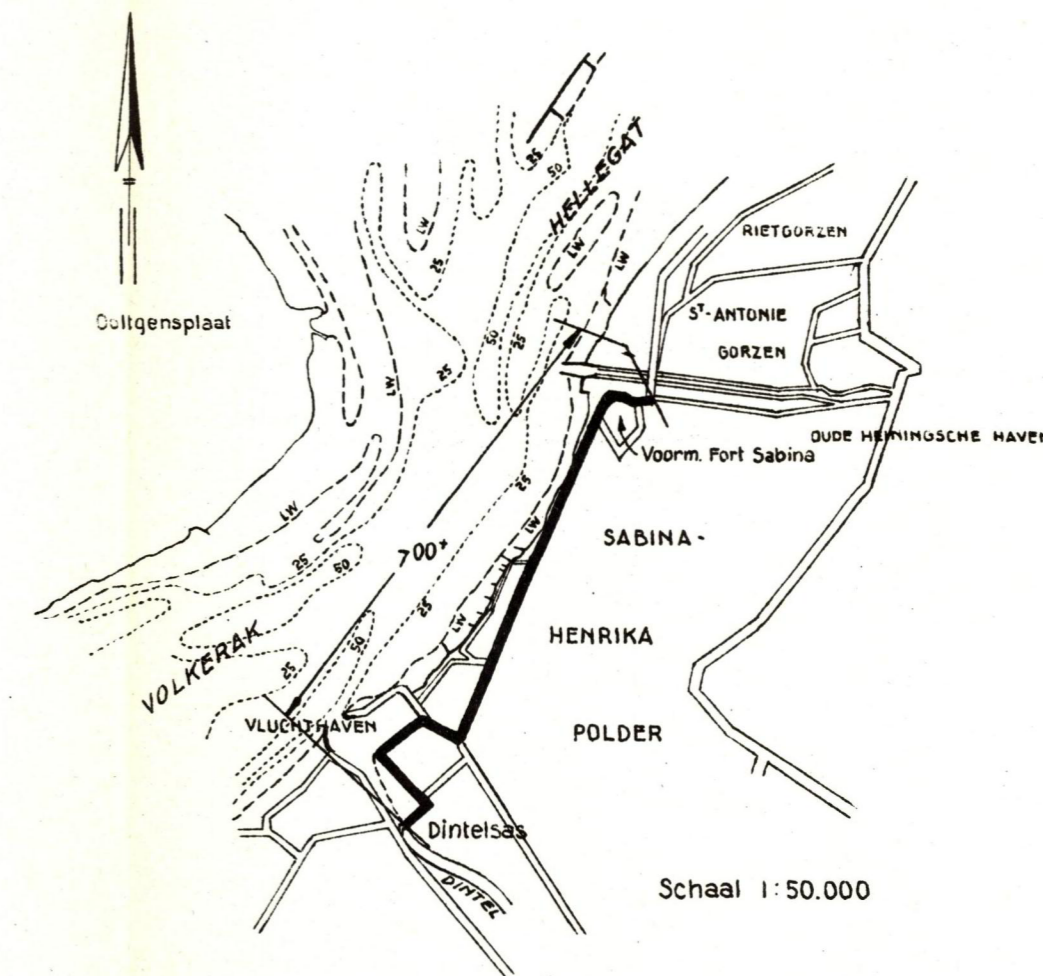
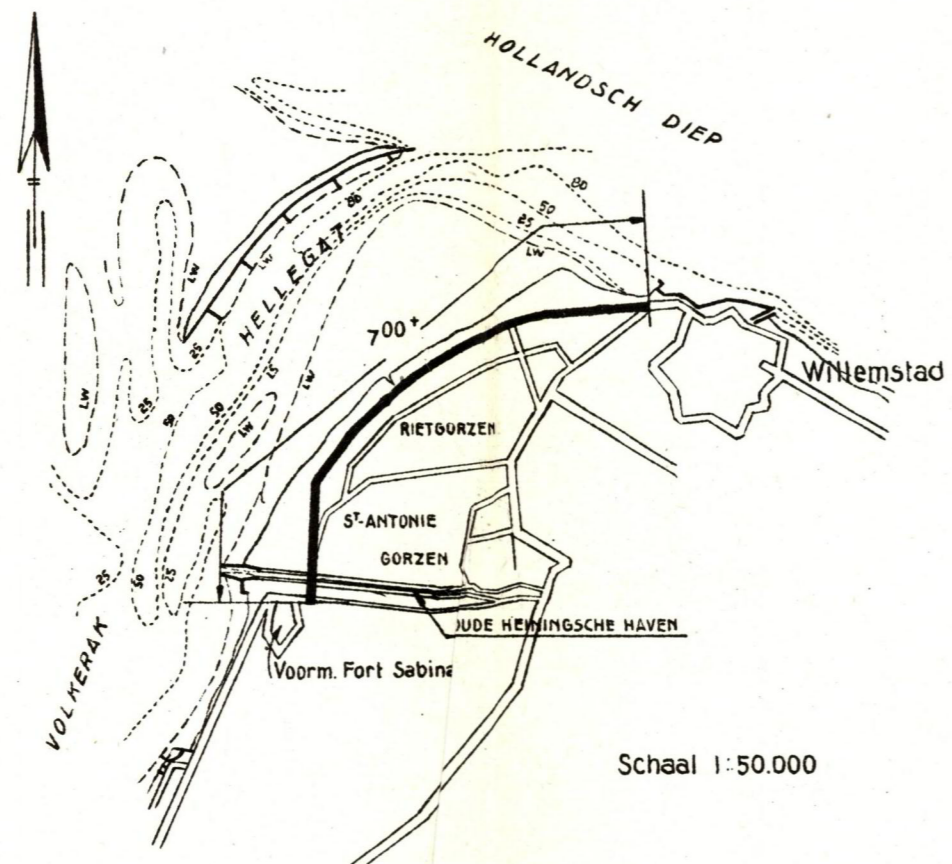
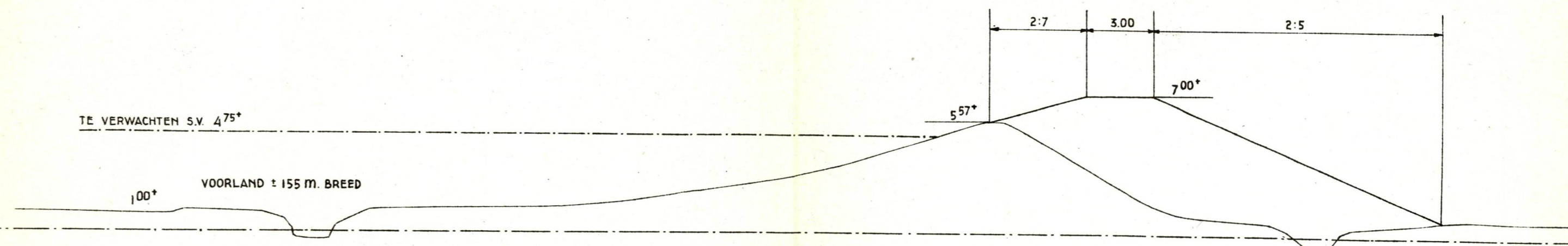

INDJING NOORDBRABANTSCH E BIESBOSCH
 GED EELTE WERKENDAM - SPIERINGSLUIS
 ONTWERP. VOORSTEL Prof.ir. J.Th. THUSSE

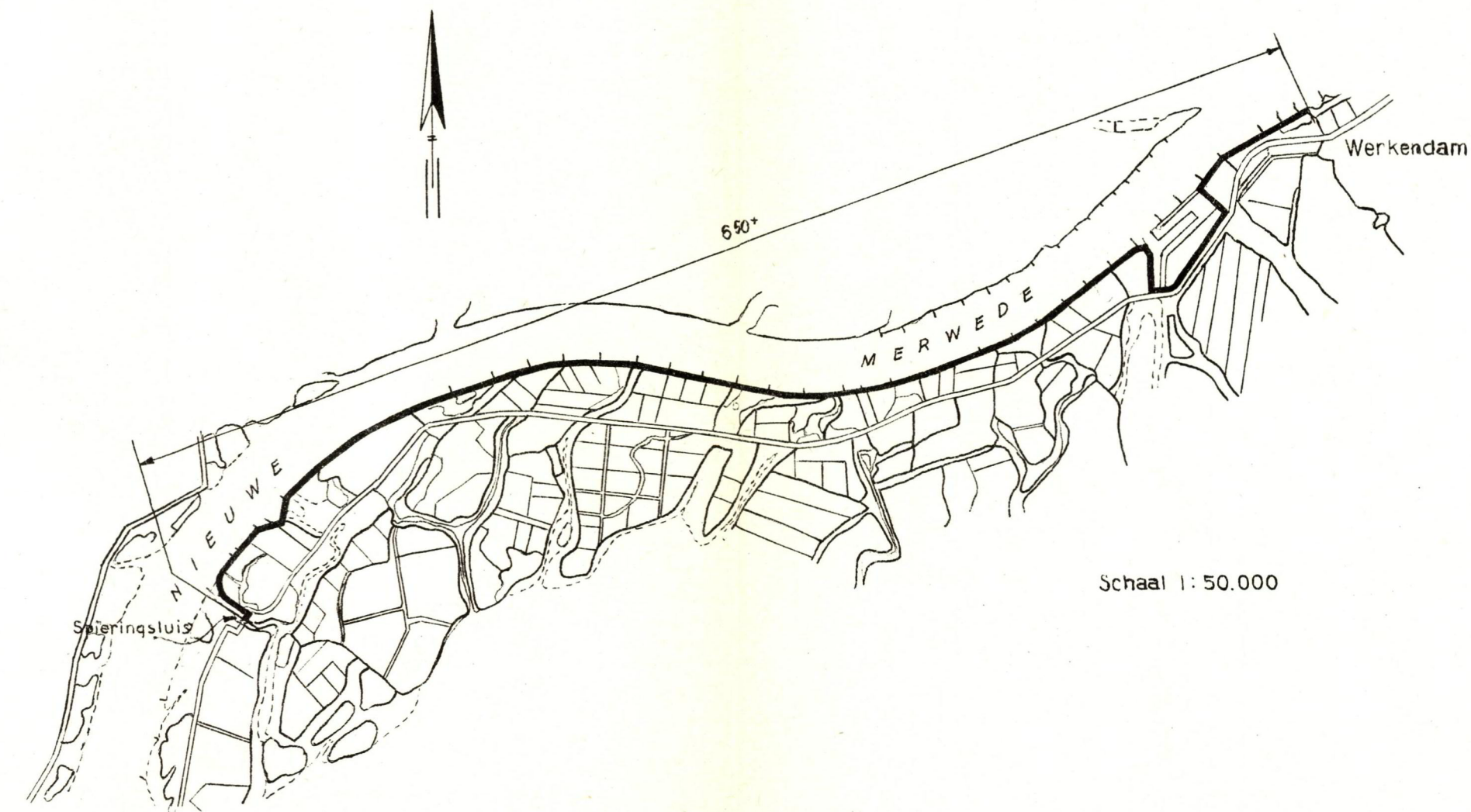
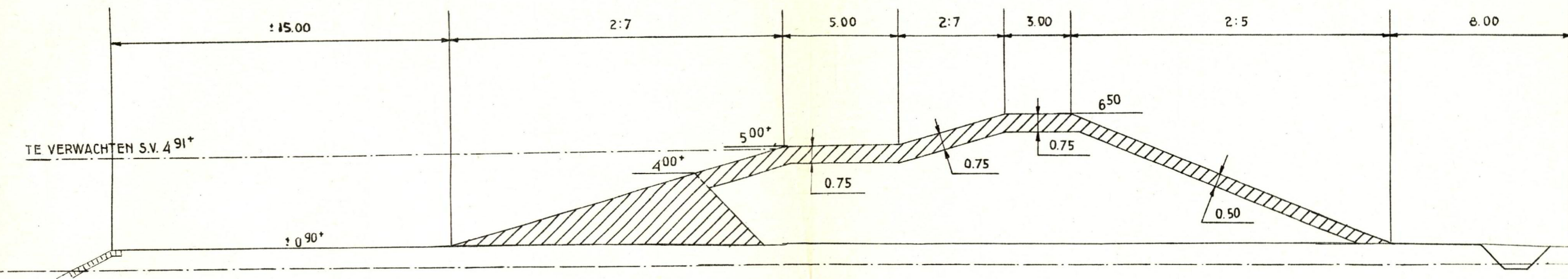

INDJING NOORDBRABANTSCH E BIESBOSCH
 GED EELTE SPIERINGSLUIS - DRIMMELEN
 ONTWERP. VOORSTEL Prof.ir. J.Th. THUSSE

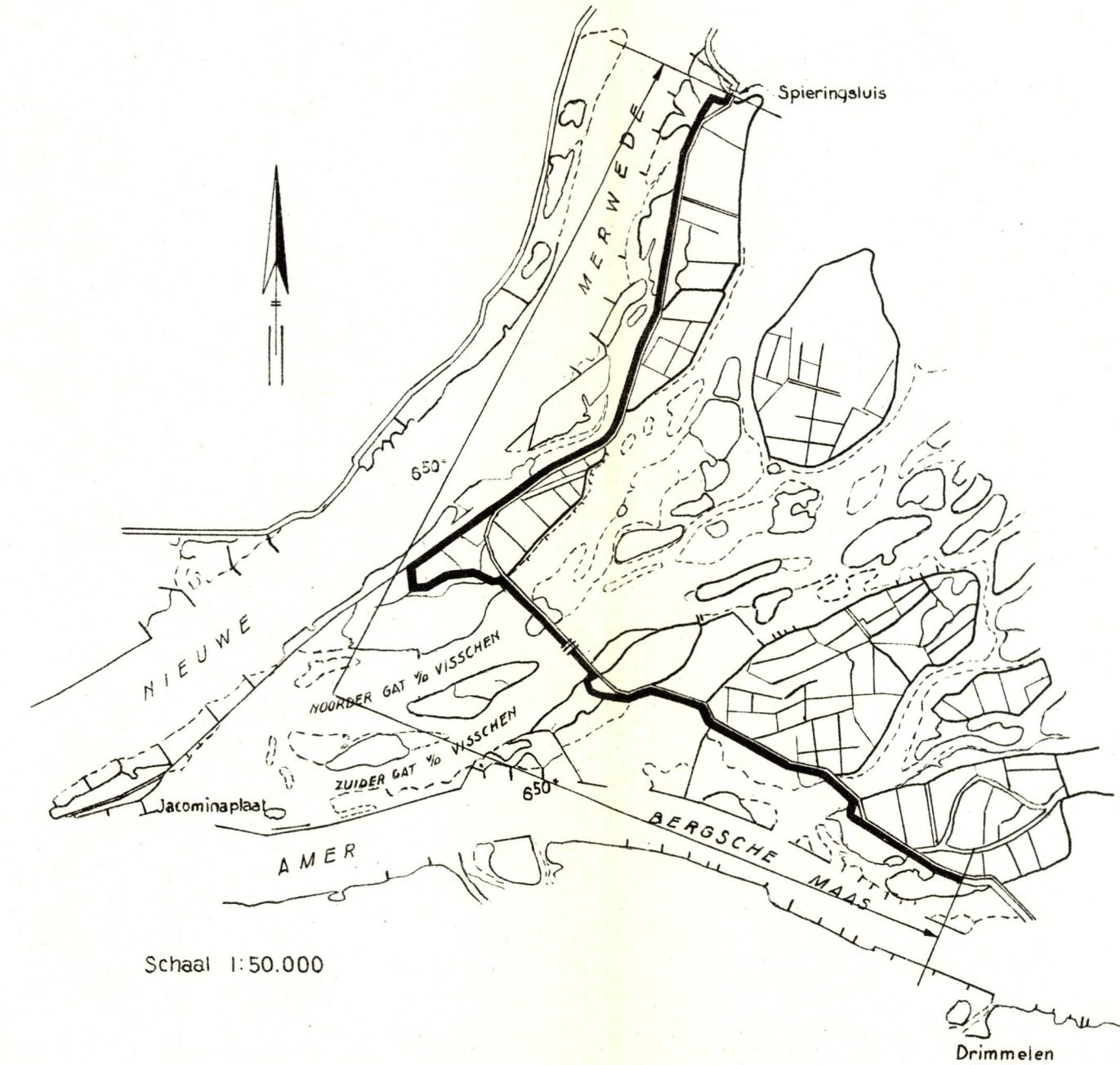
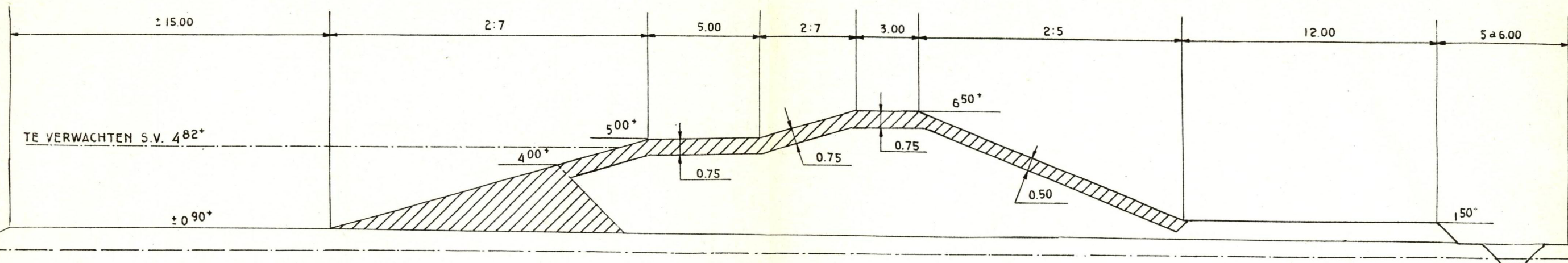

INDJUKING NOORDBRABANTSCH E BIESBOSCH ONTWERP. VOORSTEL Prof. ir. J.Th. THUSSE
GEDEELTE DRIMMELN-KEIZERSVEER

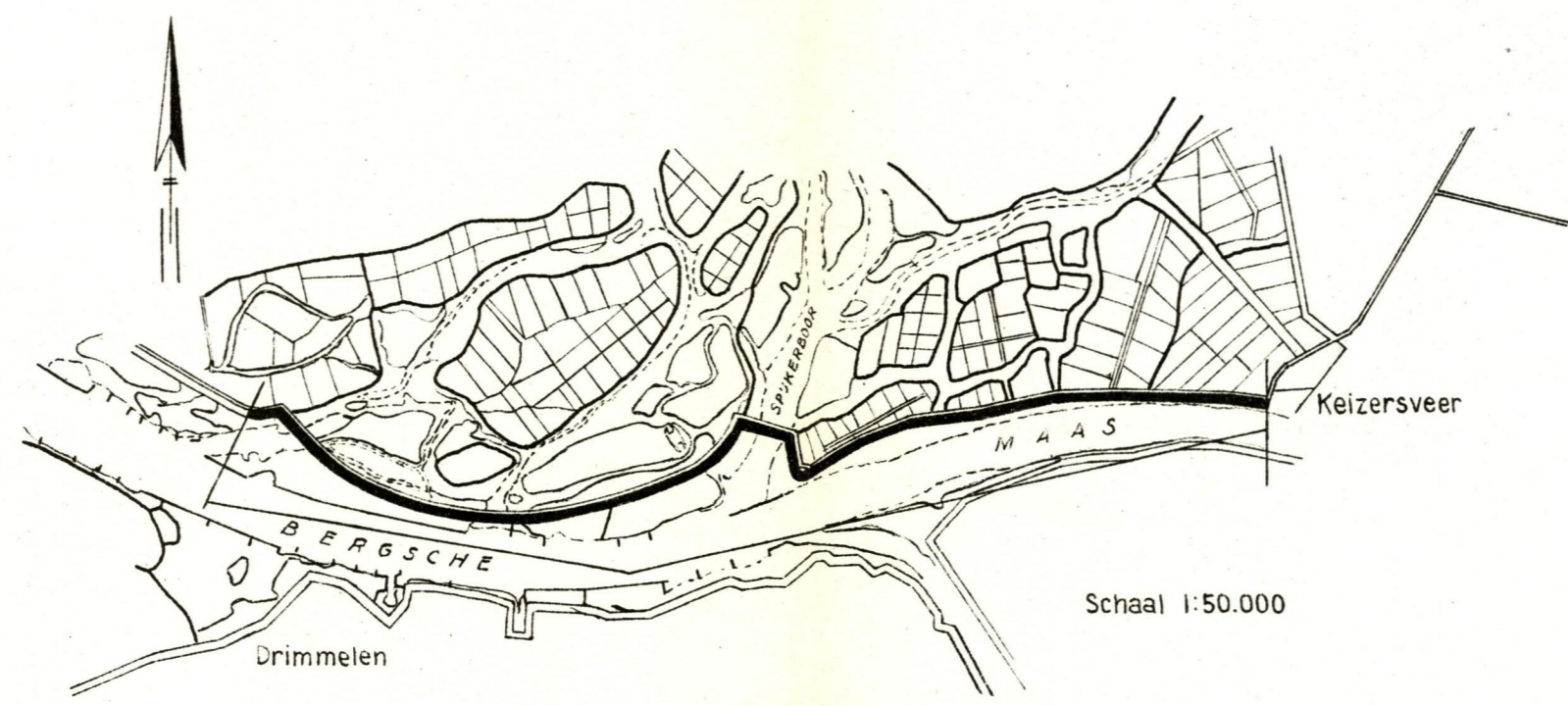
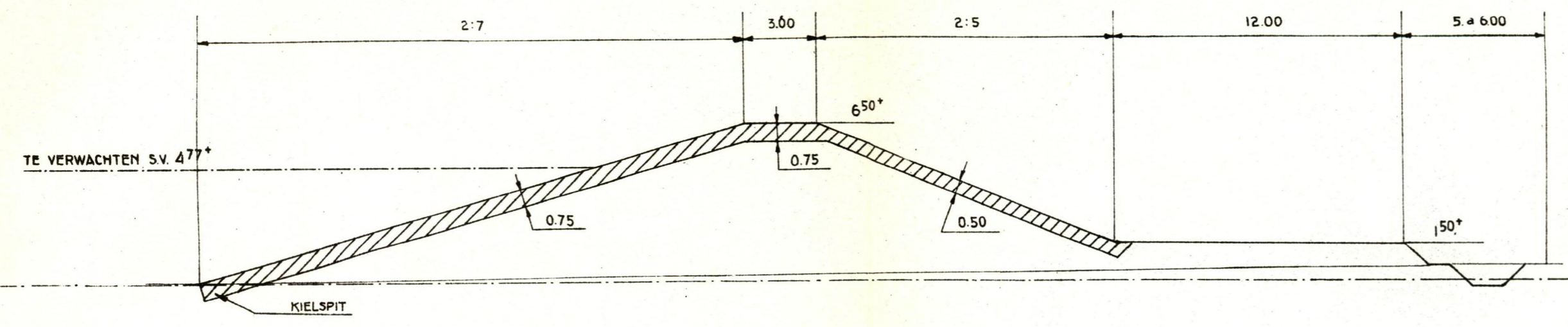

INDJUKING NOORDBRABANTSCH E BIESBOSCH ONTWERP. VOORSTEL H-ir. P.Ph. JANSEN

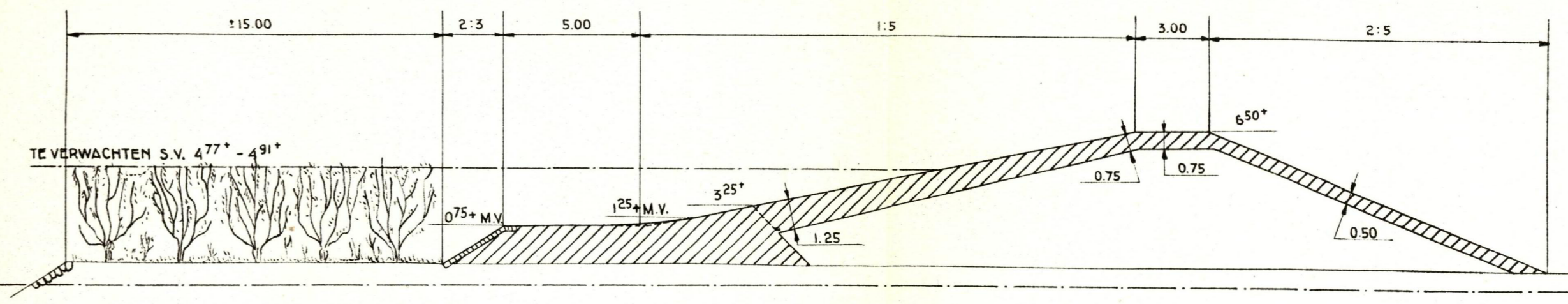

SCHIELANDS HOOG E ZEED'JK OPGENOMEN DOOR HET LABORATORIUM VOOR GRONDMECHANICA TE DELFT
PROFIEL IN RAAI 185 70

