

DIJK VAN DE POLDER NIEUW BONAVENTURA

DIJKVAK 11

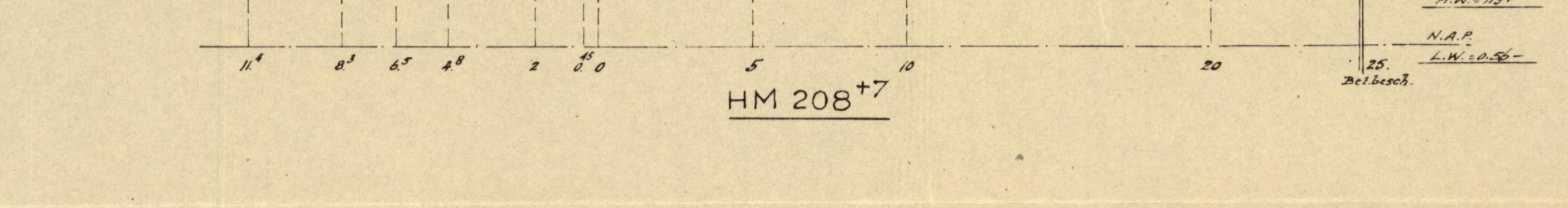

DIJK VAN HET LANDIGJE BEVERSHOEK

DIJKVAK 12

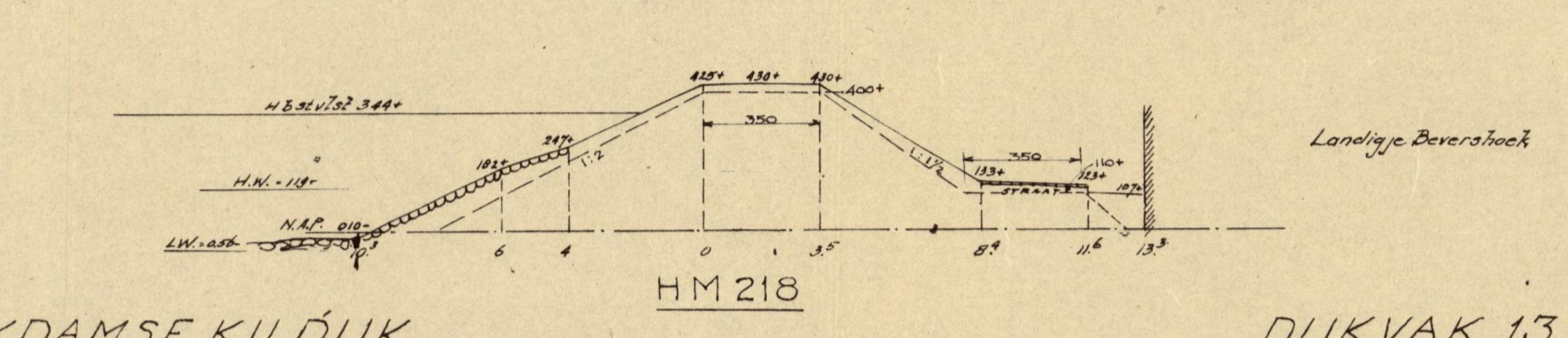
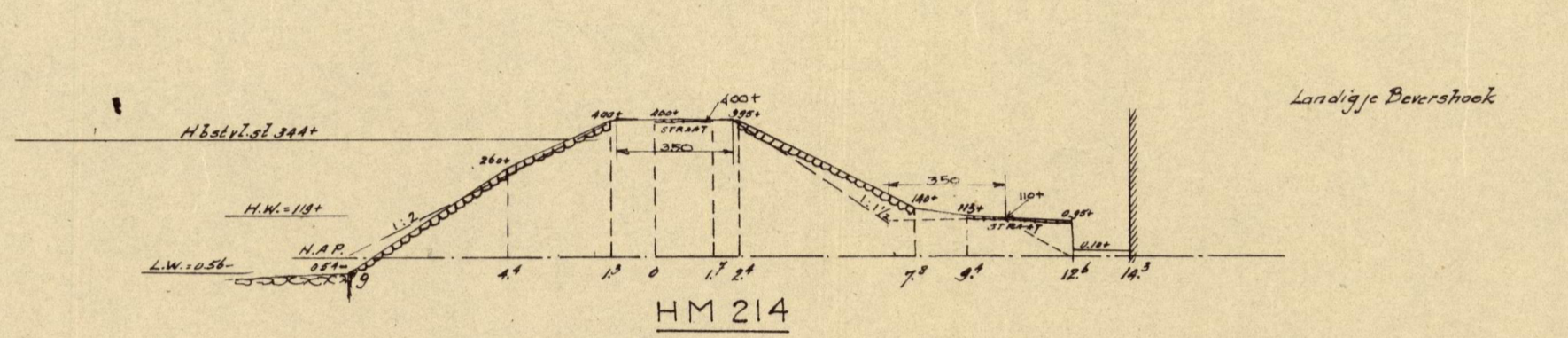
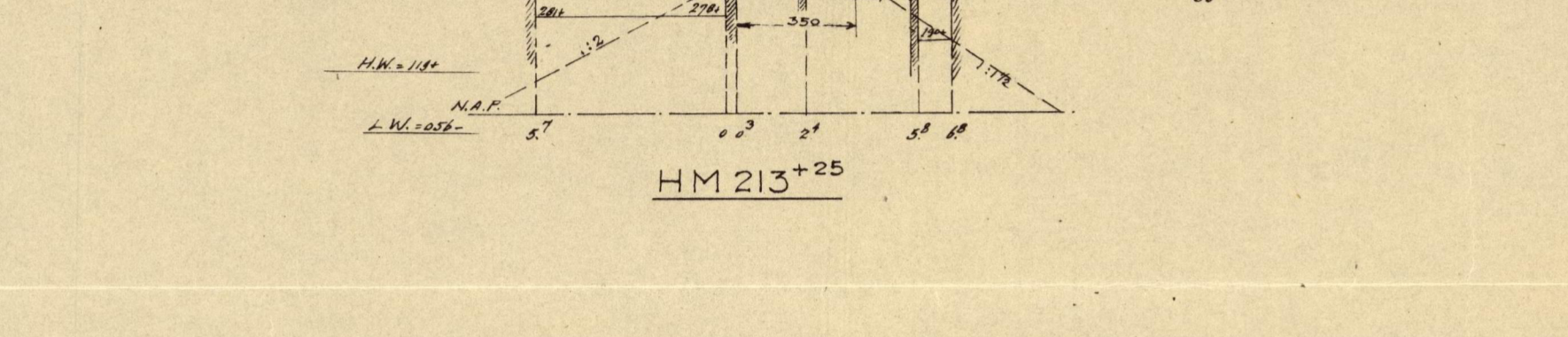
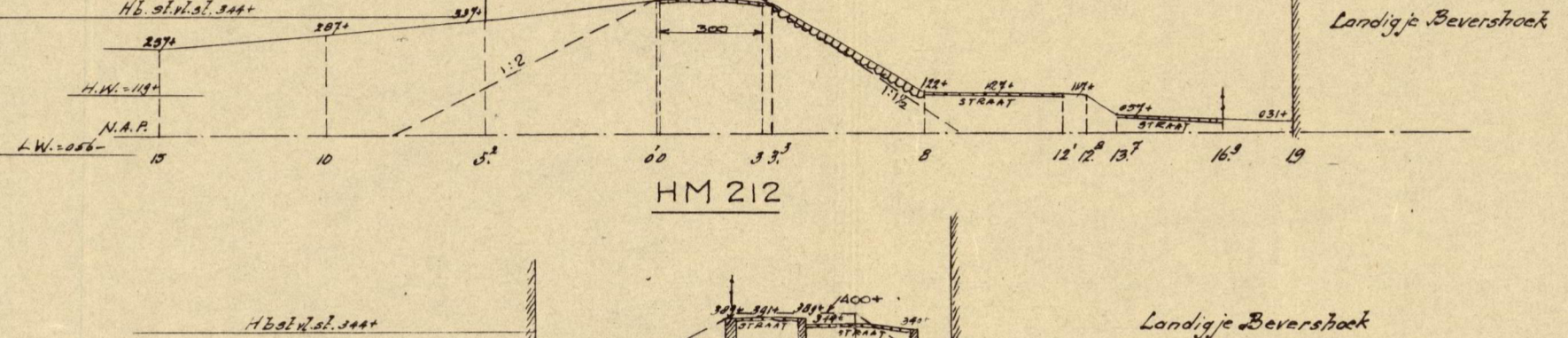
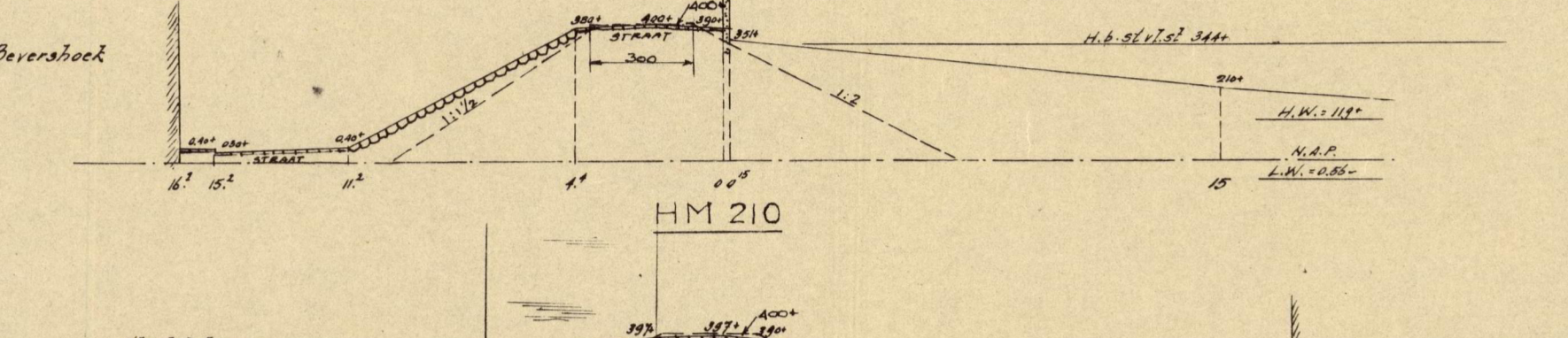
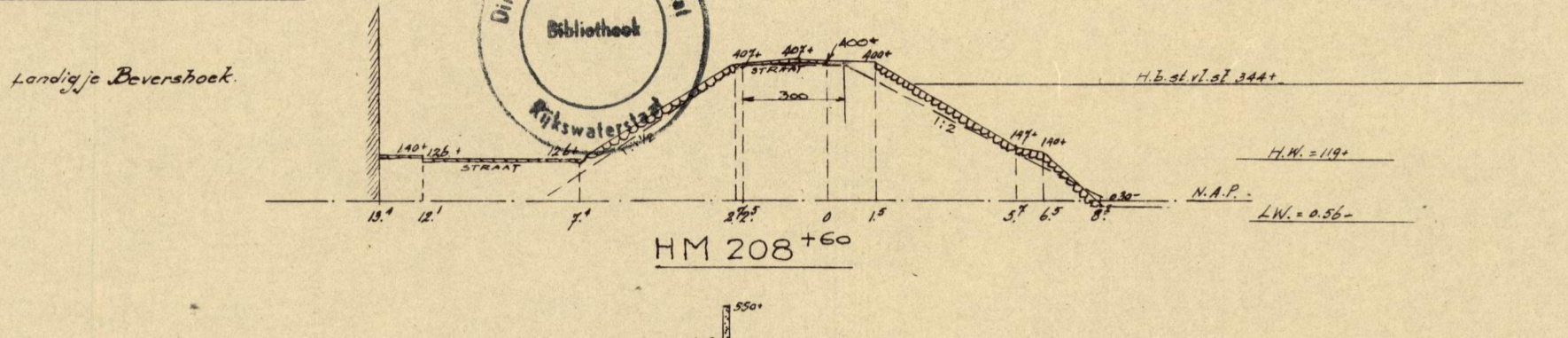

TREK DAMSE KILDIAK

DIJKVAK 13

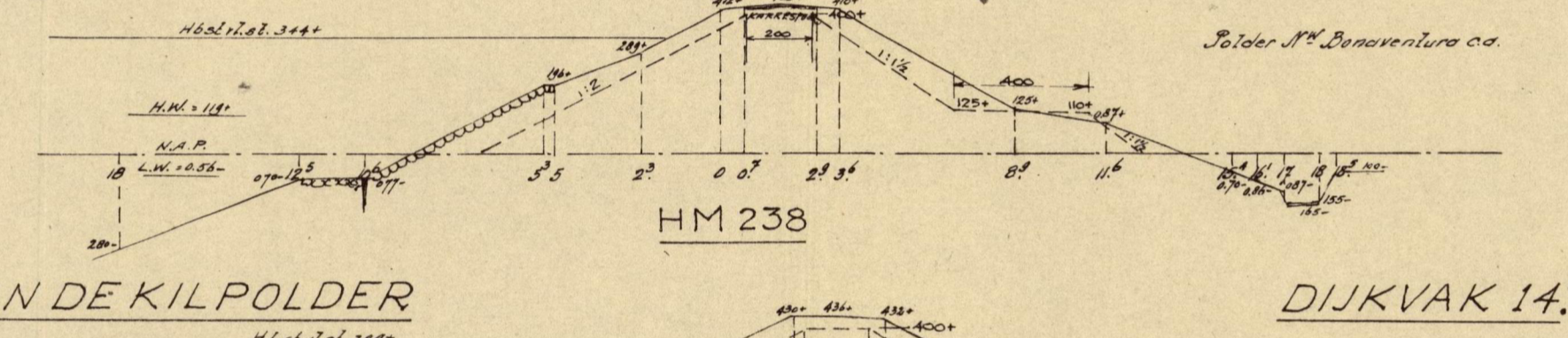
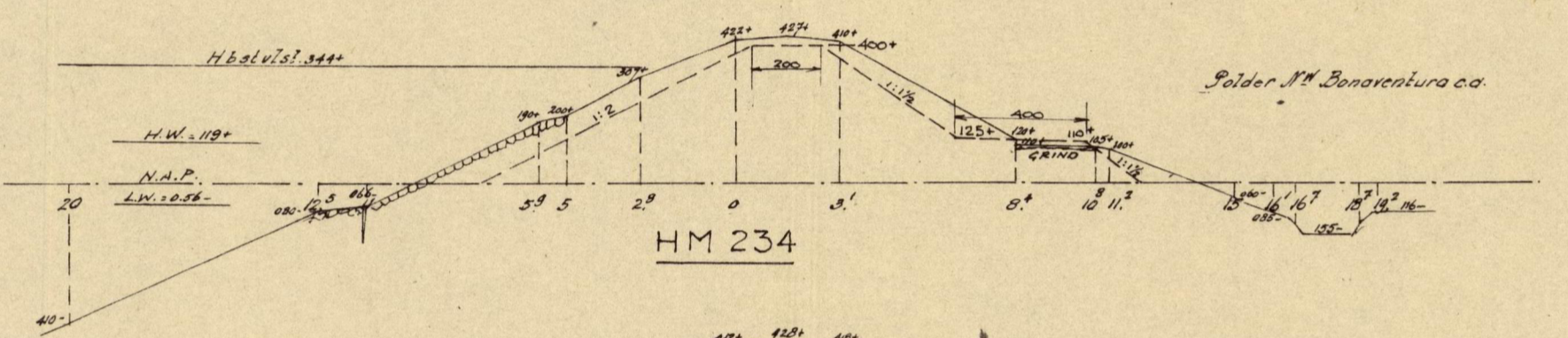
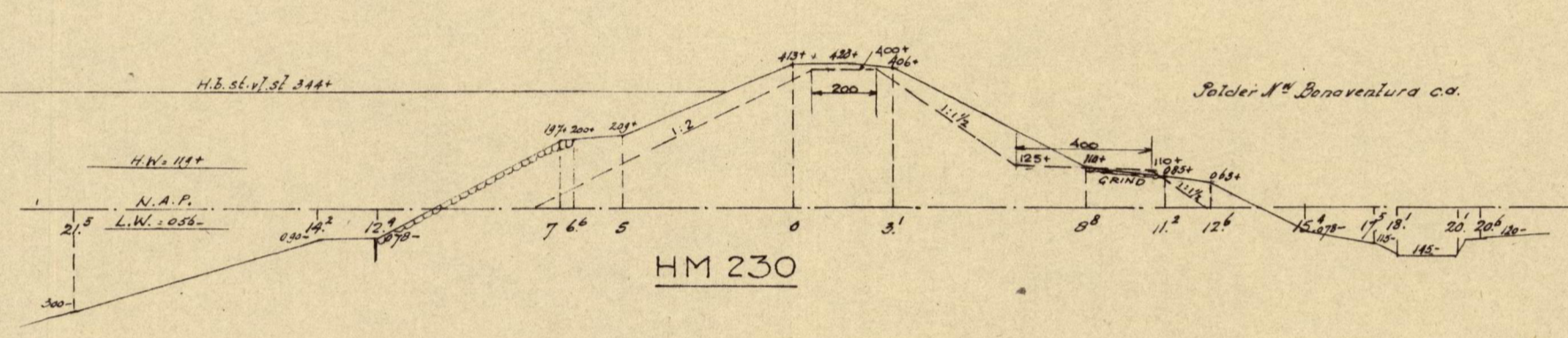
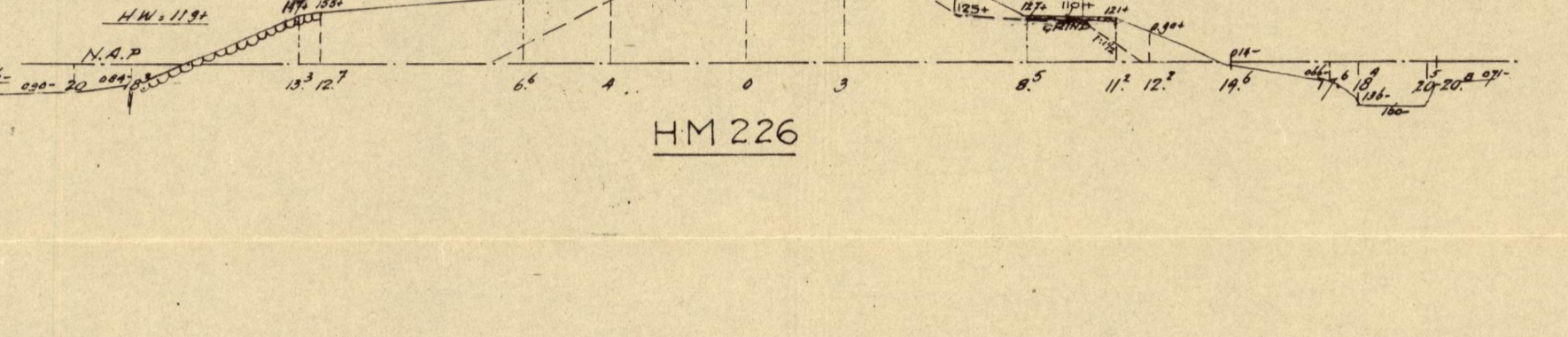
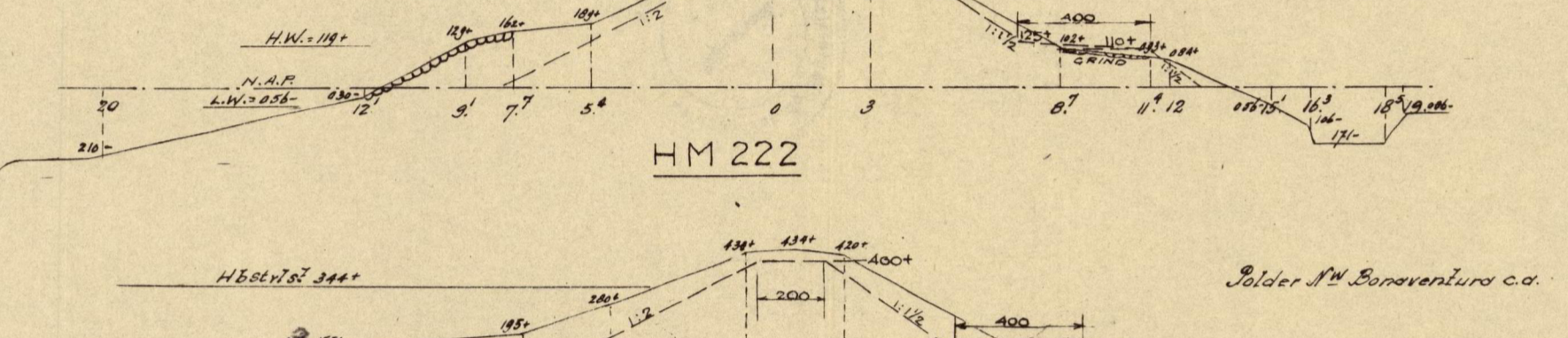

DIJK VAN DE KILPOLDER

DIJKVAK 14.A

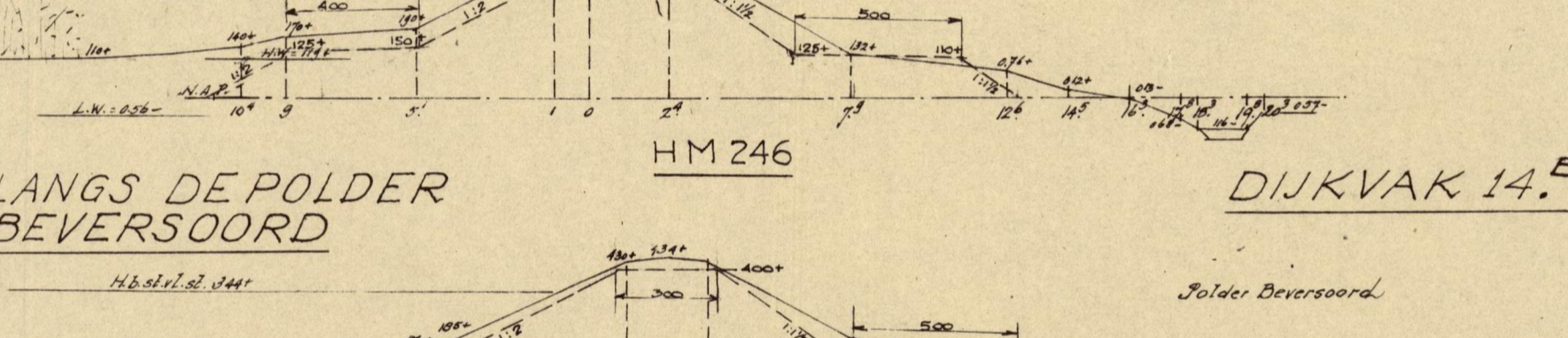
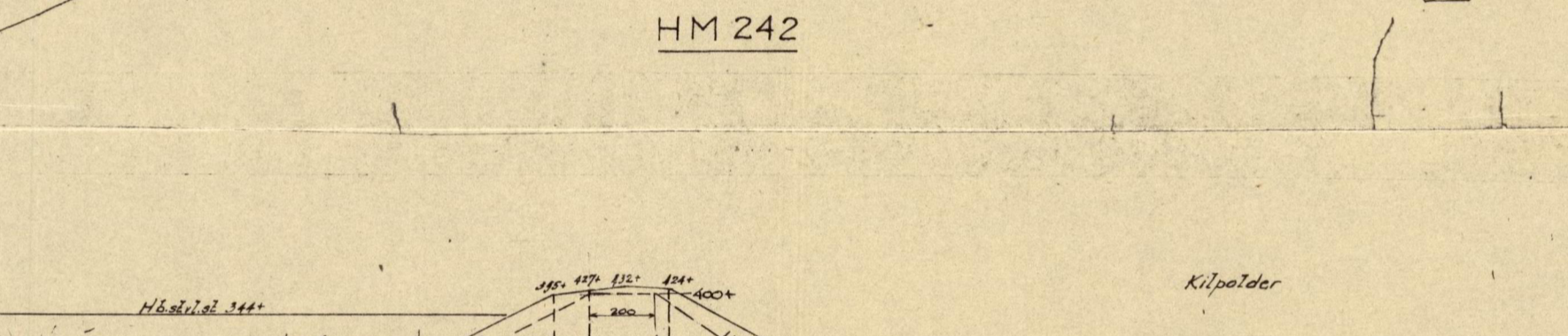

DIJK LANGS DE POLDER BEVERSOORD

DIJKVAK 14.B

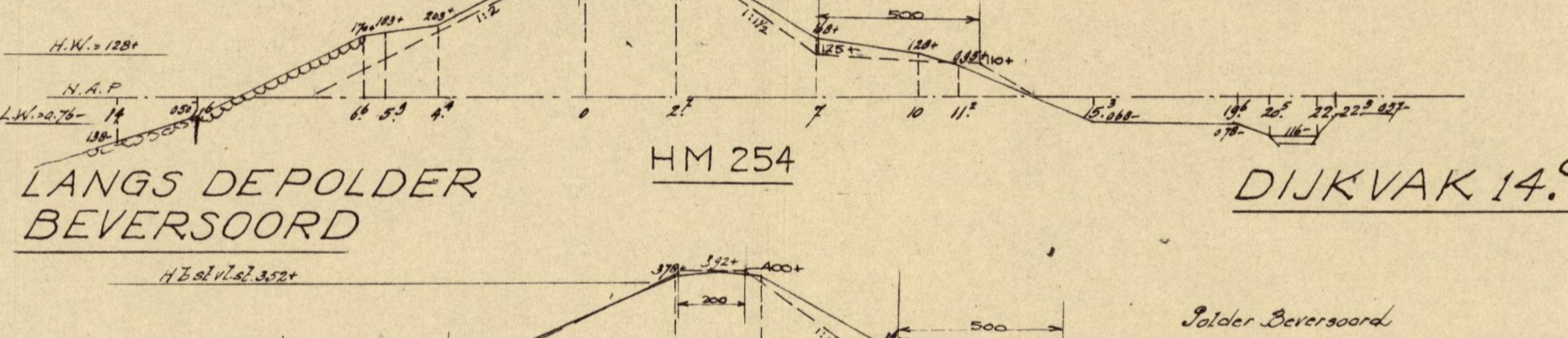
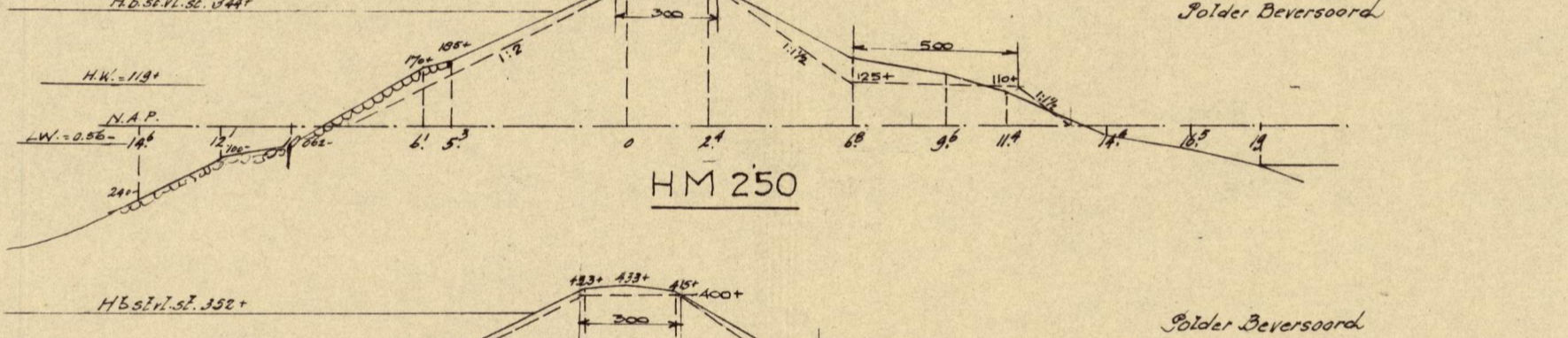

DIJK LANGS DE POLDER BEVERSOORD

DIJKVAK 14.C

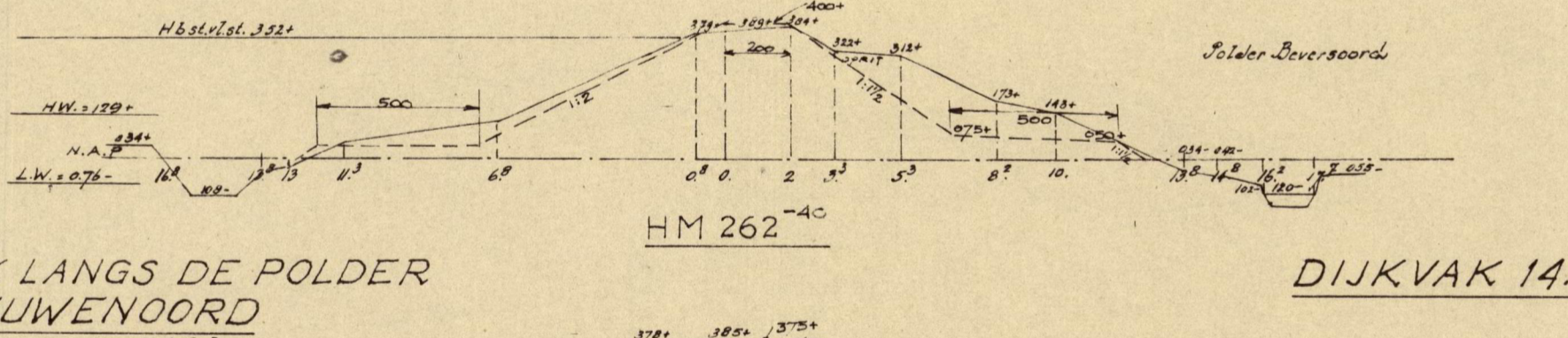
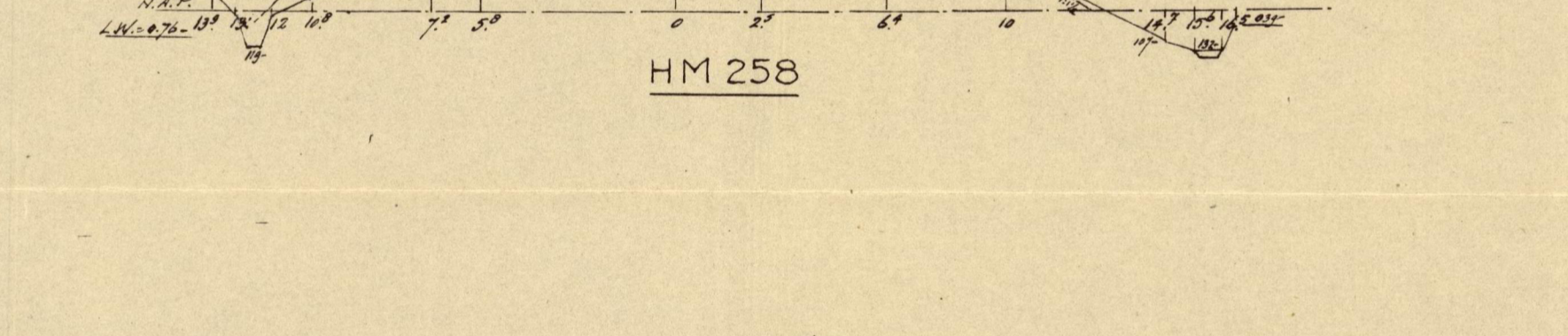

DIJK LANGS DE POLDER MEEUWENOORD

DIJKVAK 14.D

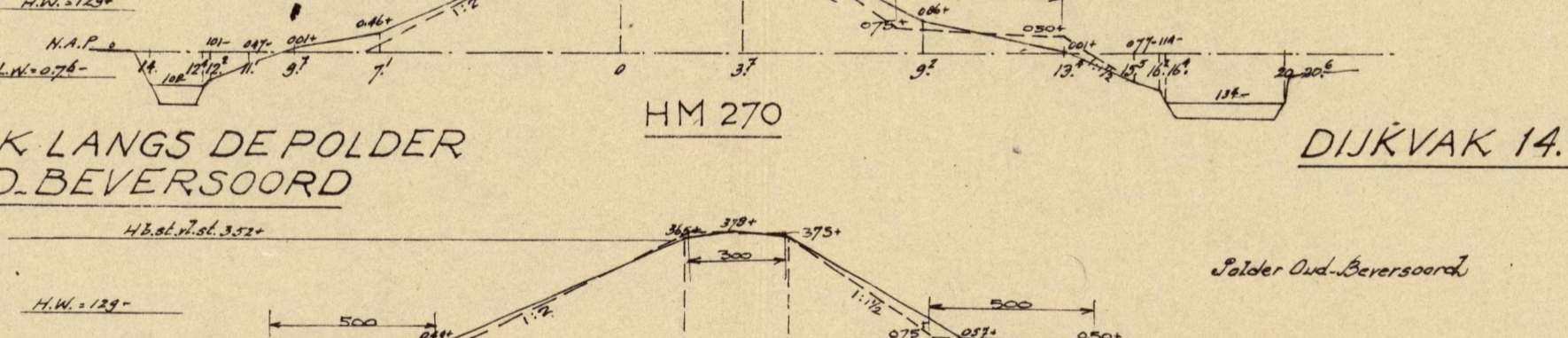
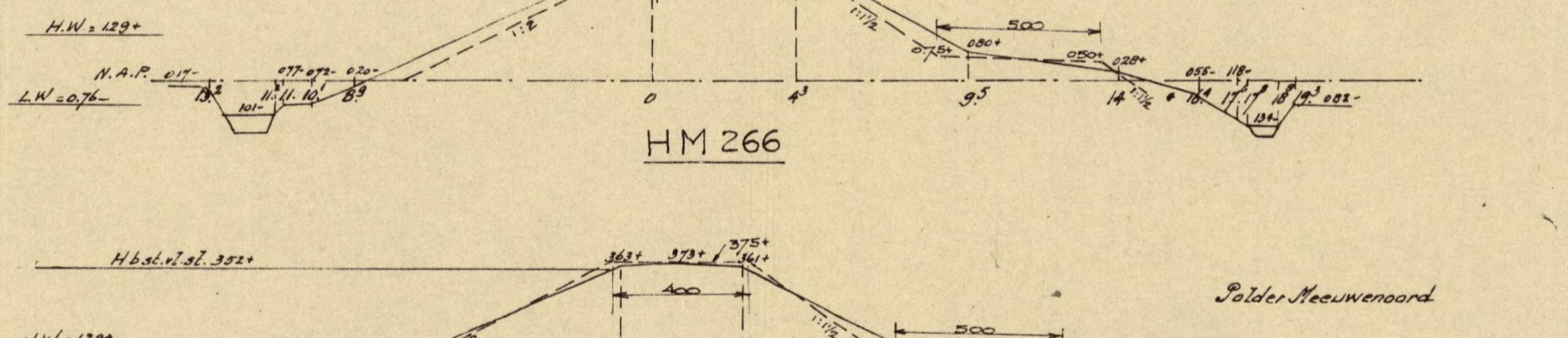

DIJK LANGS DE POLDER OUD BEVERSOORD

DIJKVAK 14.E

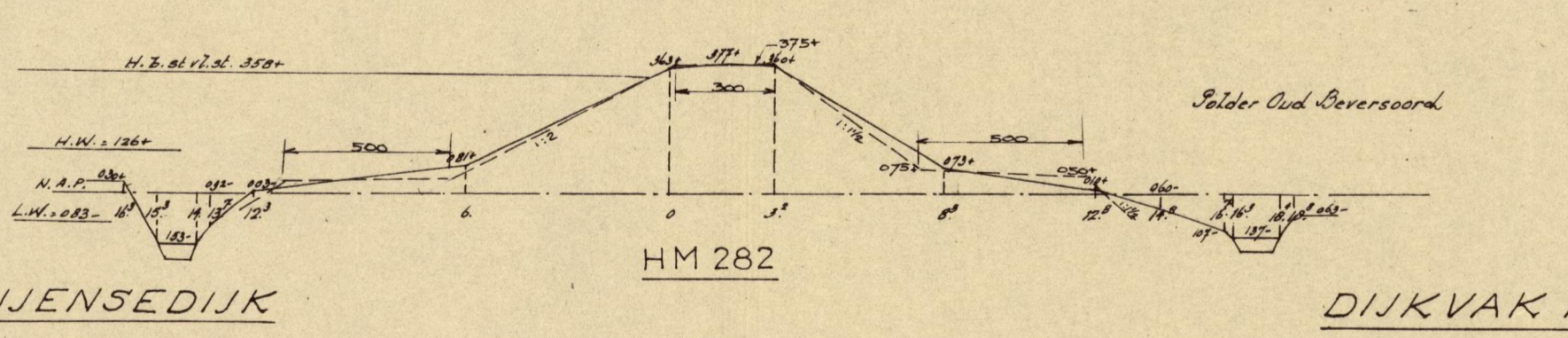
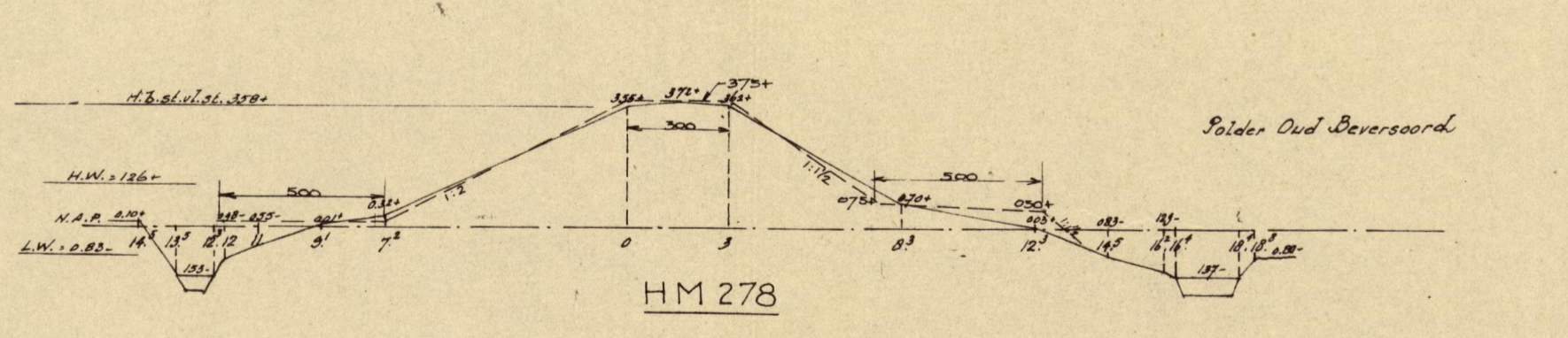
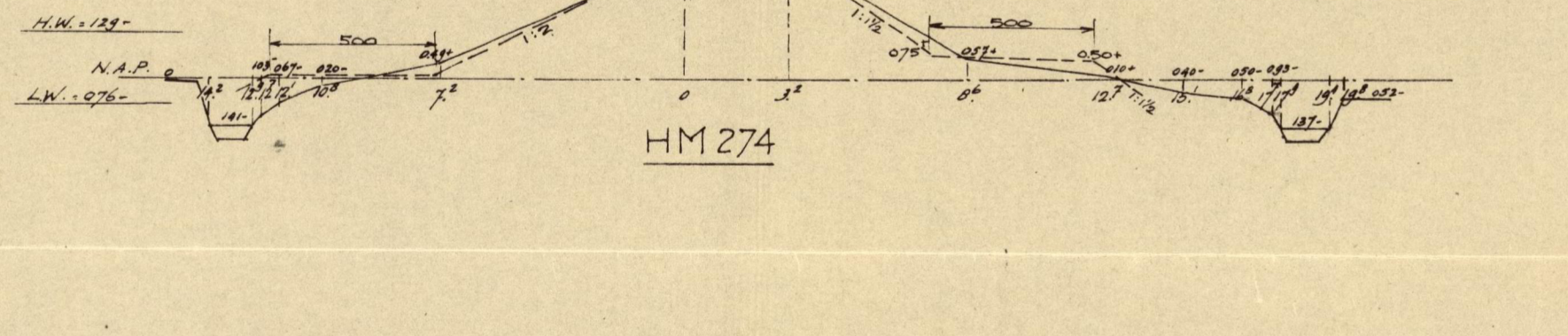

STRIJENSEDIJK

DIJKVAK 15

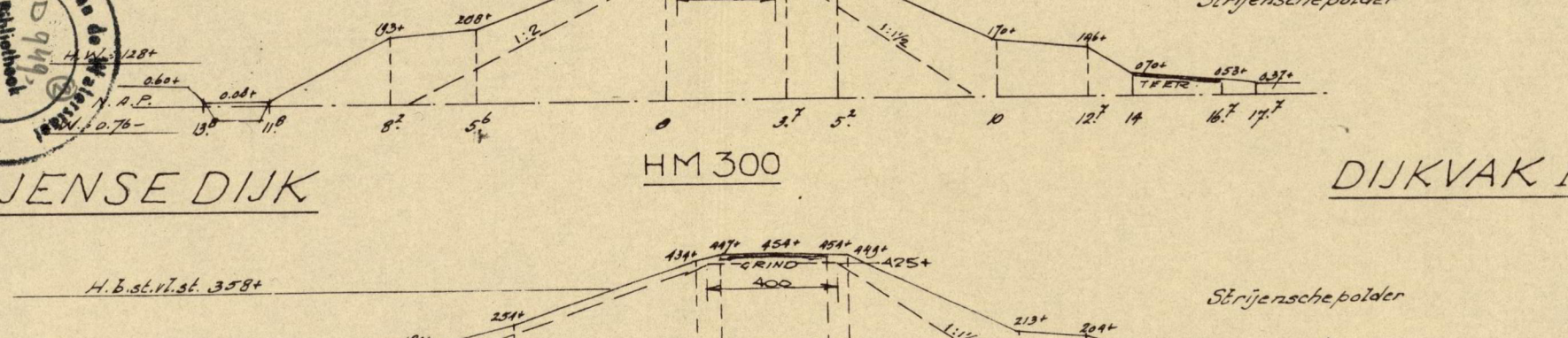
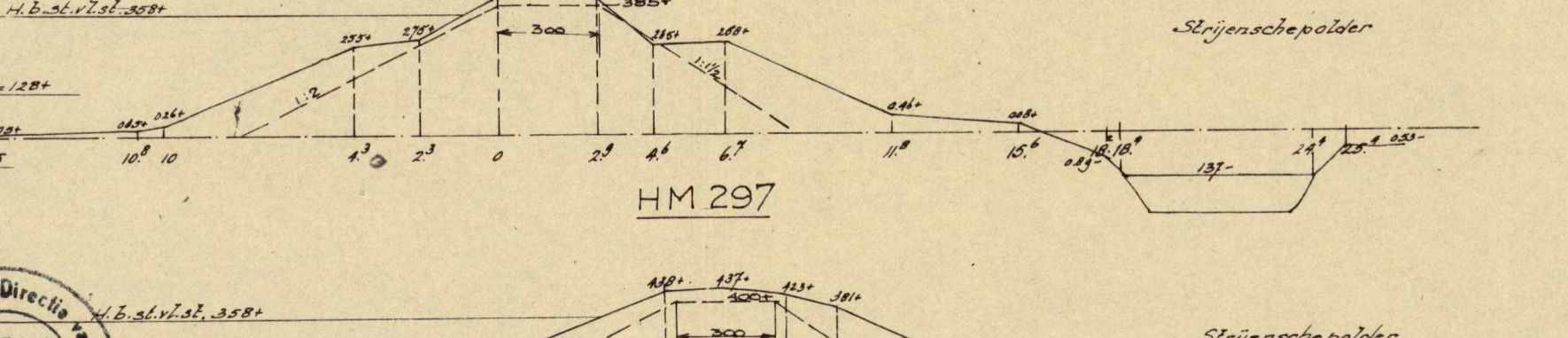
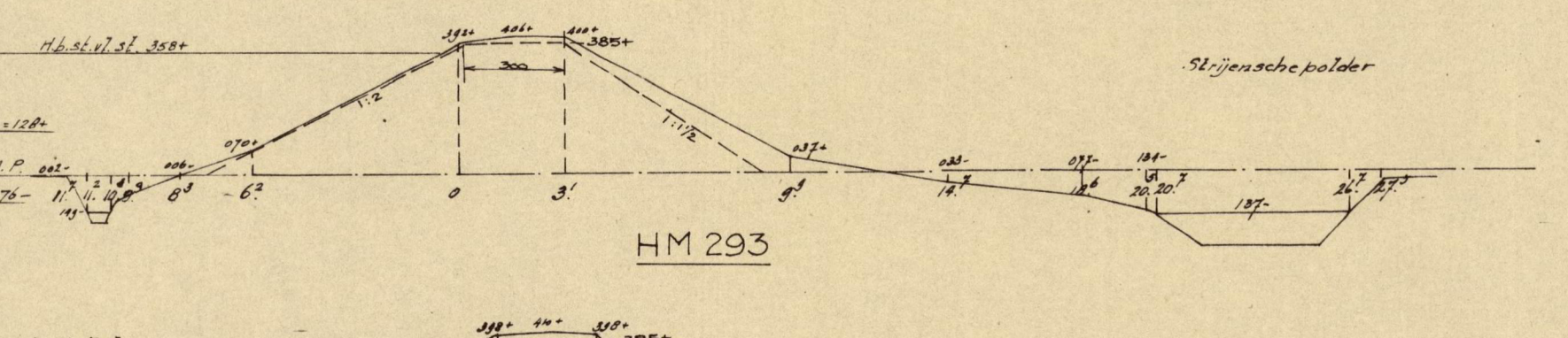
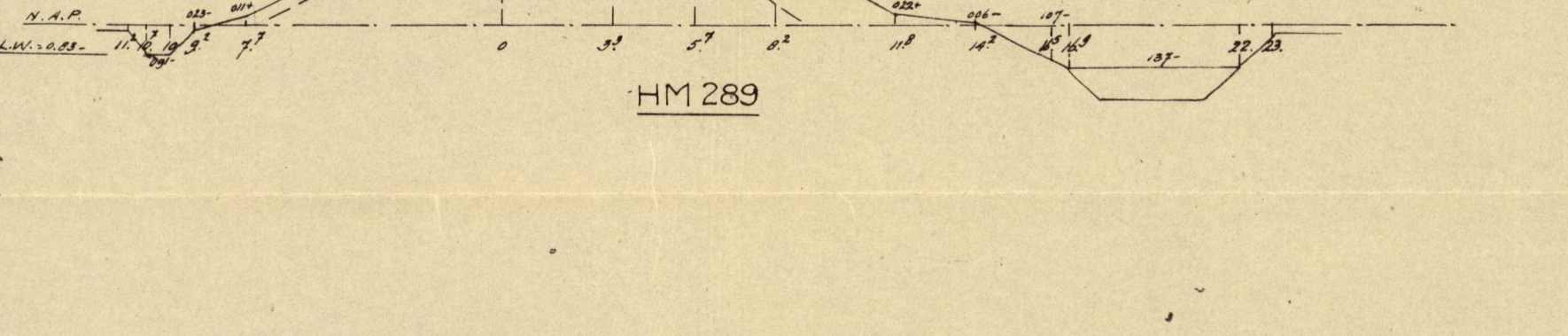
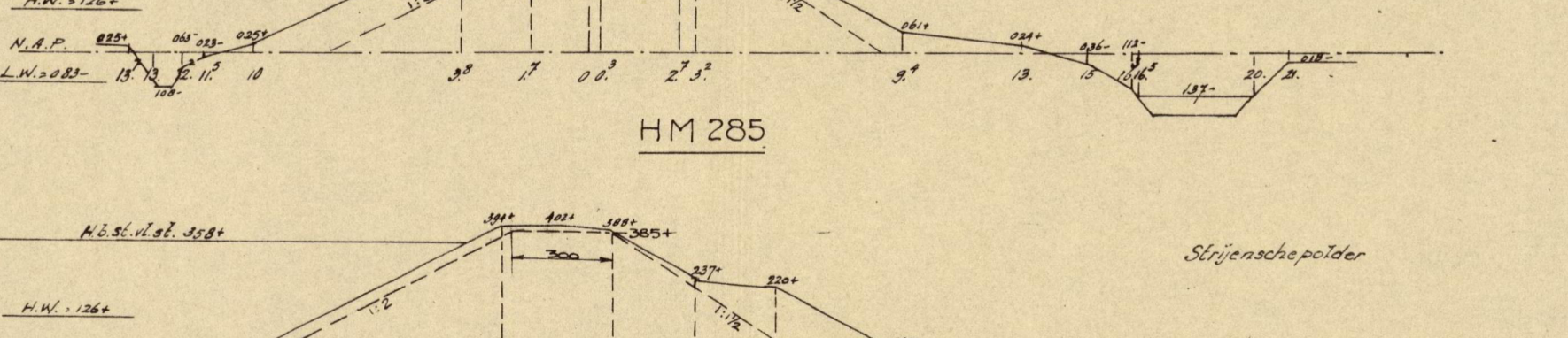

STRIJENSE DIJK

DIJKVAK 16

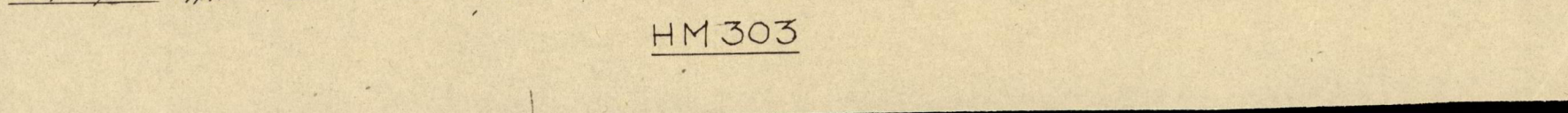

RAPPORT N° 10. 1953
BULAGE H4 BLAD 3
A4 N° 53.874
53.875

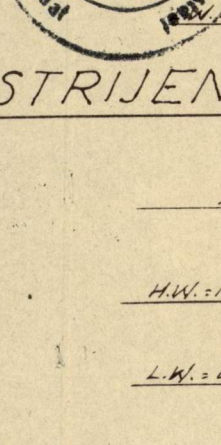

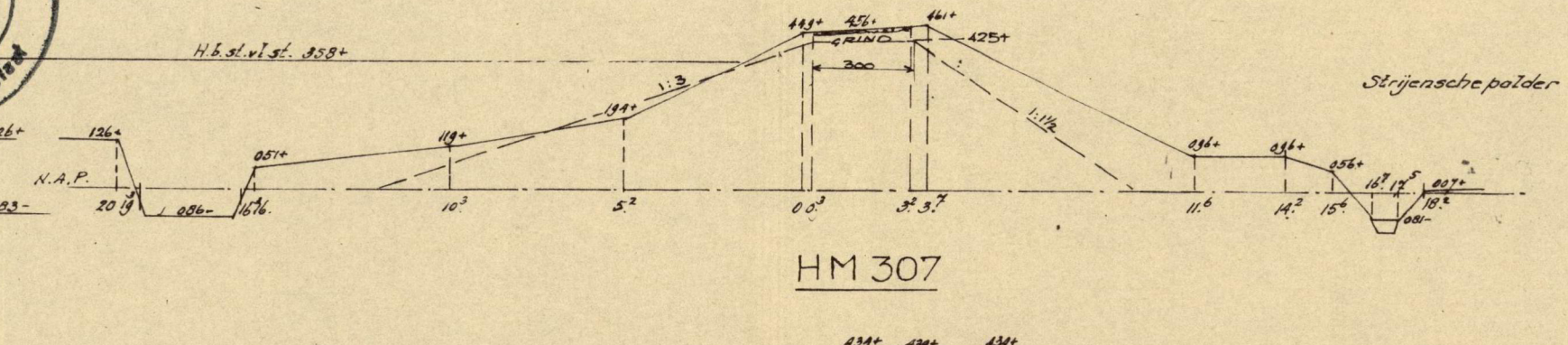
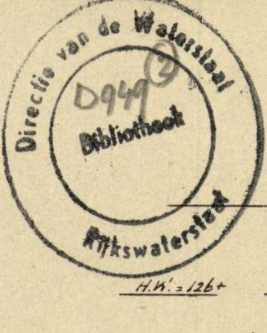

HM 307

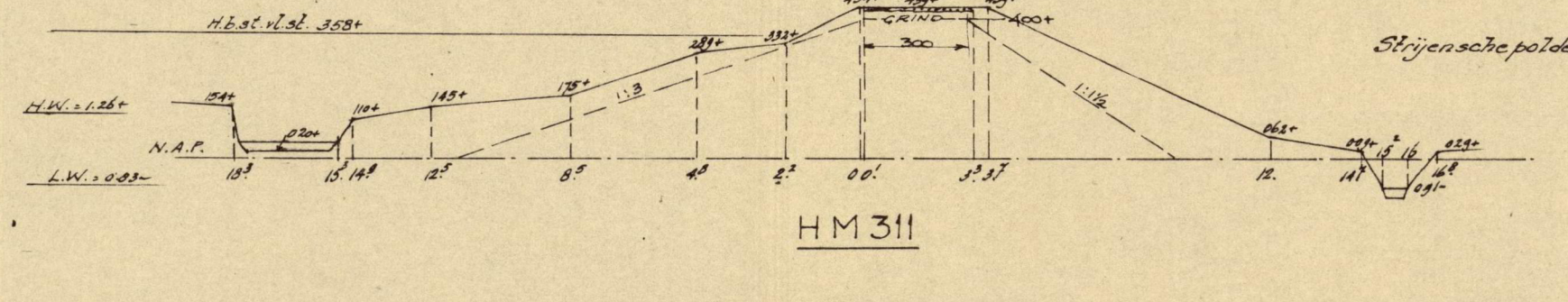

HM 311

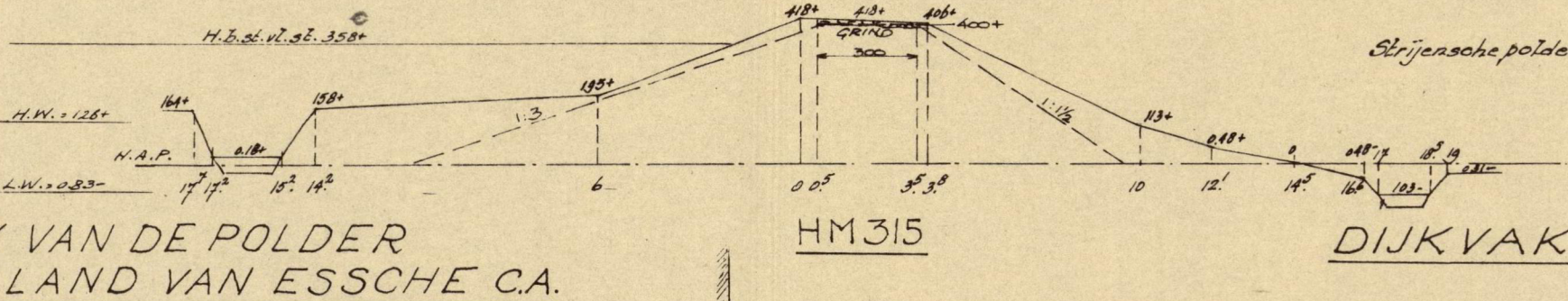

HM 315

DIJK VAN DE POLDER HET LAND VAN ESSCHE C.A.

DIJKVAK 17

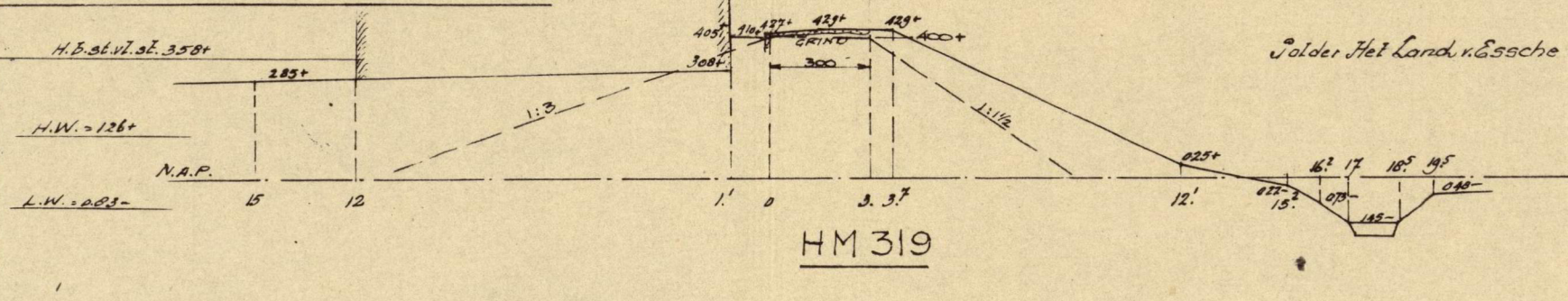

HM 319

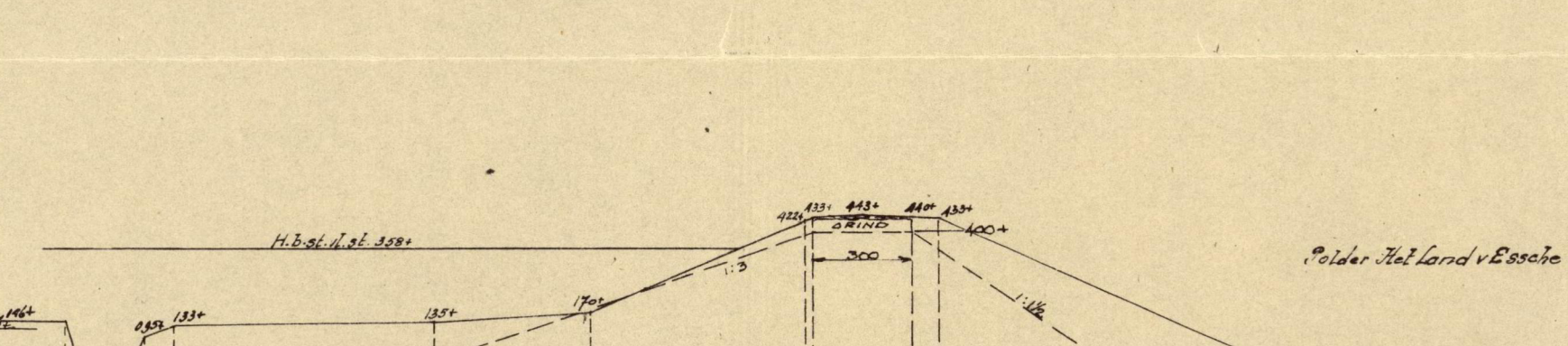

HM 324

DIJK VAN DE JOHANNAPOLDER

DIJKVAK 18

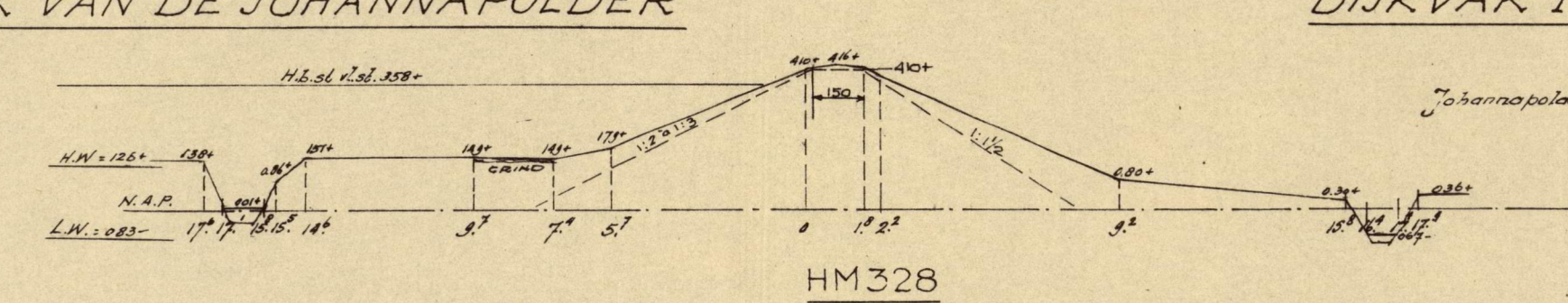

HM 328

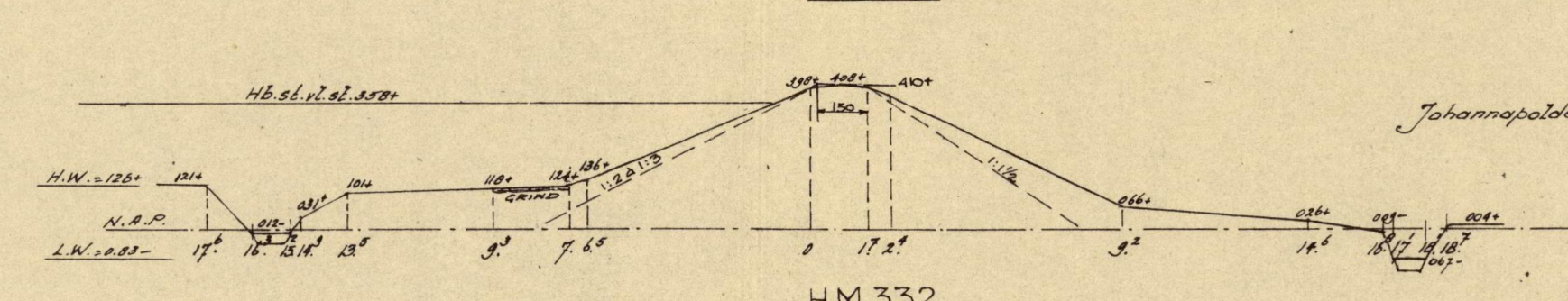

HM 332

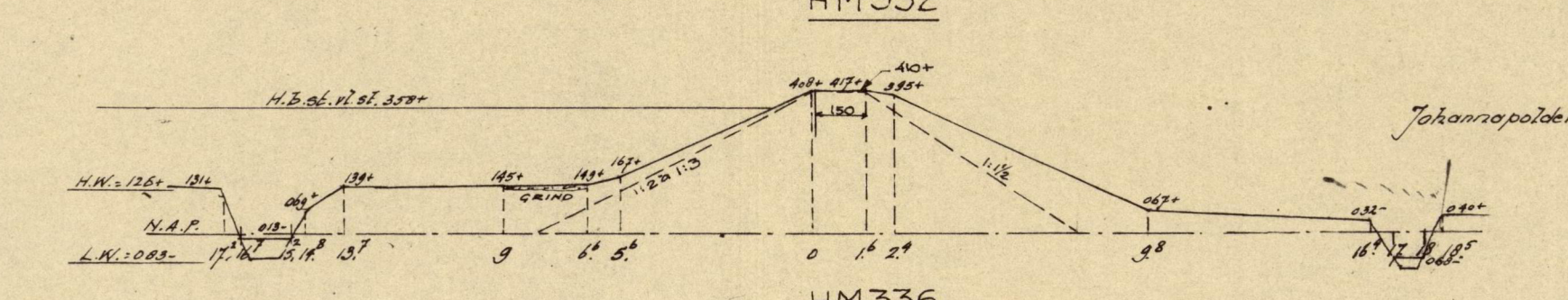

HM 336

DIJK VAN DEN NIEUWEN BEKADEN HEUVELPOLDER

DIJKVAK 19

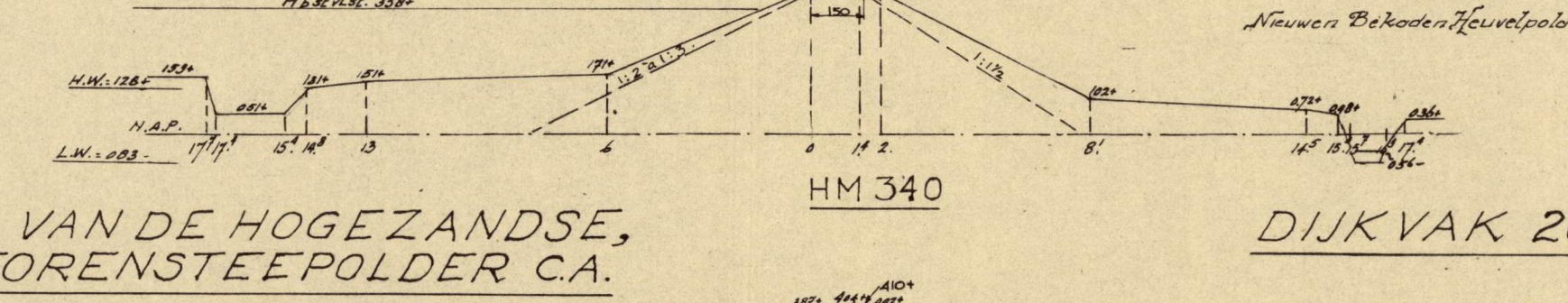

HM 340

DIJK VAN DE HOGEZANDSE, DE TORENSTEEPOLDER C.A.

DIJKVAK 20

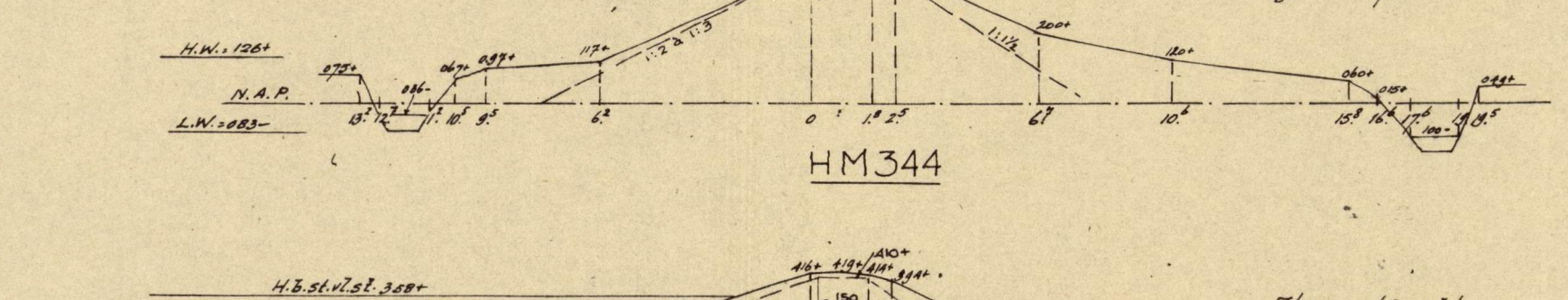

HM 344

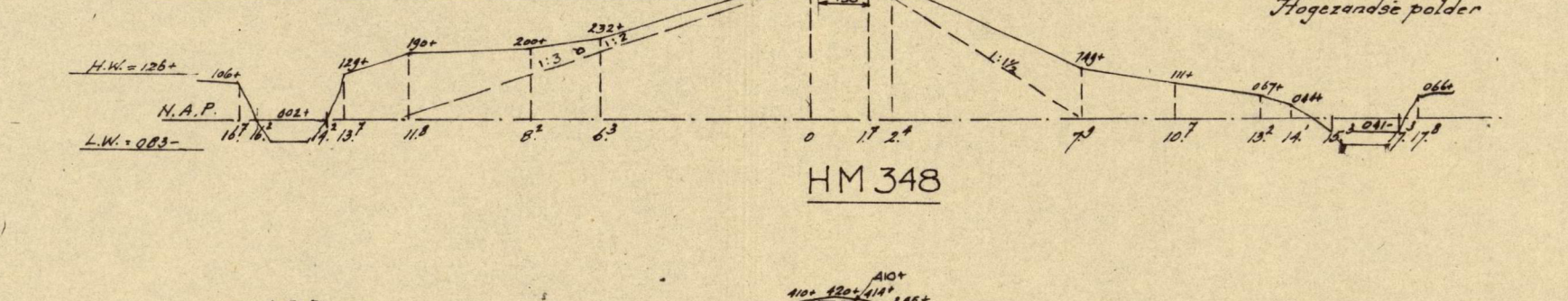

HM 348

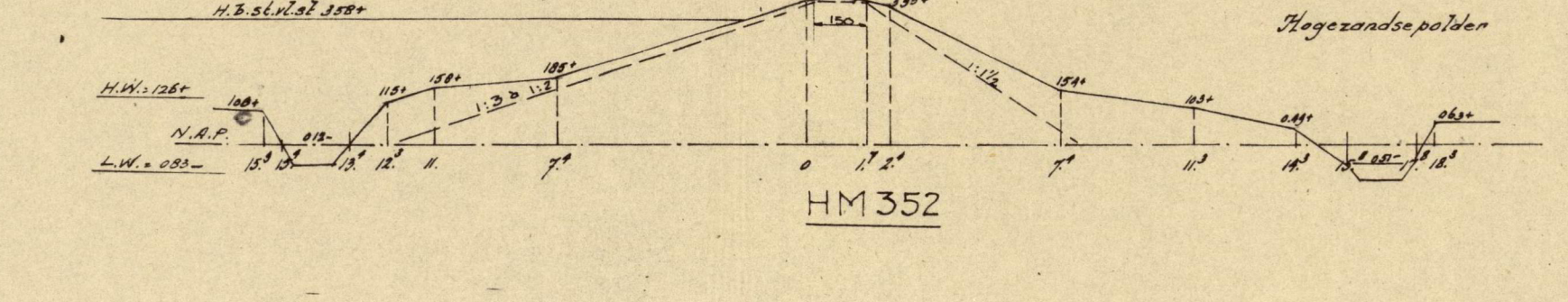

HM 352

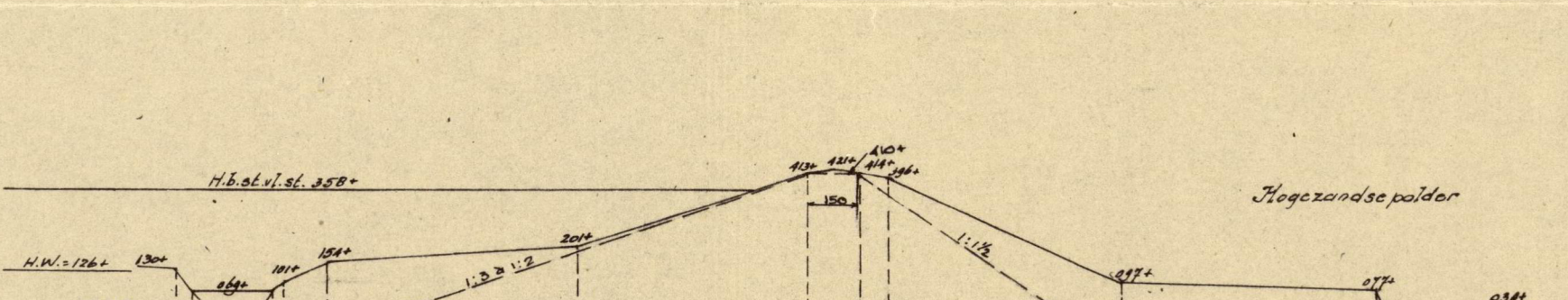

HM 356

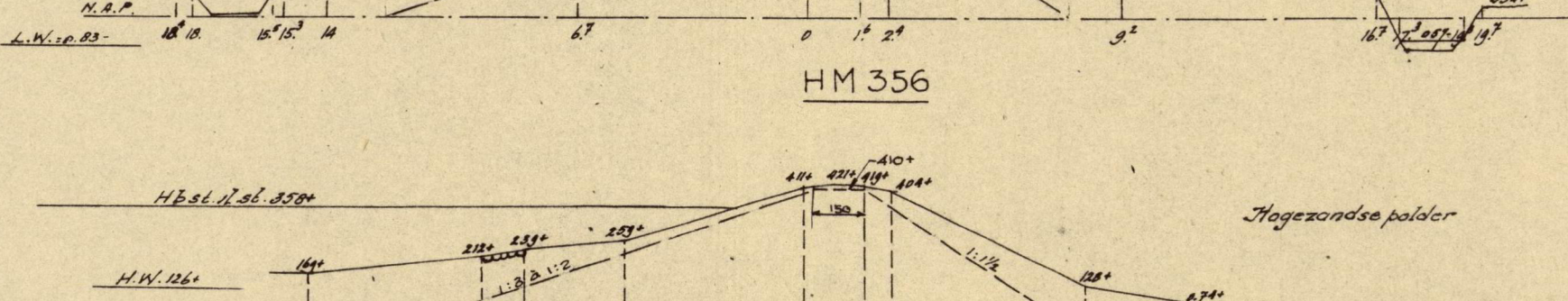

HM 360

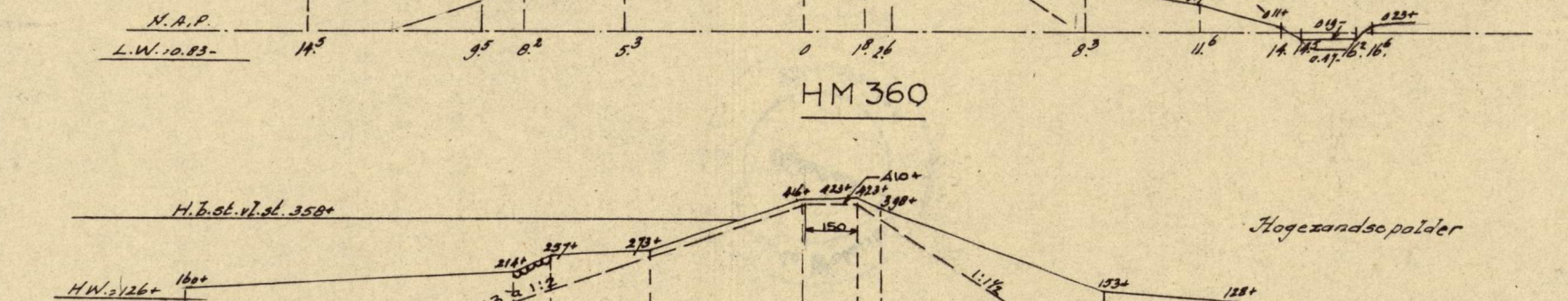

HM 364

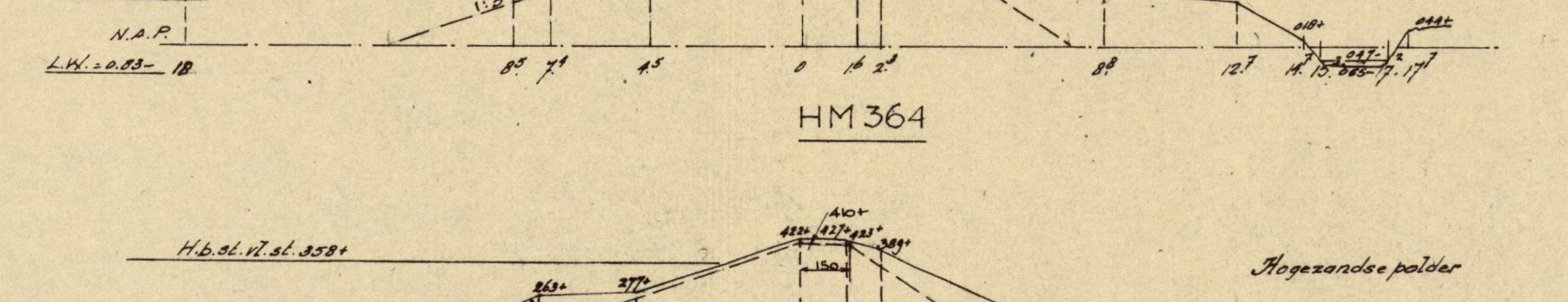

HM 368

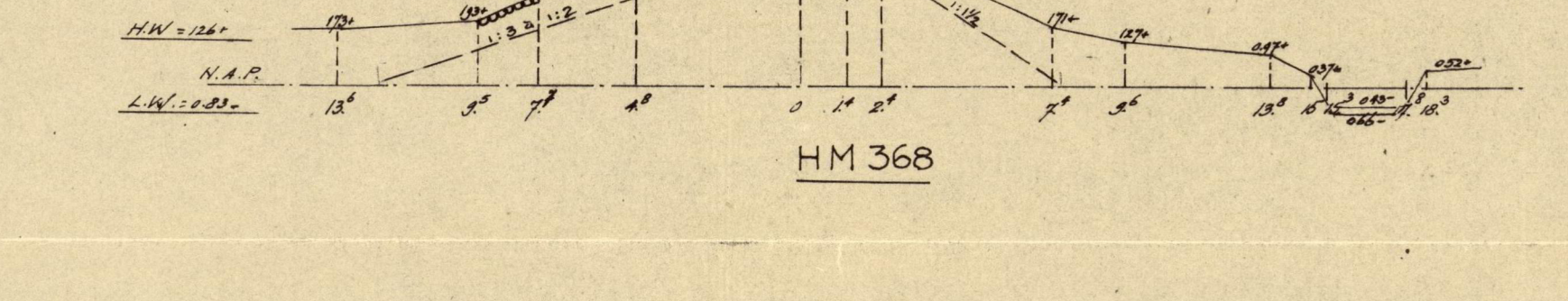

HM 372

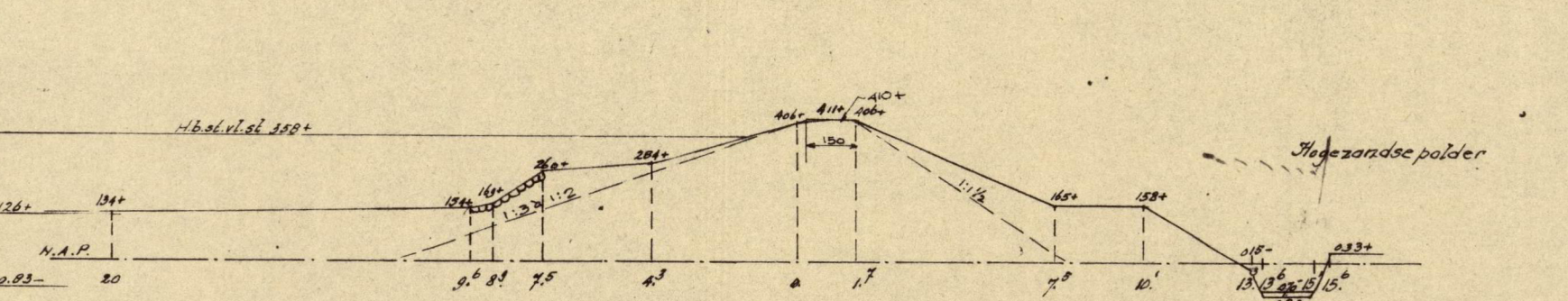

HM 376

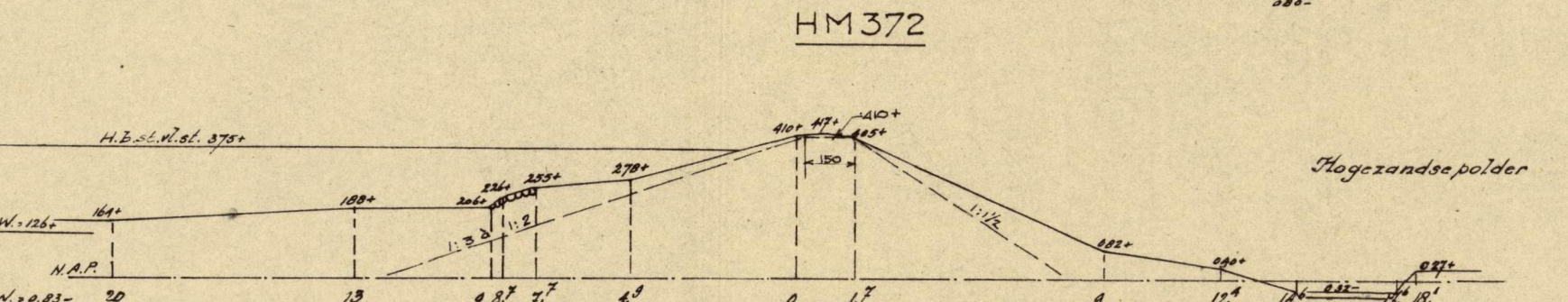

HM 380

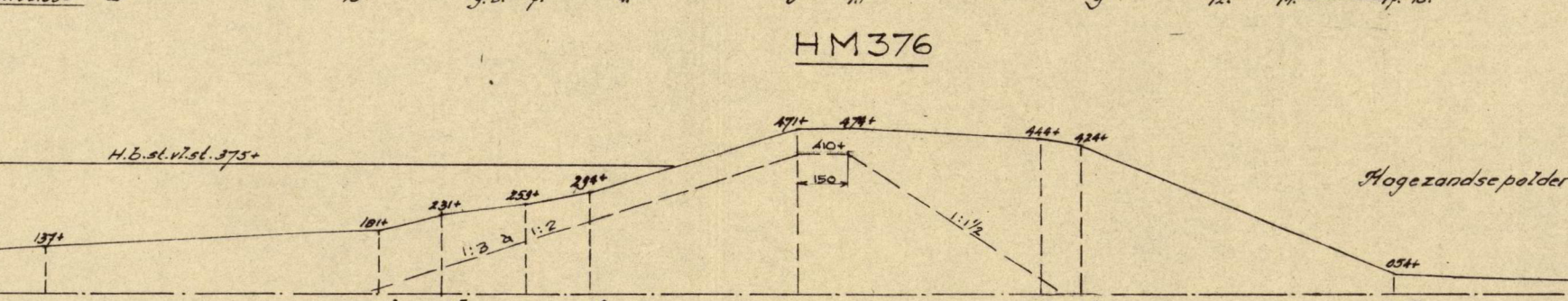

HM 382

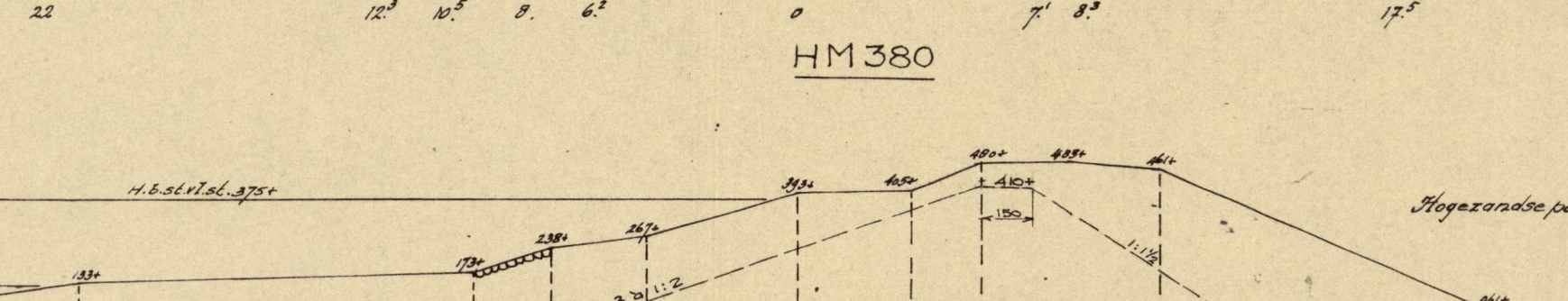

HM 389

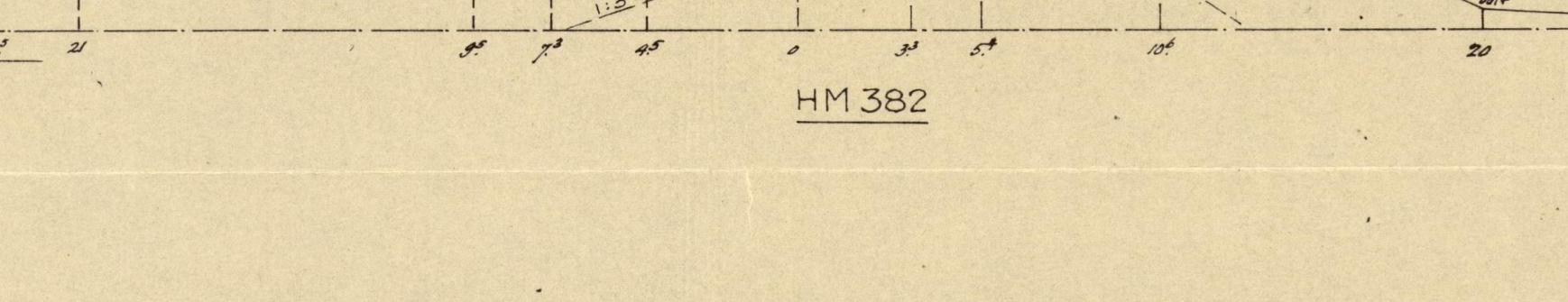

HM 393

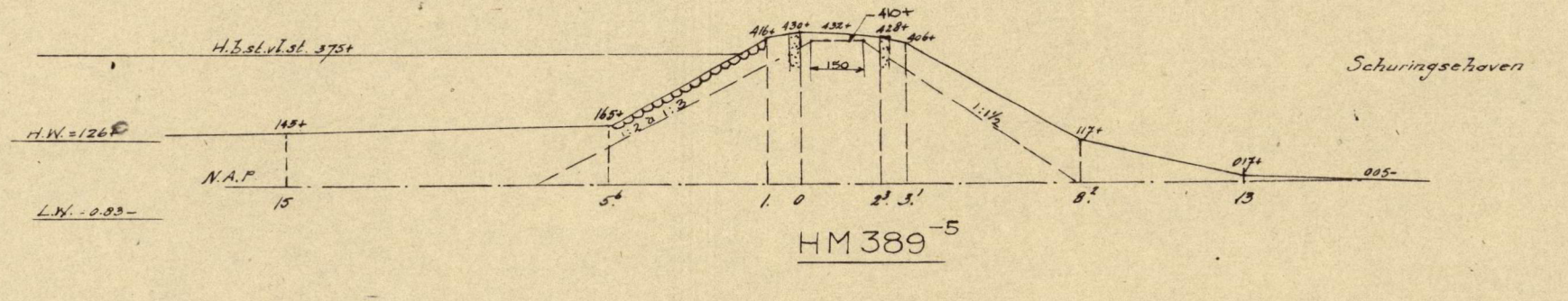

HM 397

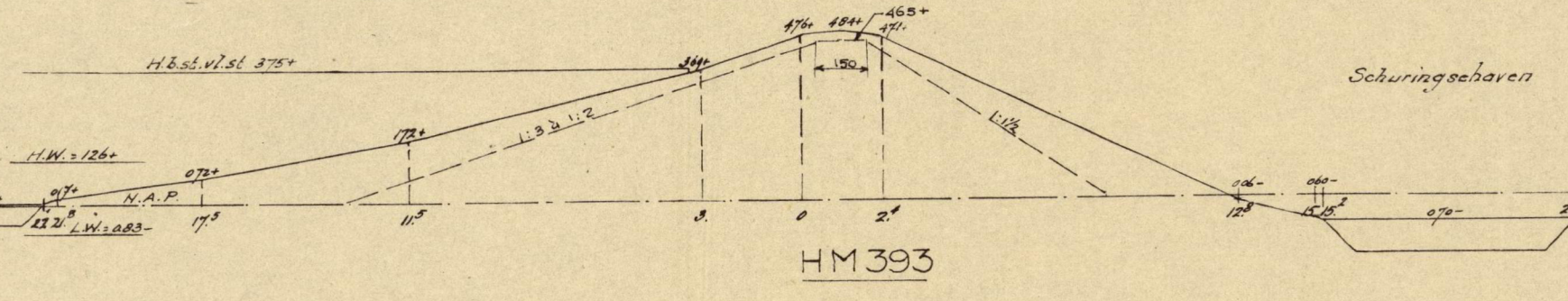

HM 401

RAPPORT NR 10. 1953

BULAGE H4 BLAD 4 A6 NR. 53. 876

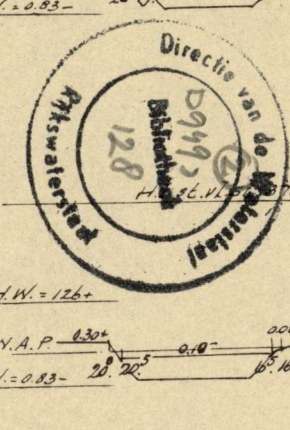

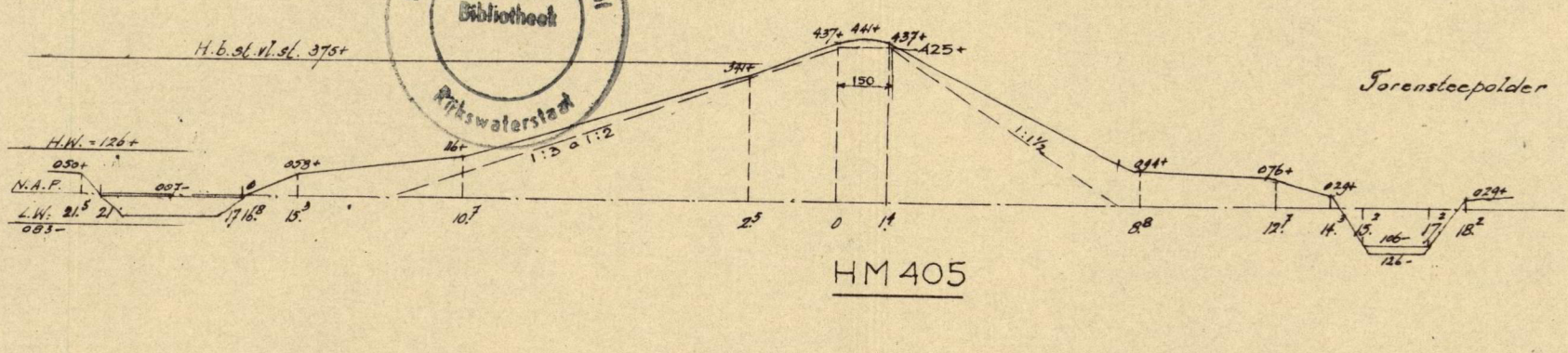

HM 405

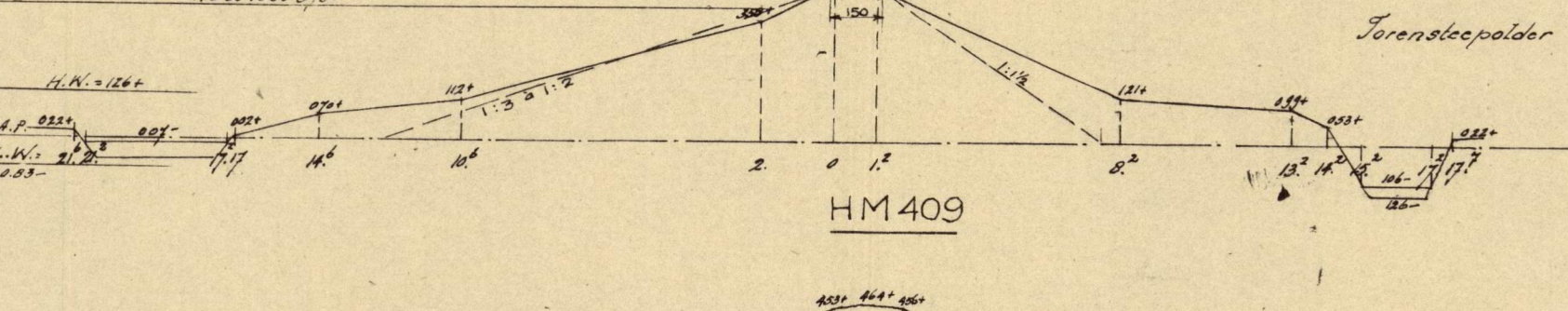

HM 409



HM 413



HM 417

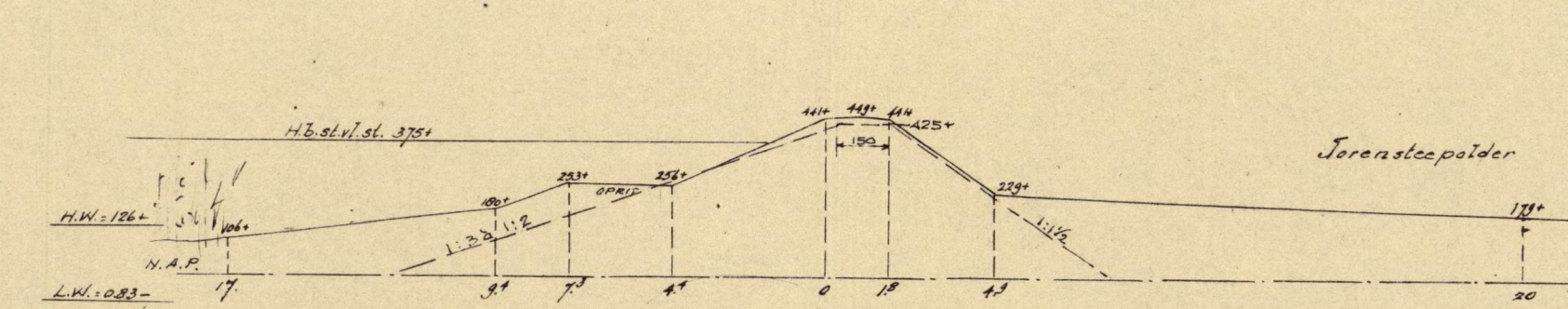

HM 421

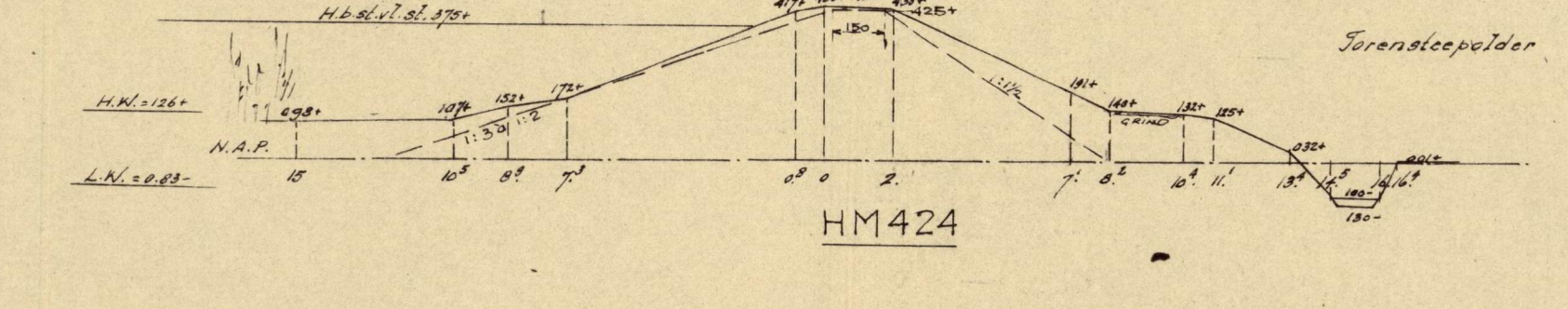

HM 424

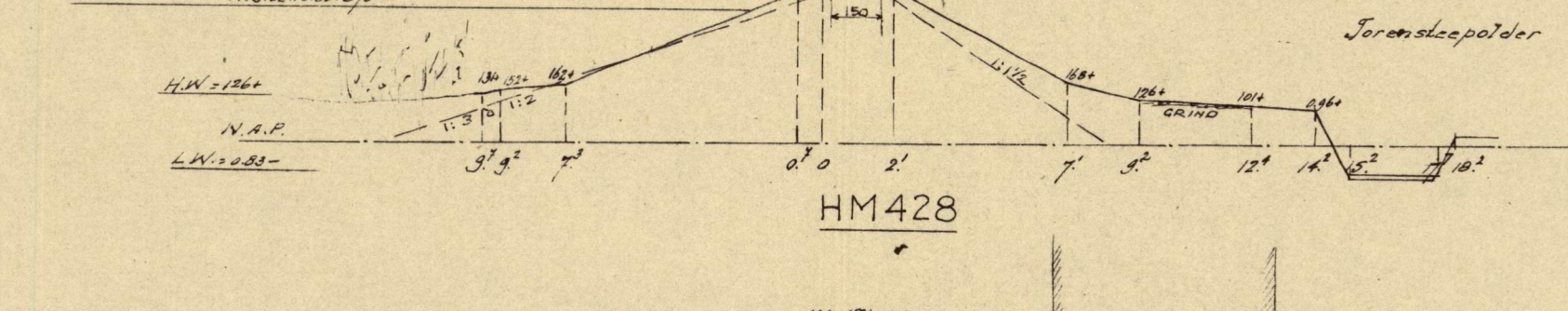

HM 428

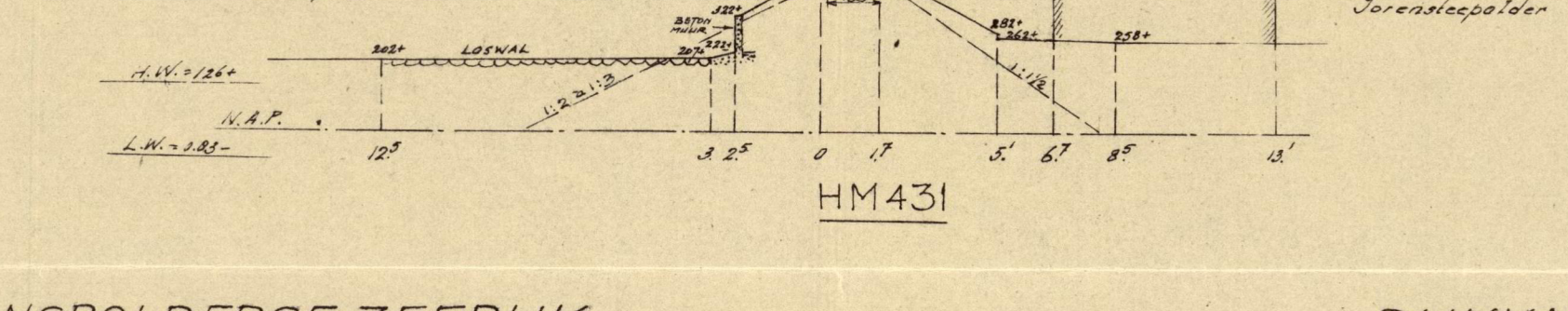

HM 431

NUMANSPOLDERSE ZEEDIJK

DIJKVAK 21.



HM 435



HM 439



HM 443



HM 447

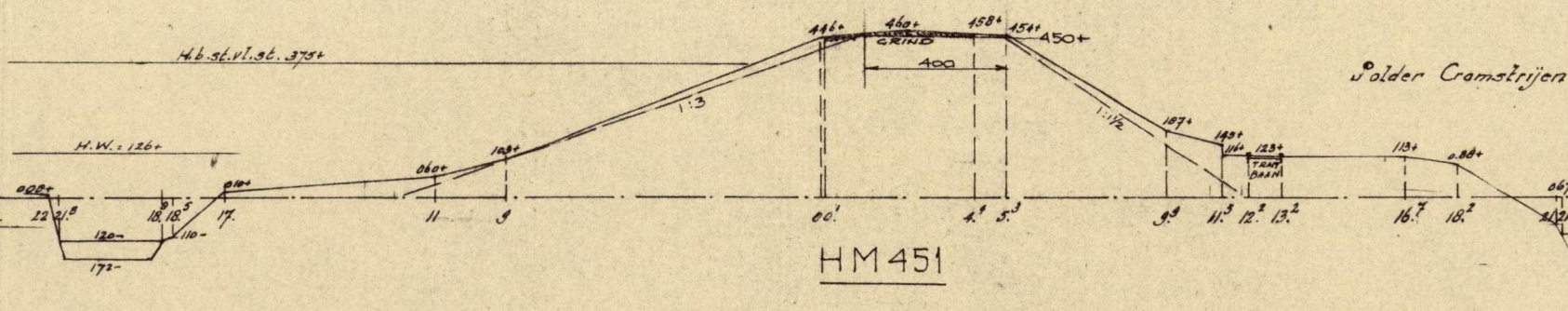

HM 451

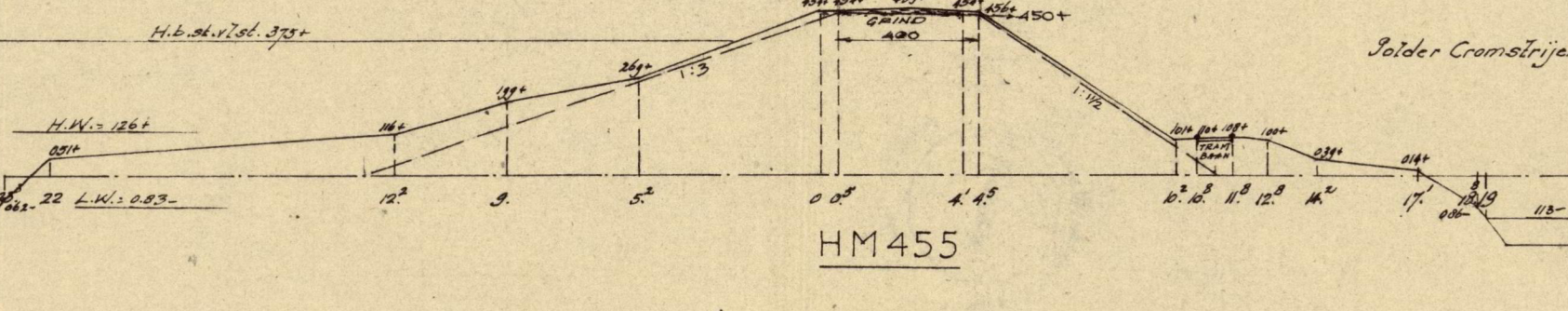

HM 455

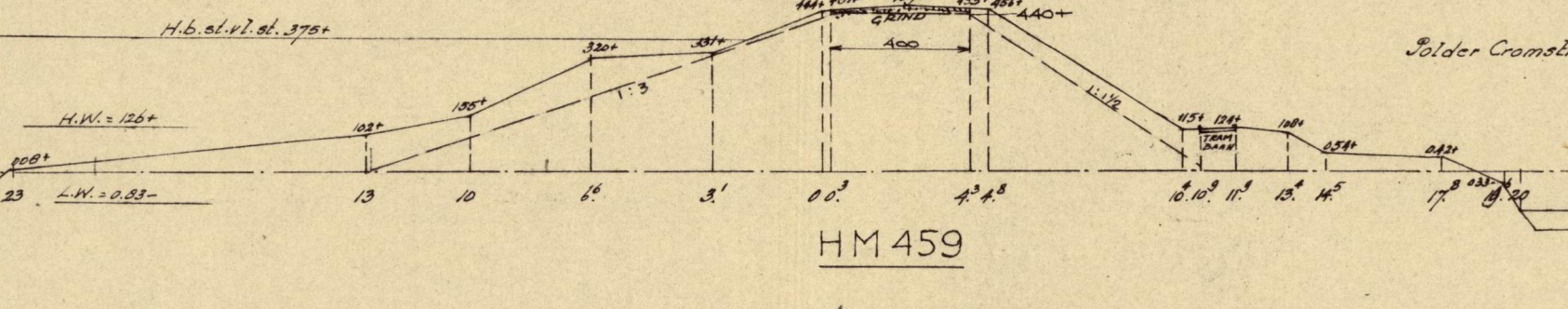

HM 459

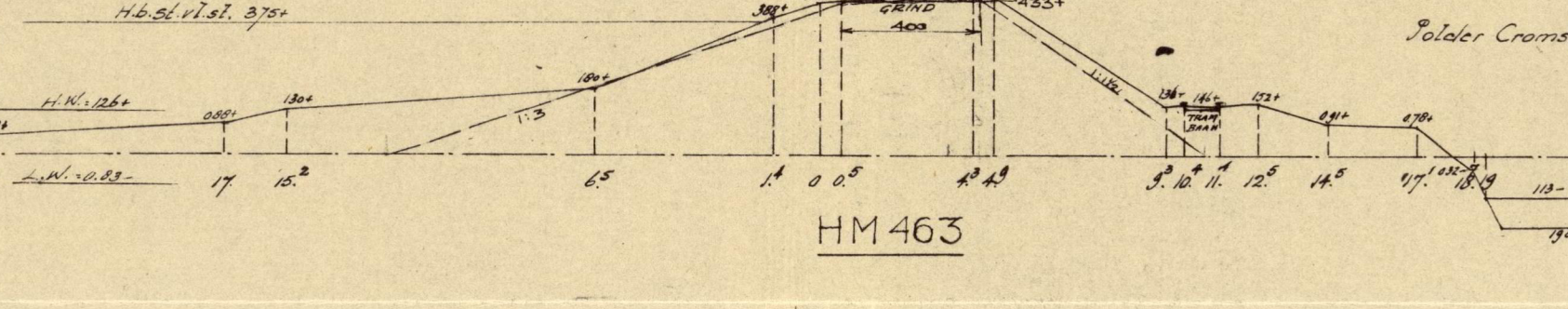

HM 463

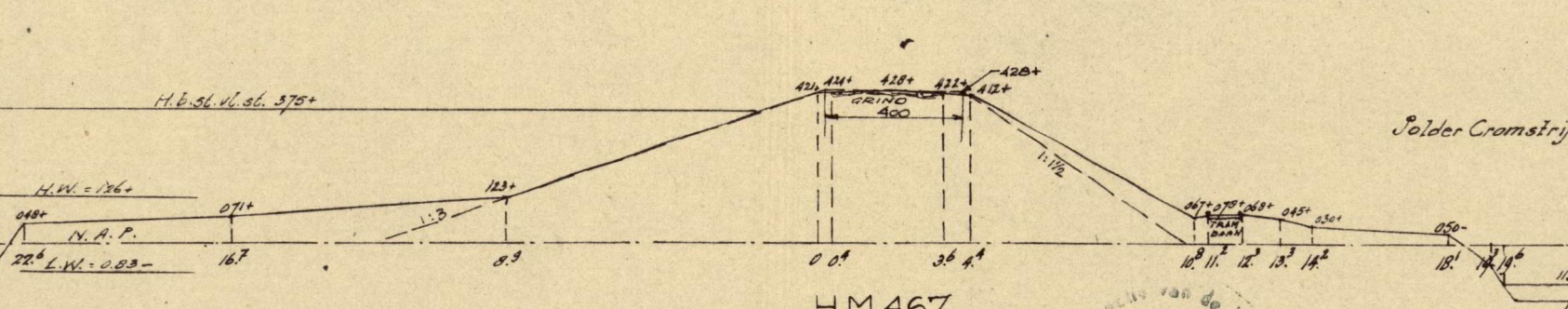

HM 467

SCHENKELDIJK 1/2 EENDRAGTSPOLDER

DIJKVAK 22

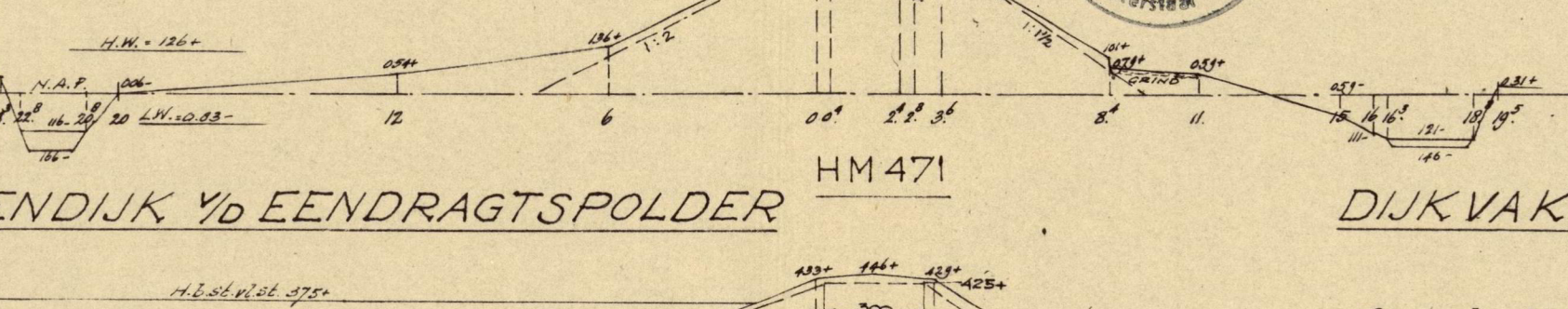

HM 471

BUITENDIJK 1/2 EENDRAGTSPOLDER

DIJKVAK 23



HM 475

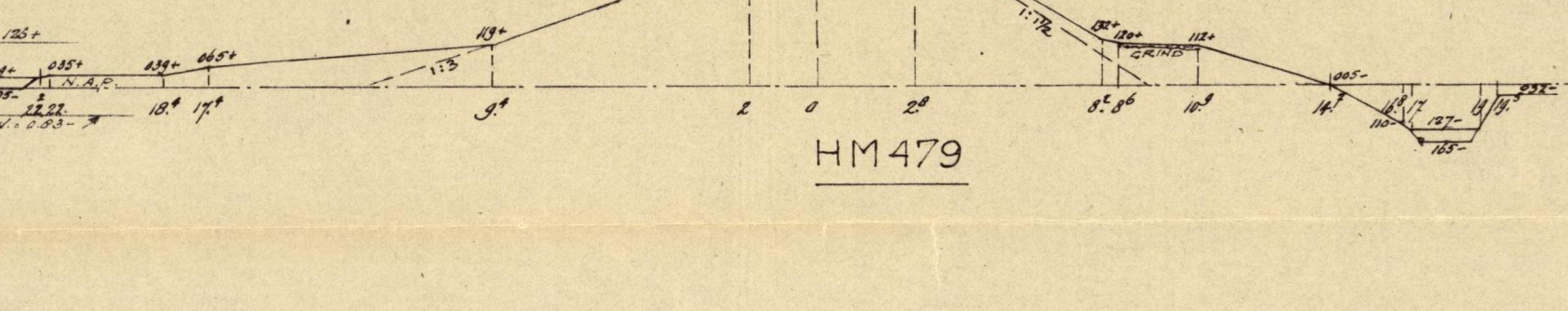

HM 479

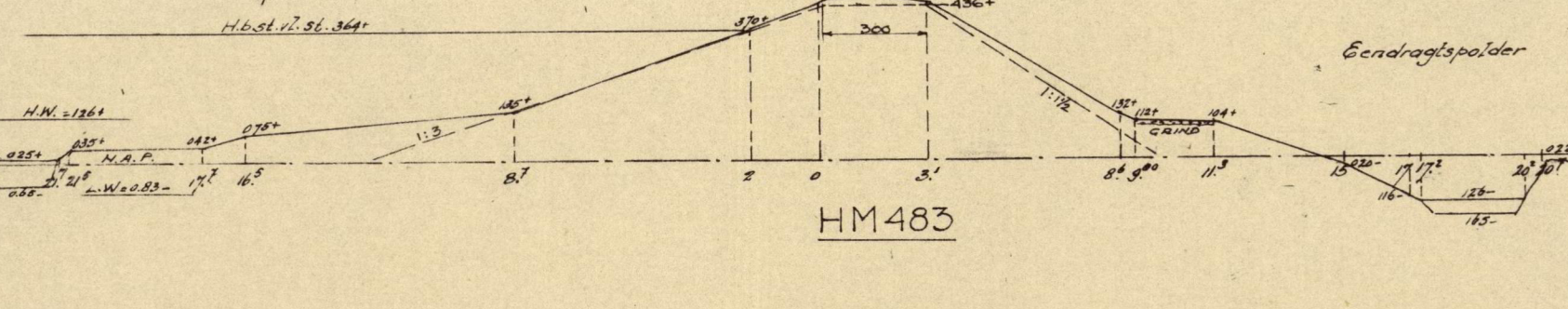

HM 483

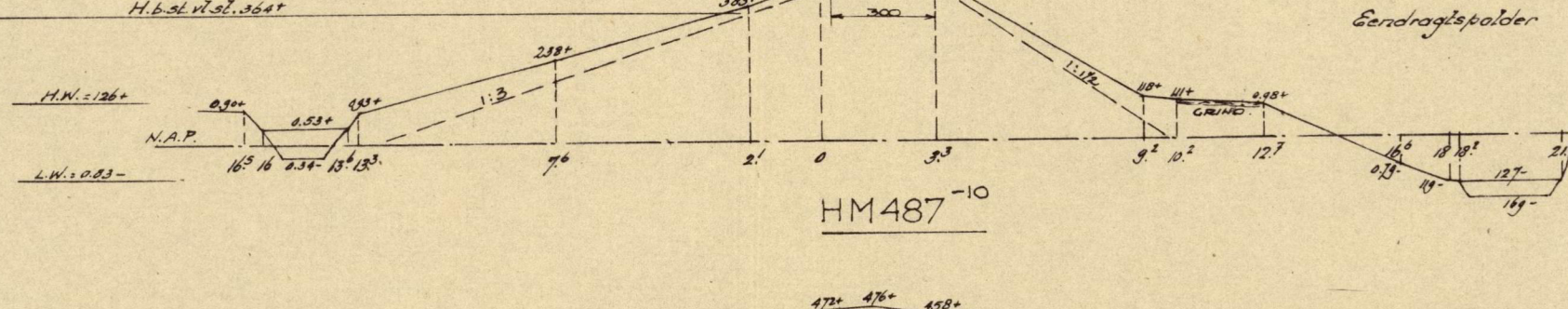

HM 487

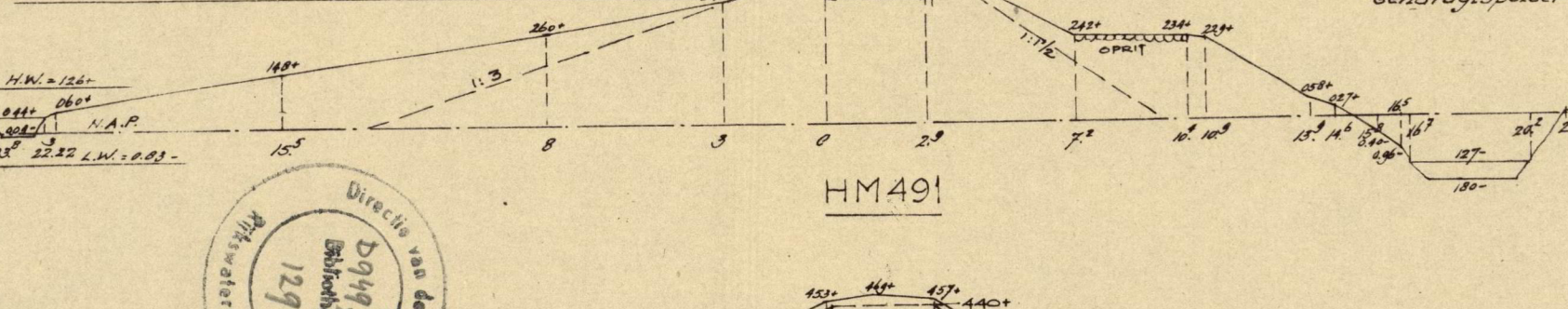

HM 491



HM 495

RAAPPORT Nr 10. 1953

BULAGE H4 BLAD 5 A6 Nr. 53.877

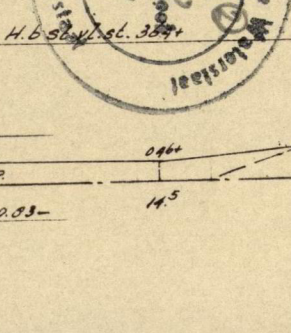

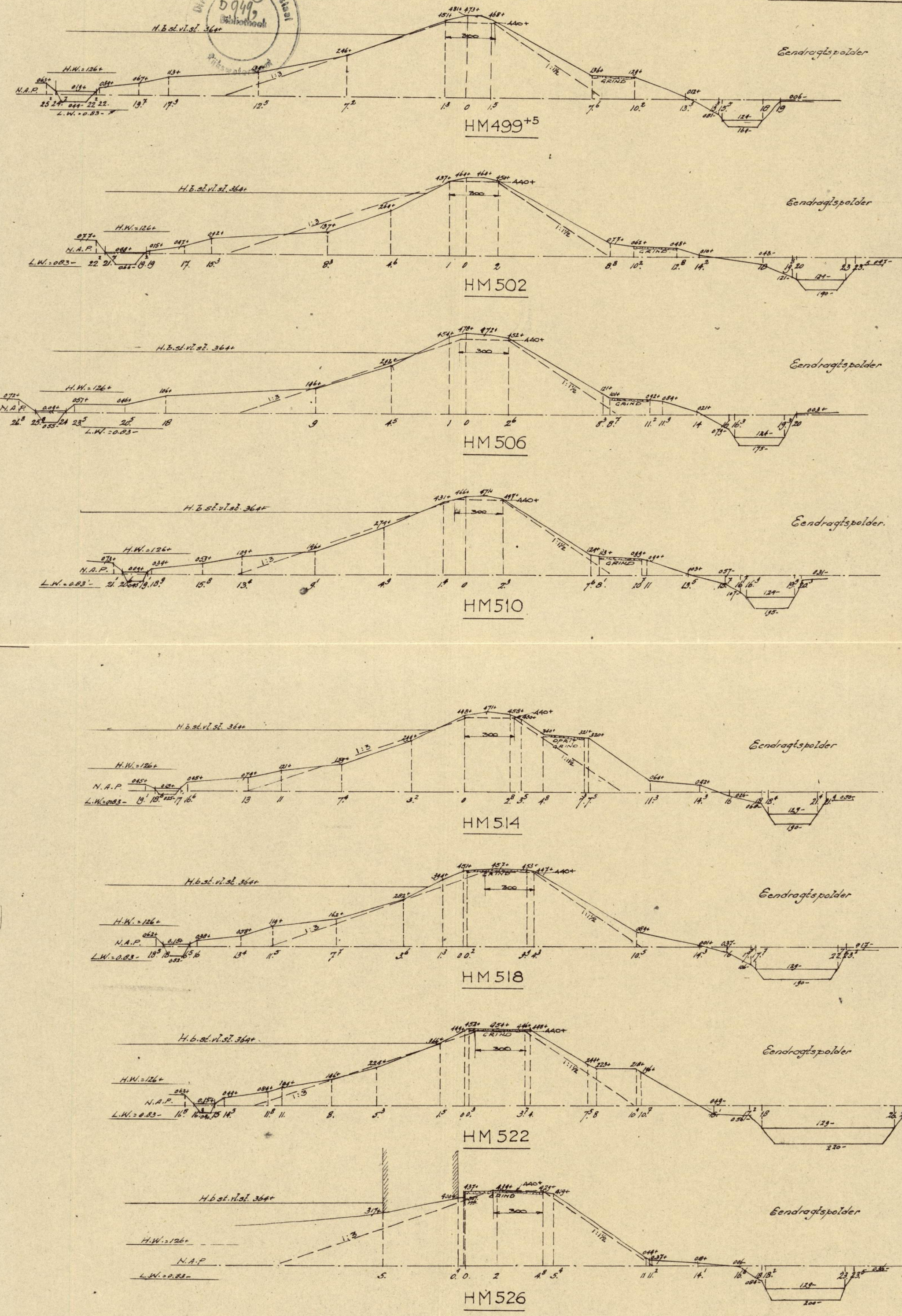

NIEUWENDIJK VAN DE EENDRAGTSPOLDER

DIJKVAK 24

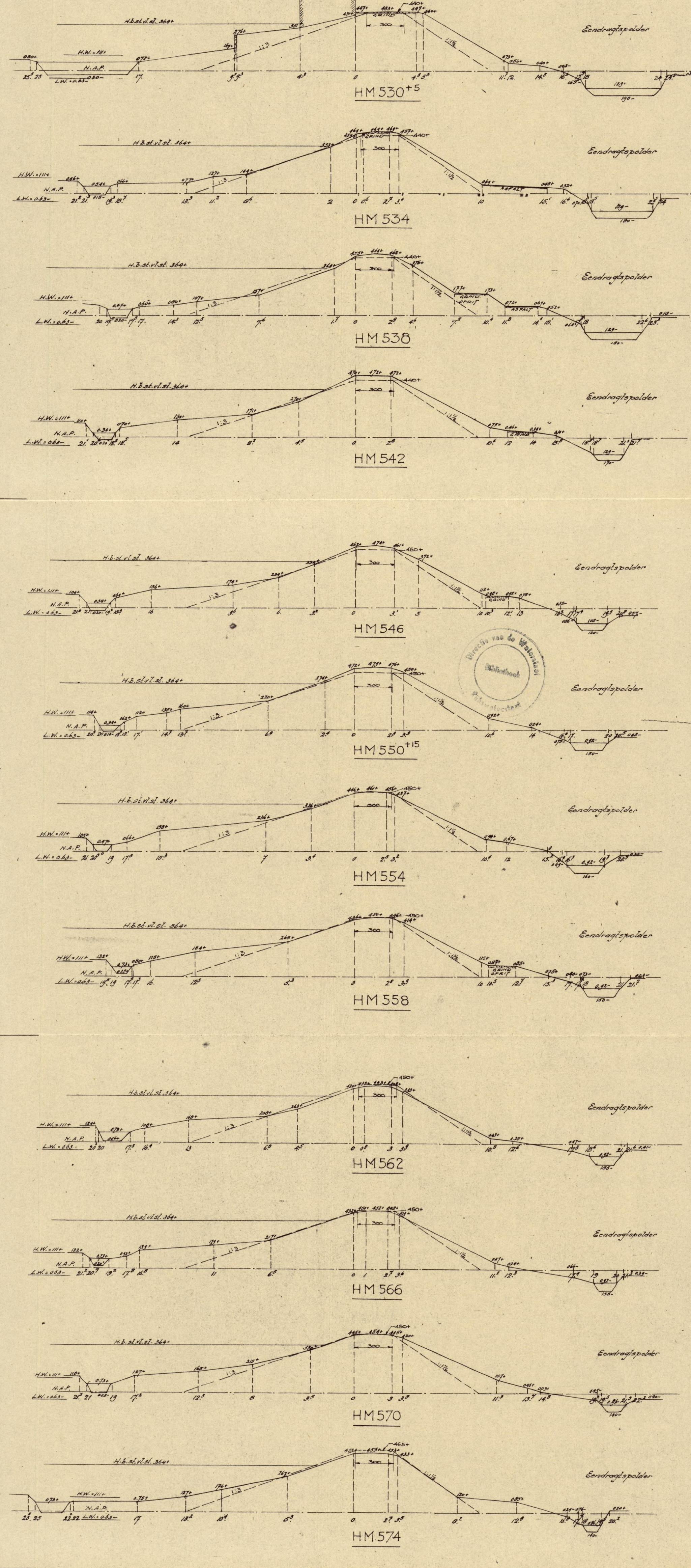

OUDENDIJK C.A.

DIJKVAK 25

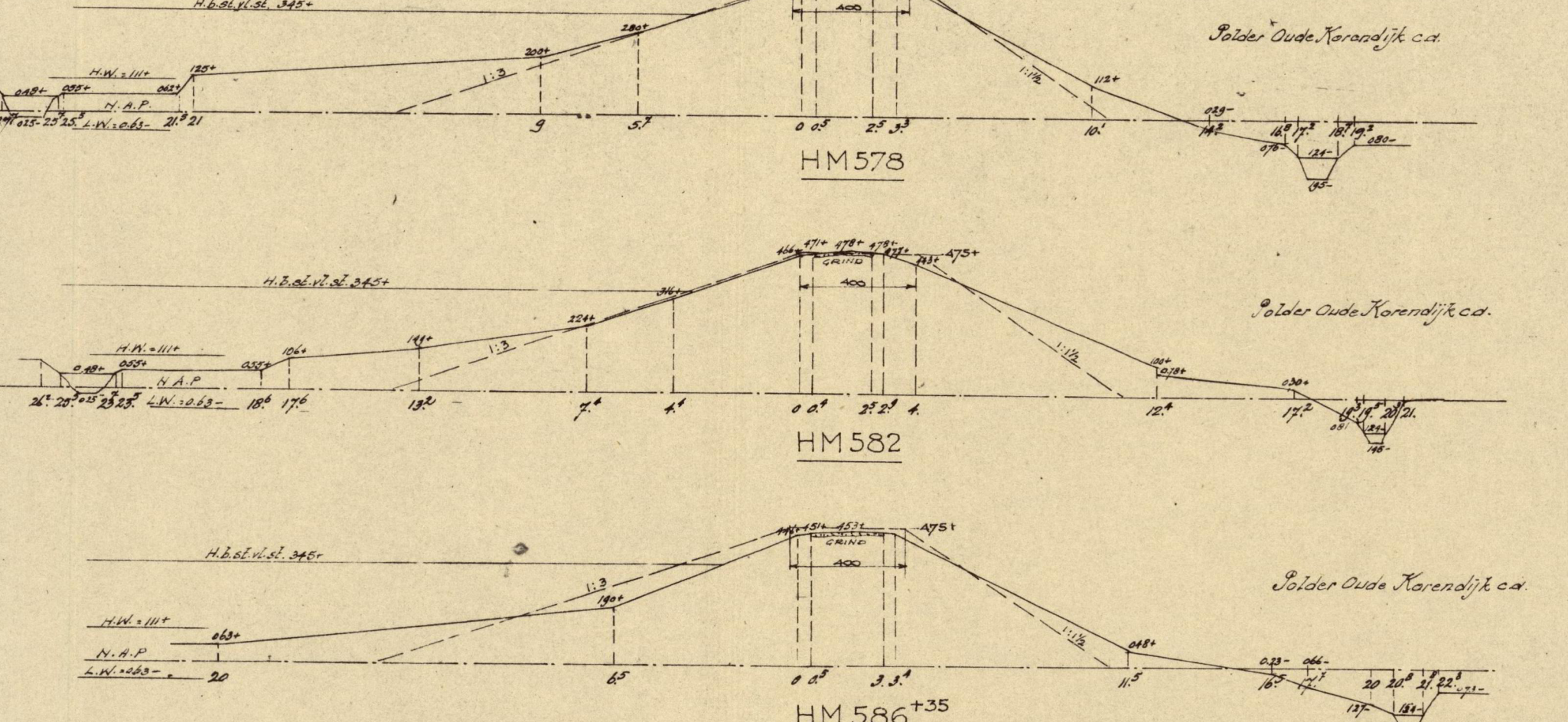

WEST-OF HOLLAARSDIJK

DIJKVAK 26

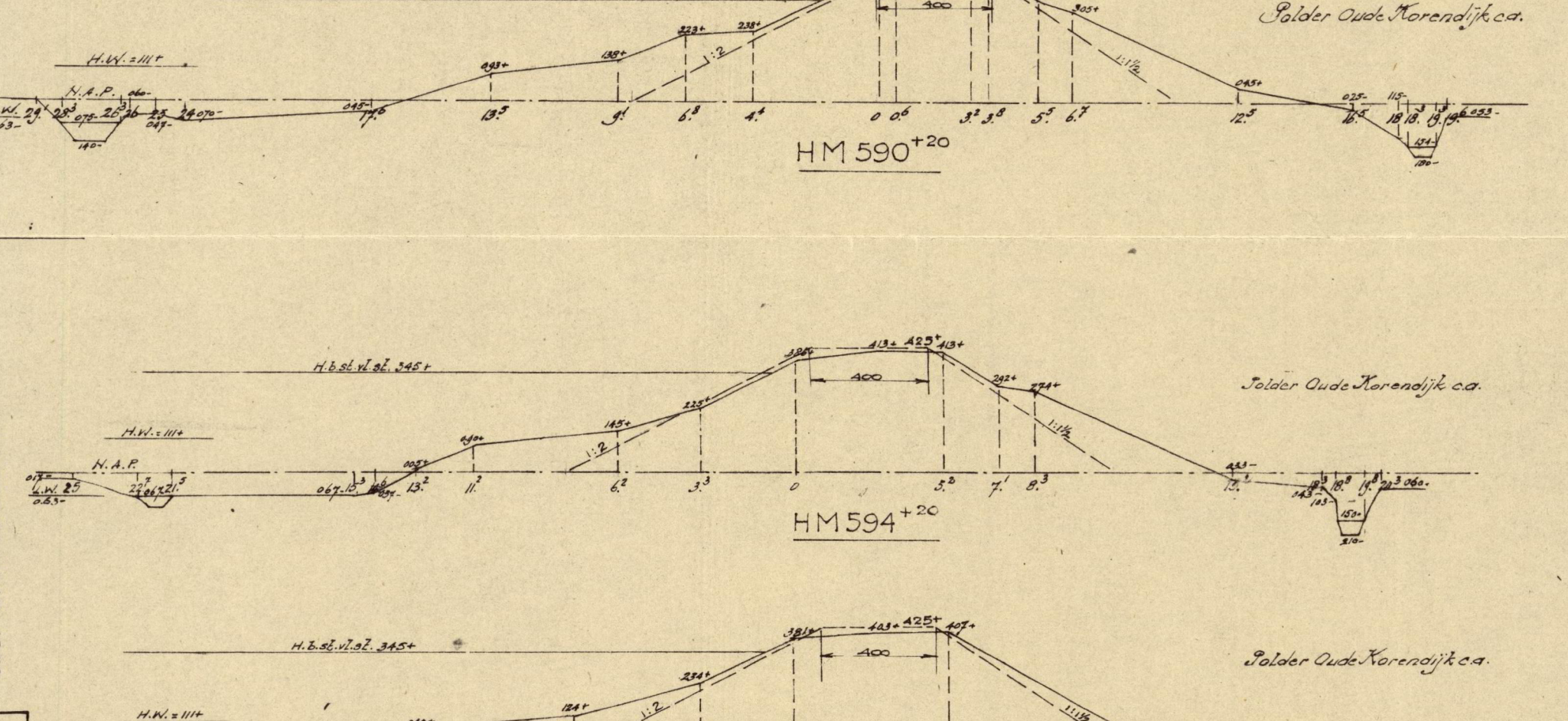

DWARSDIJK 1/6 POLDER OUDE KORENDIJK C.A.

DIJKVAK 27

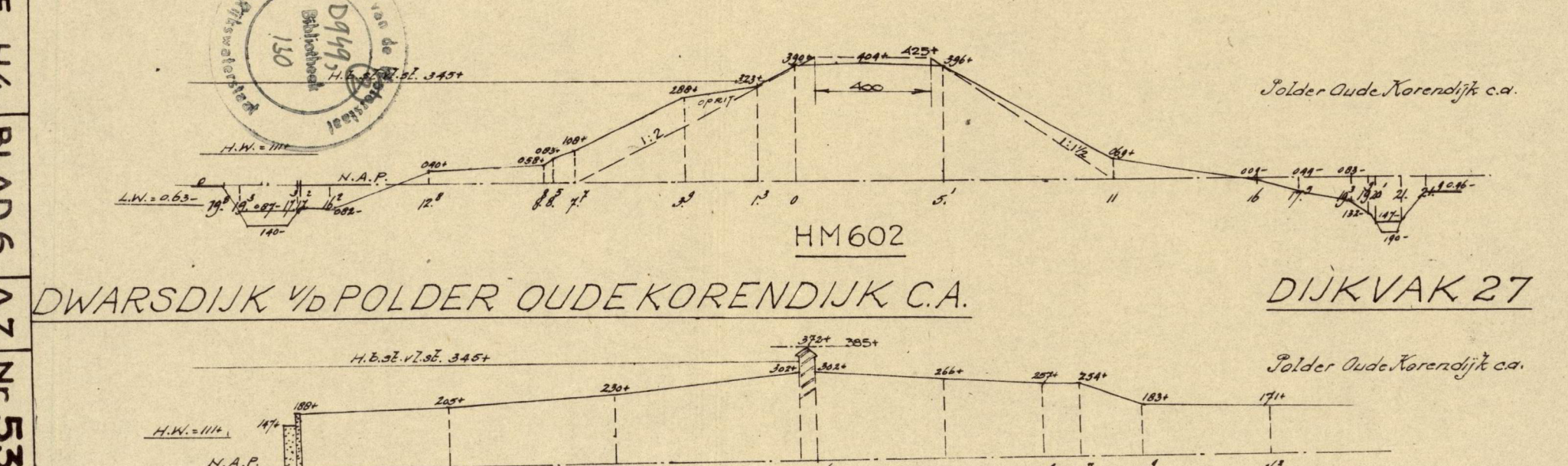

RAPPORT No. 10. 1953
BULAGE H4
BLAD 6
A7 Nr. 53.878

SPUIDIJK

DIJKVAK 28

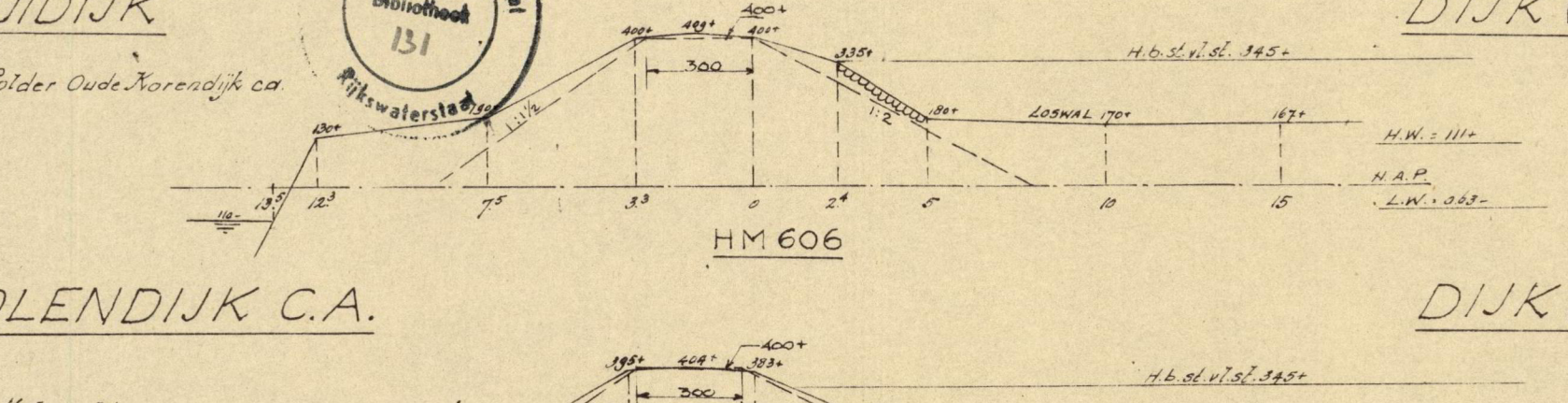
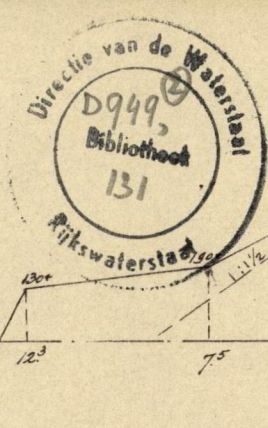

MOLENDIJK C.A.

DIJKVAK 29

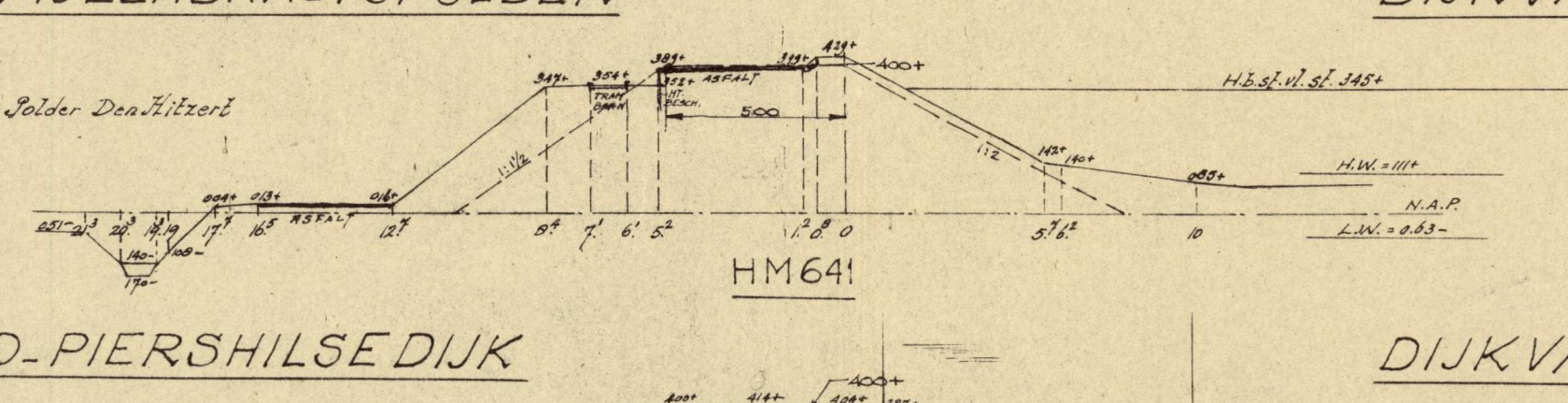
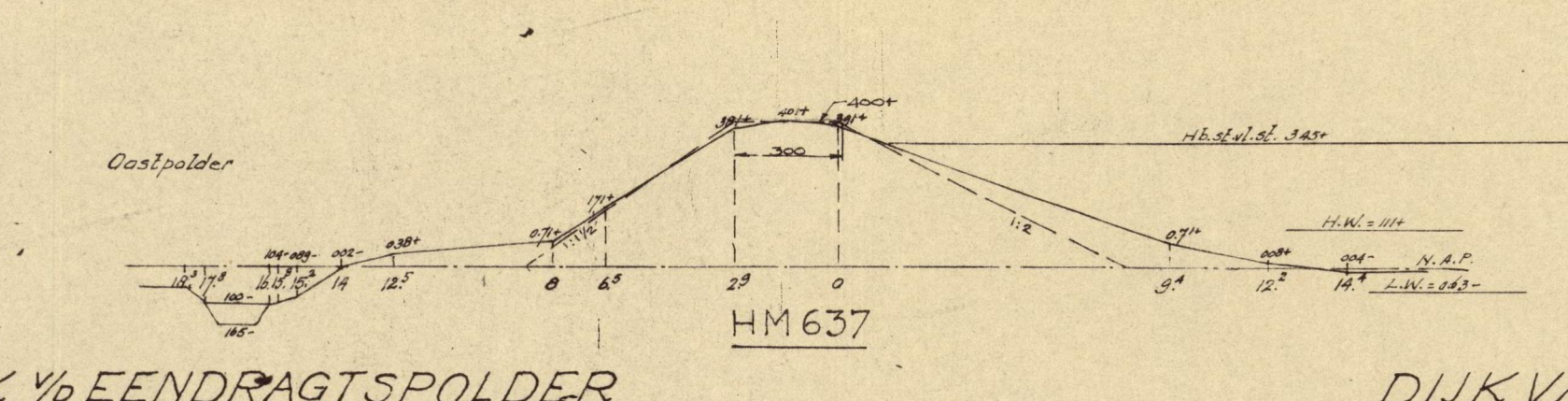
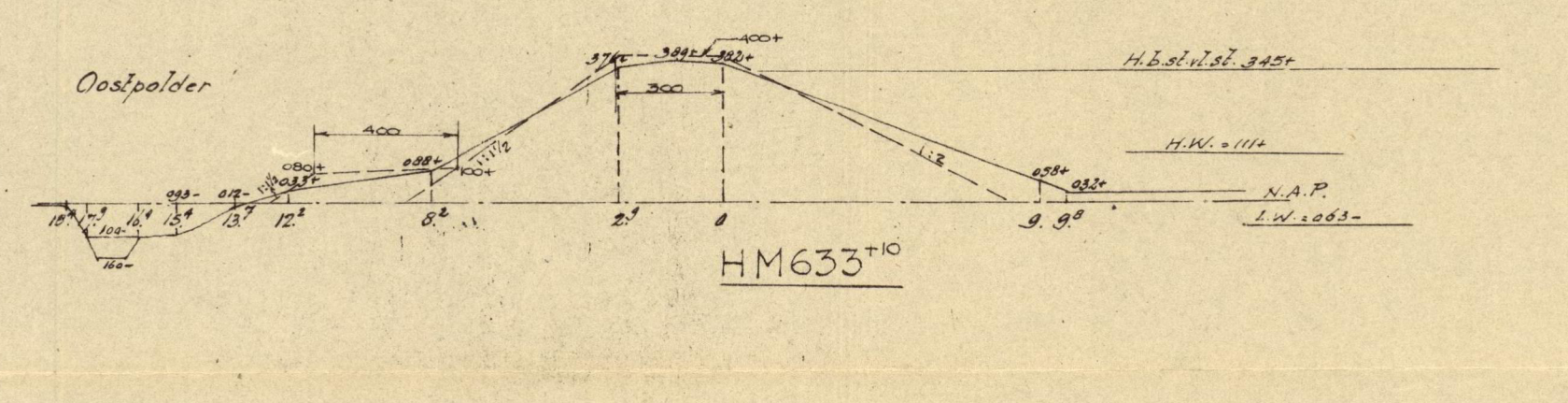
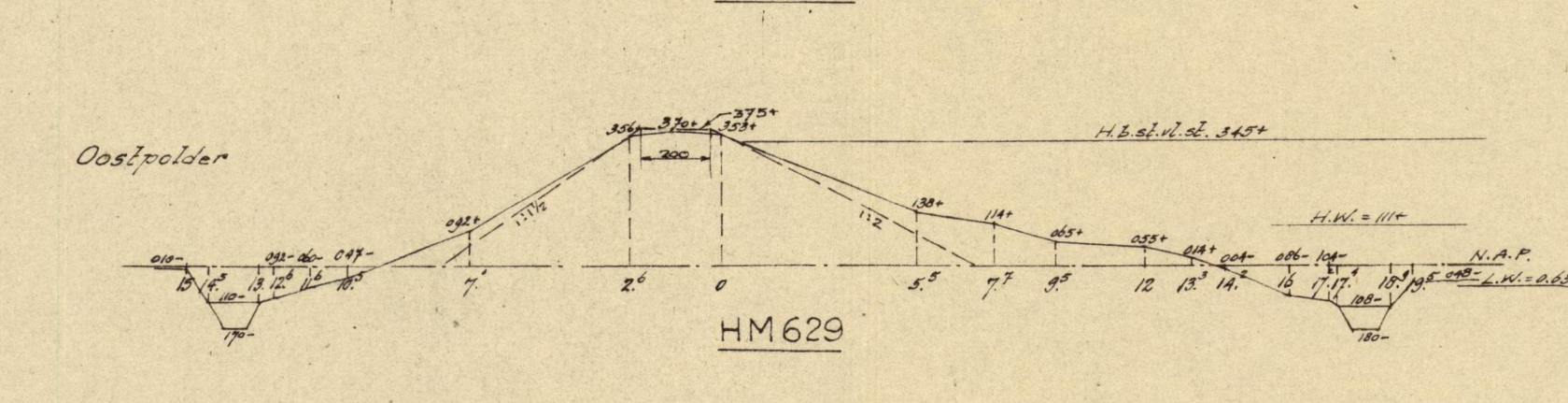
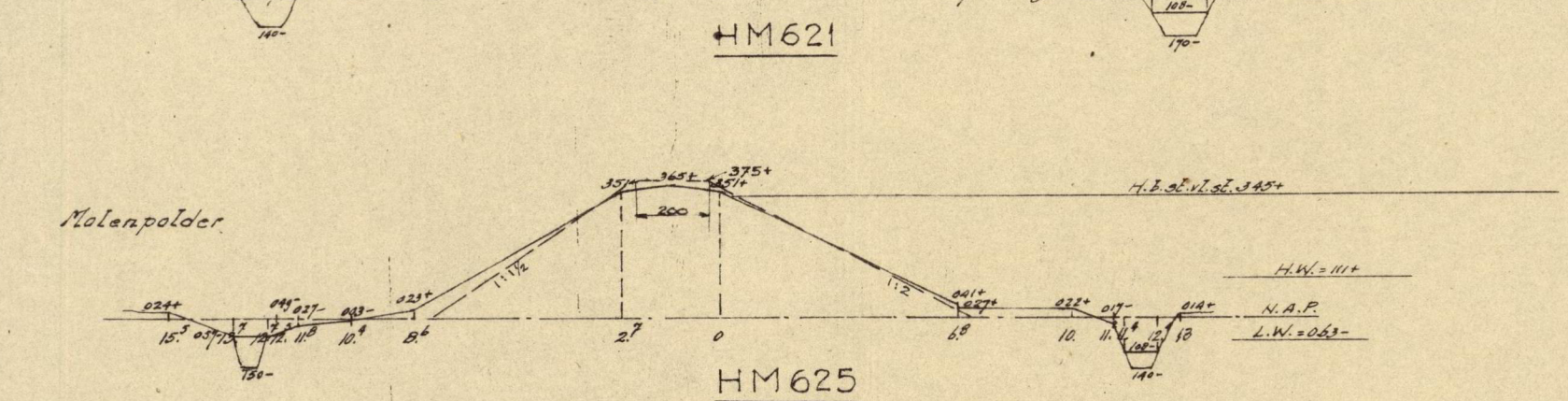
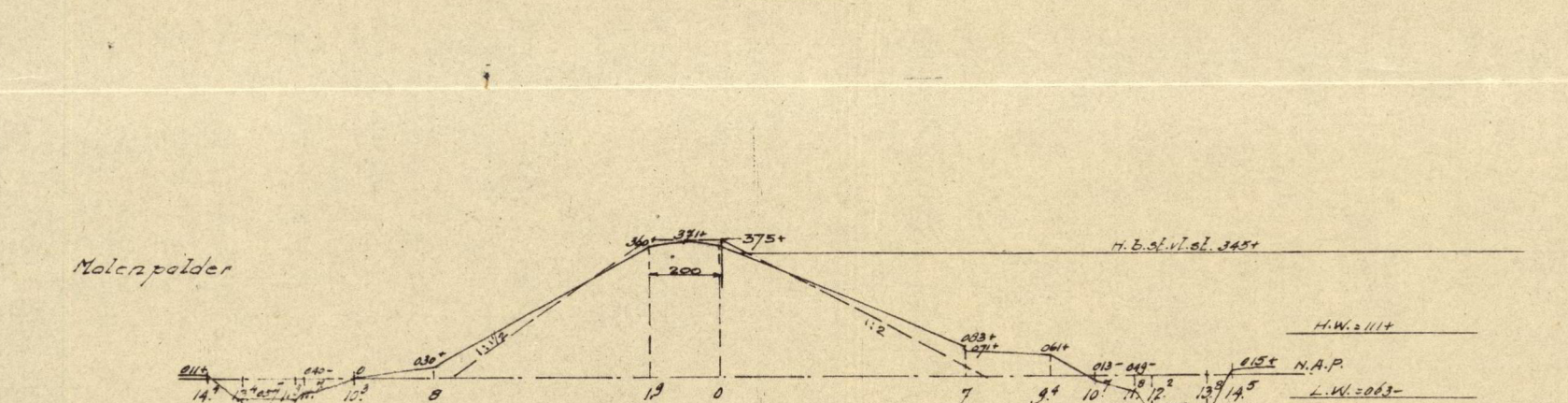
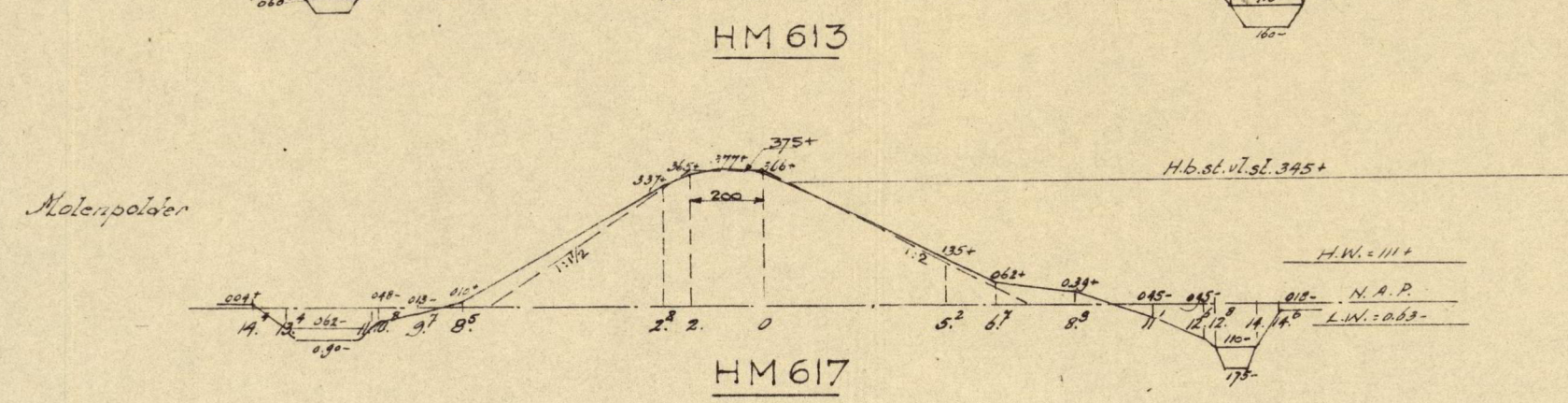
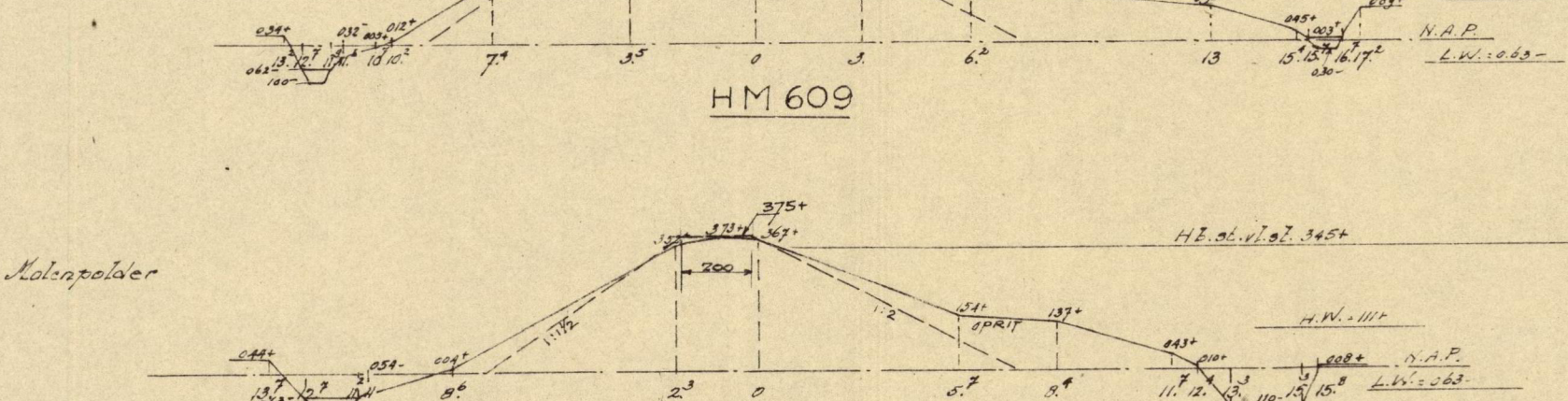

DIJK 1/6 EENDRAGTSPOLDER

DIJKVAK 30

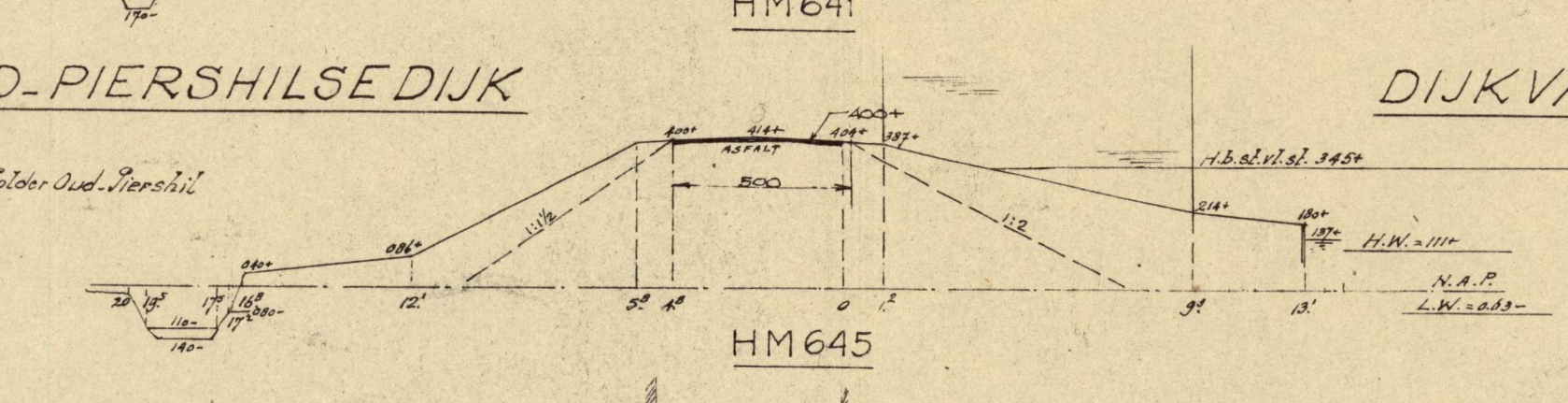

OUD-PIERSHILSE DIJK

DIJKVAK 31

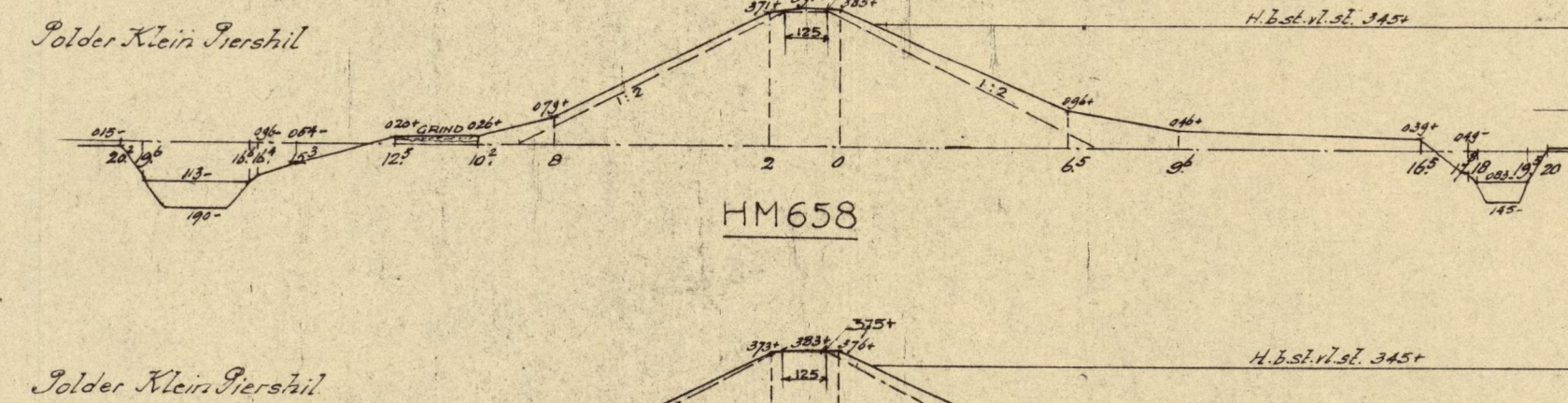
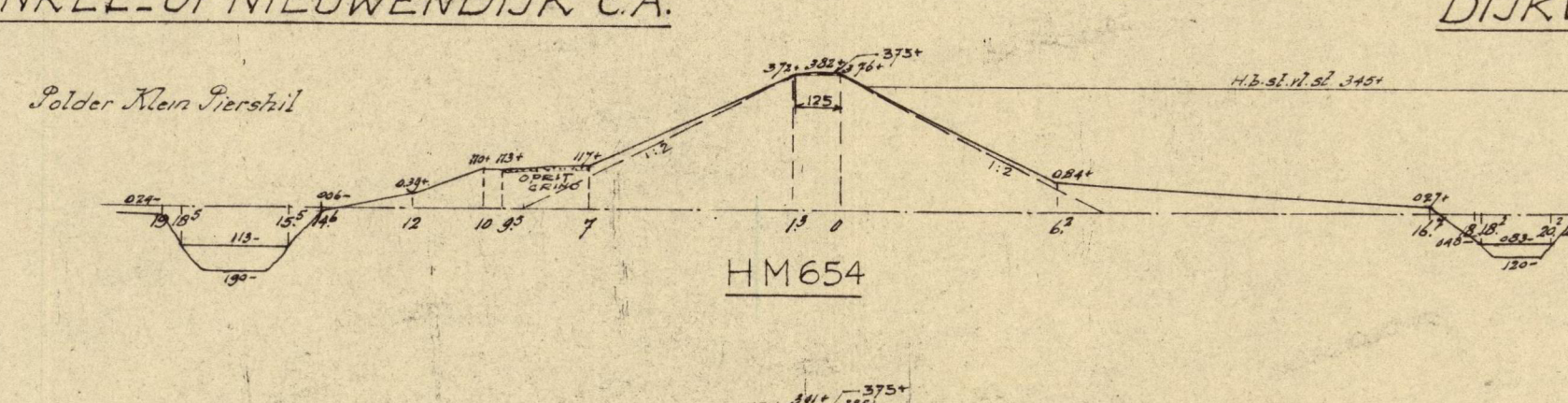
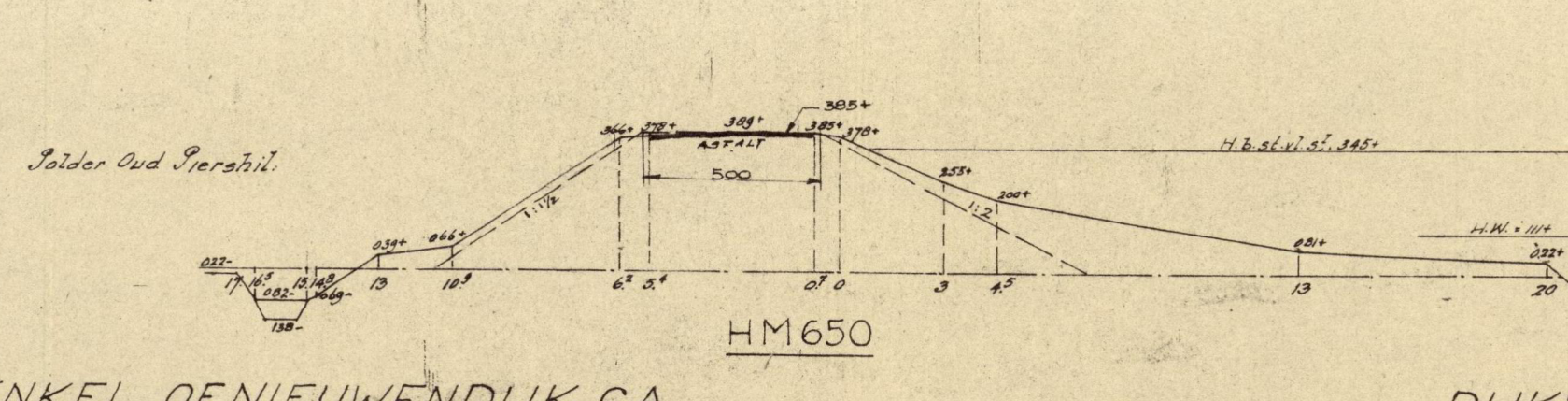
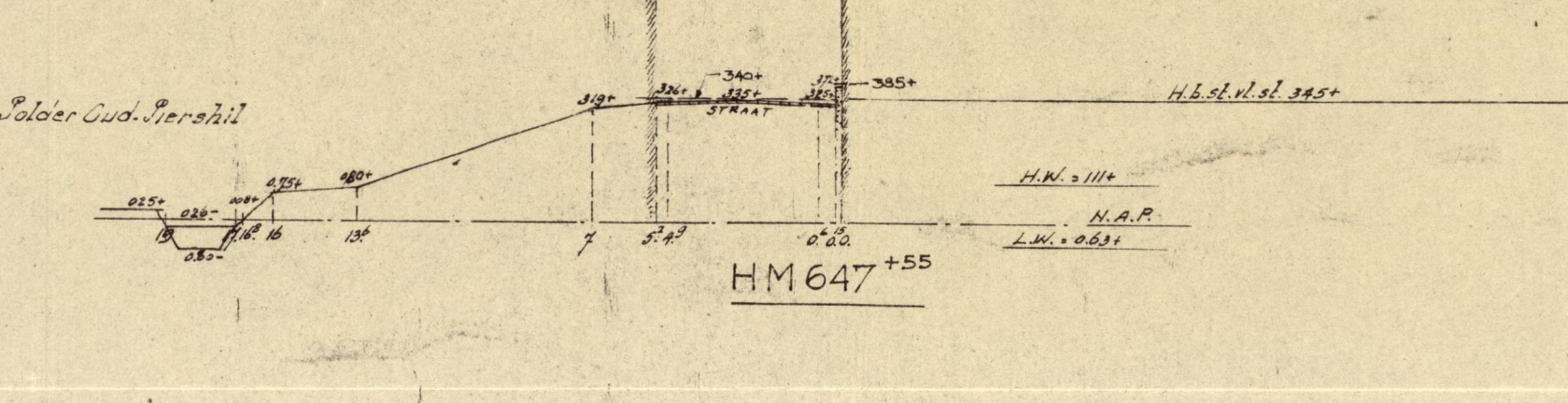

SCHENKEL-OF NIEUWENDIJK C.A.

DIJKVAK 32

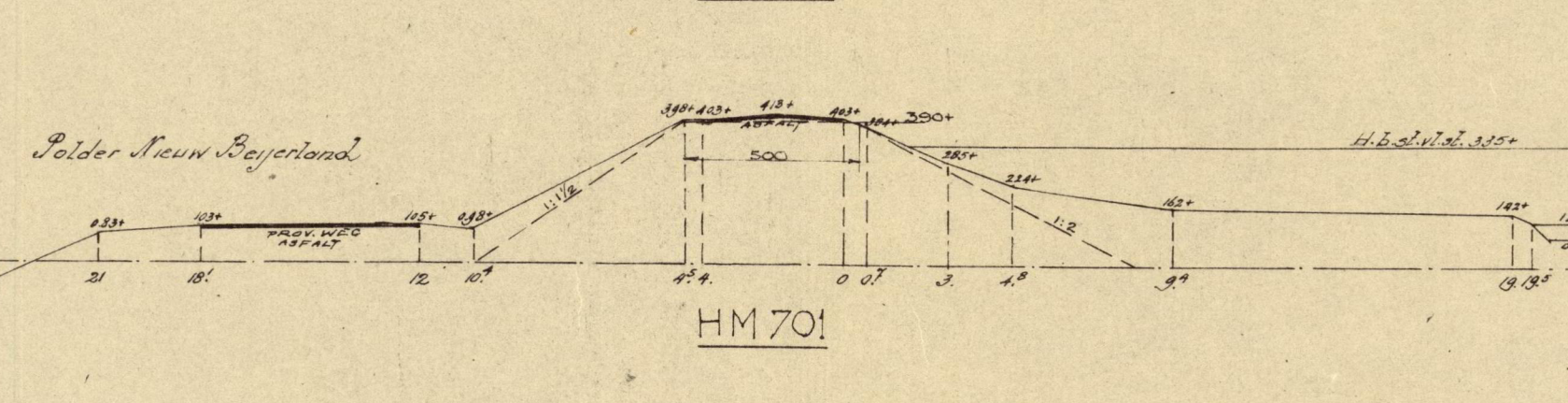
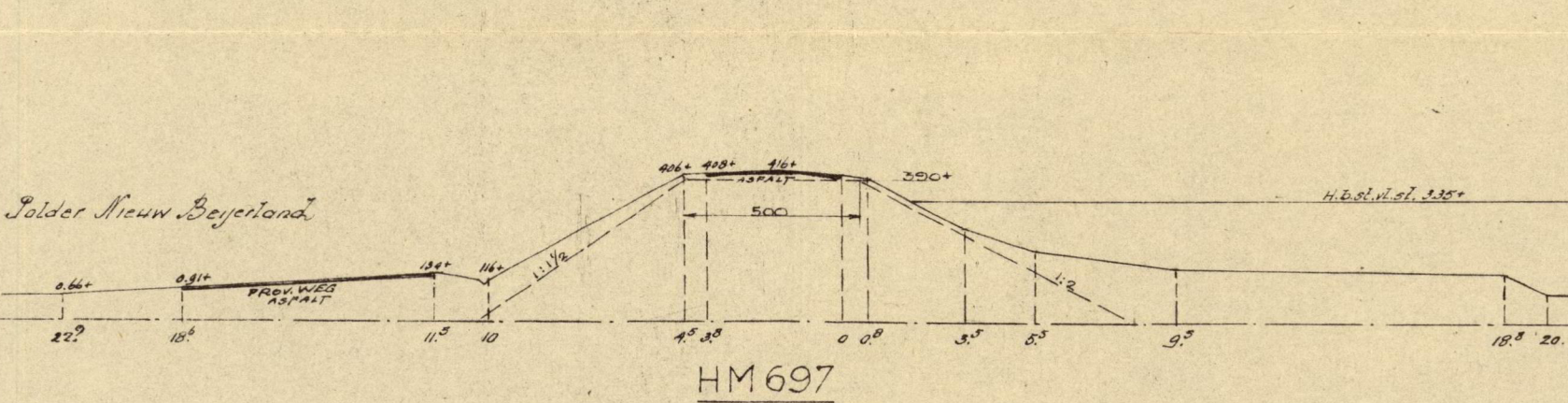
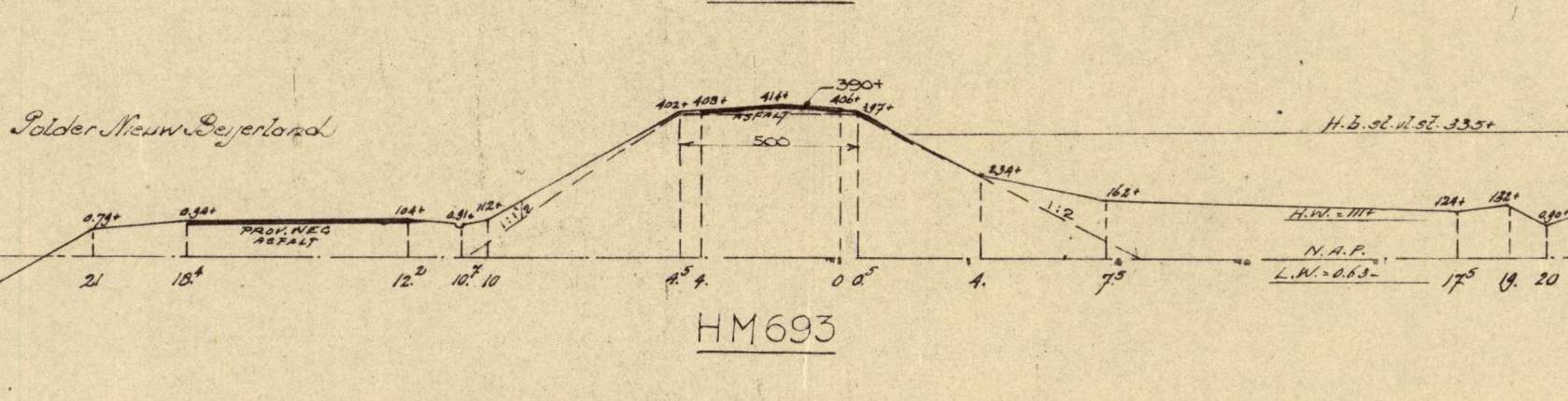
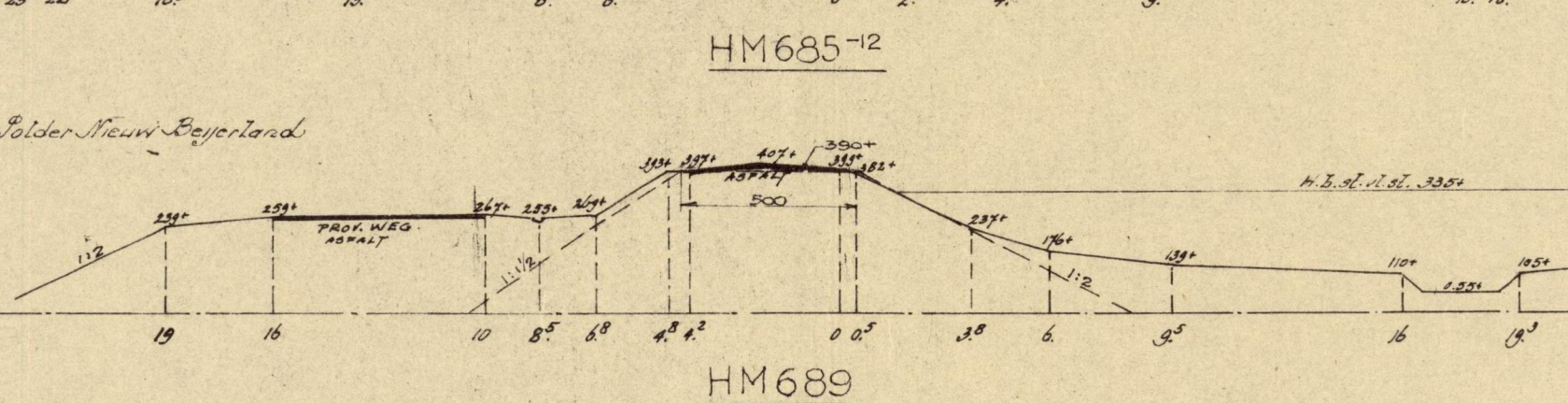
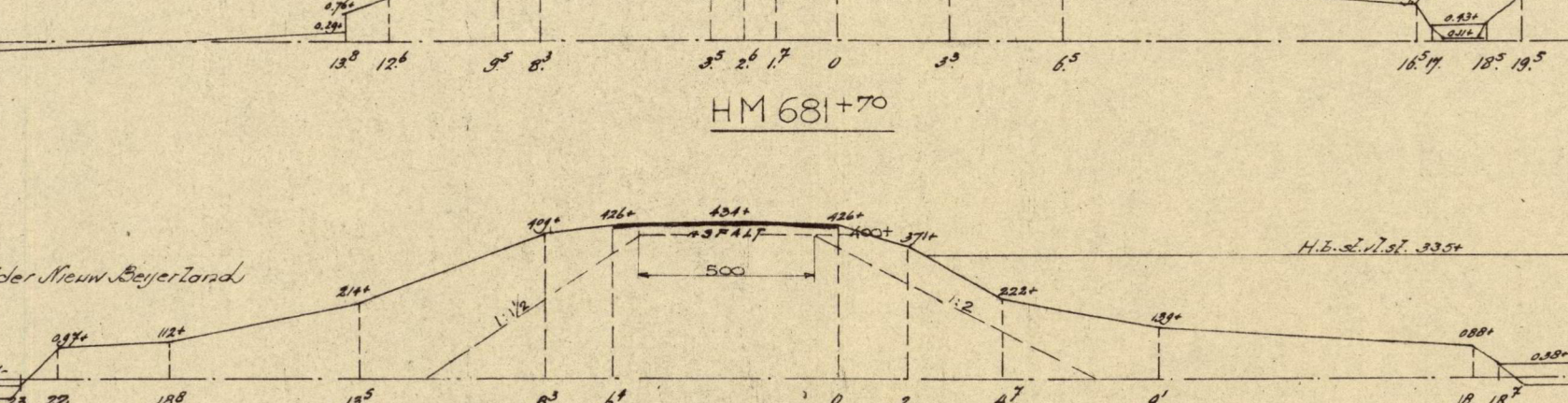
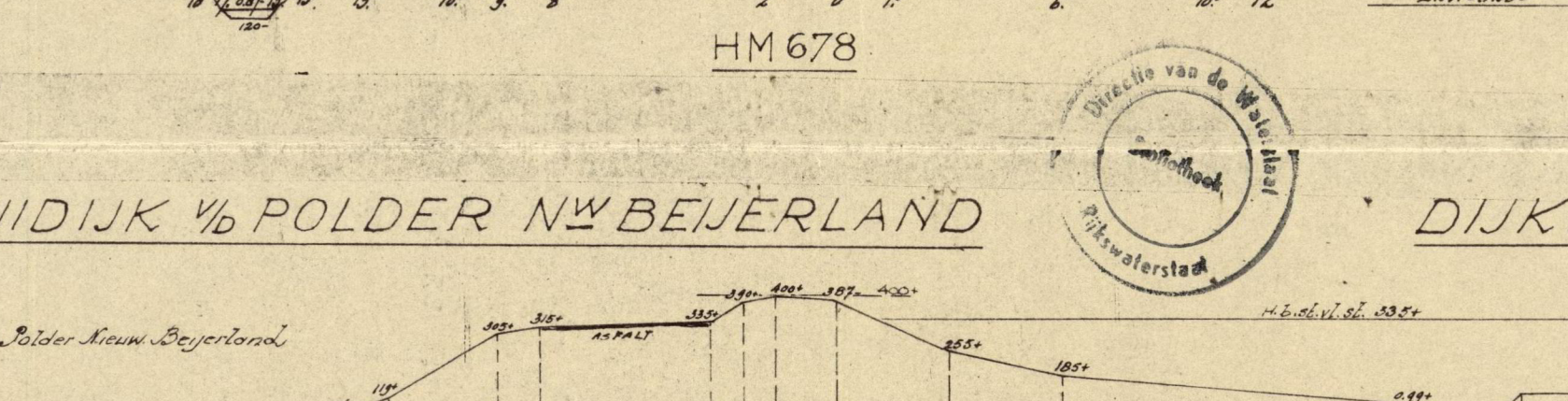
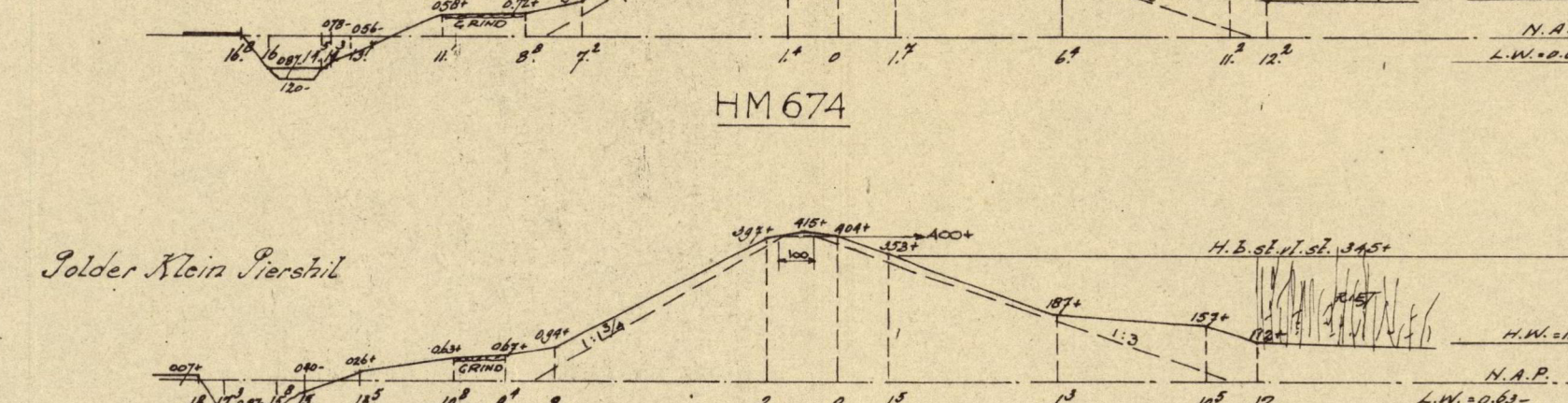
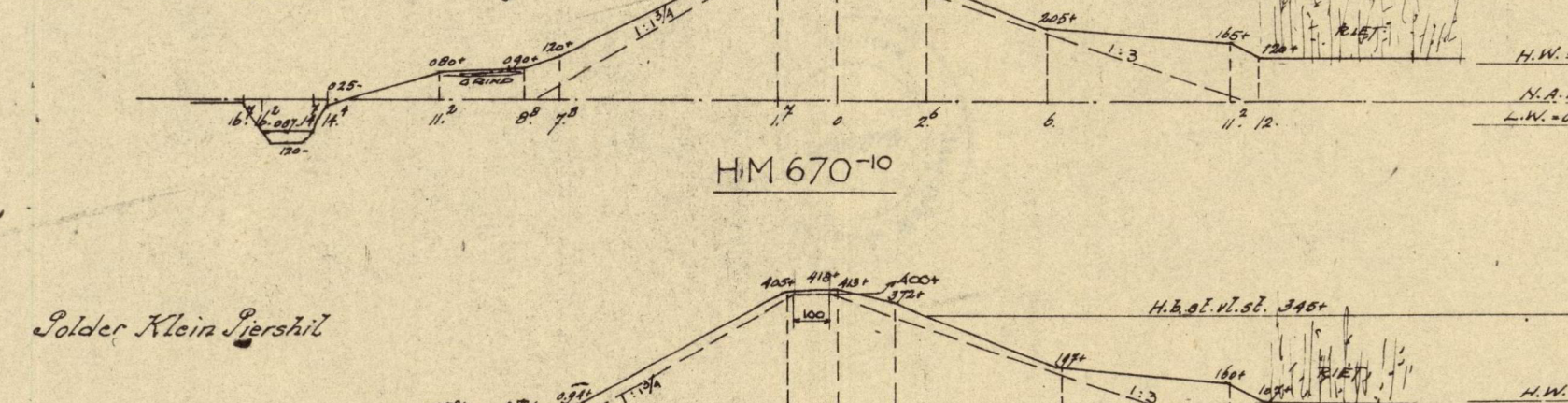
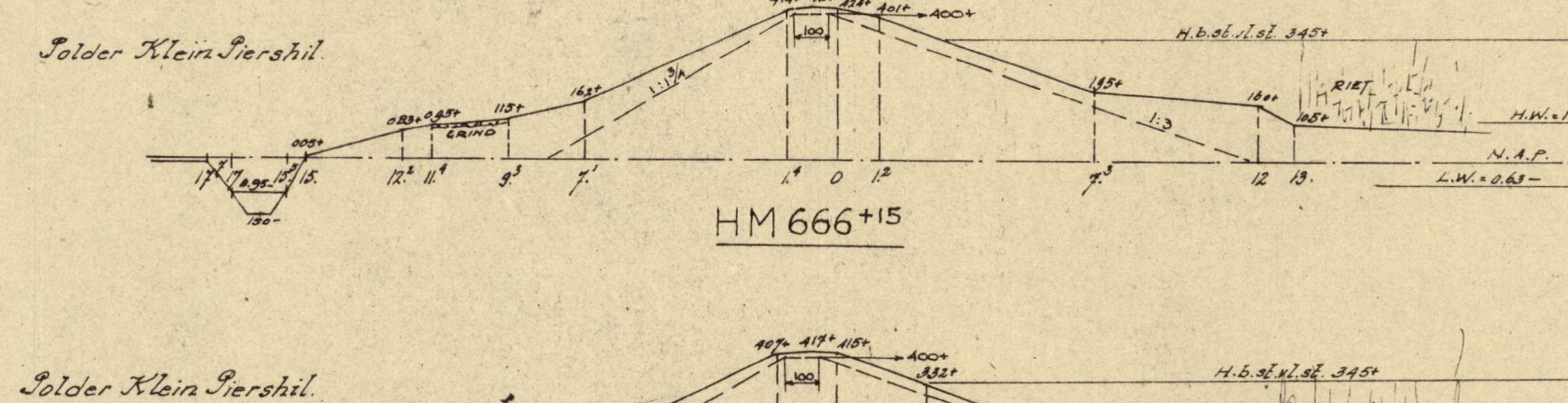
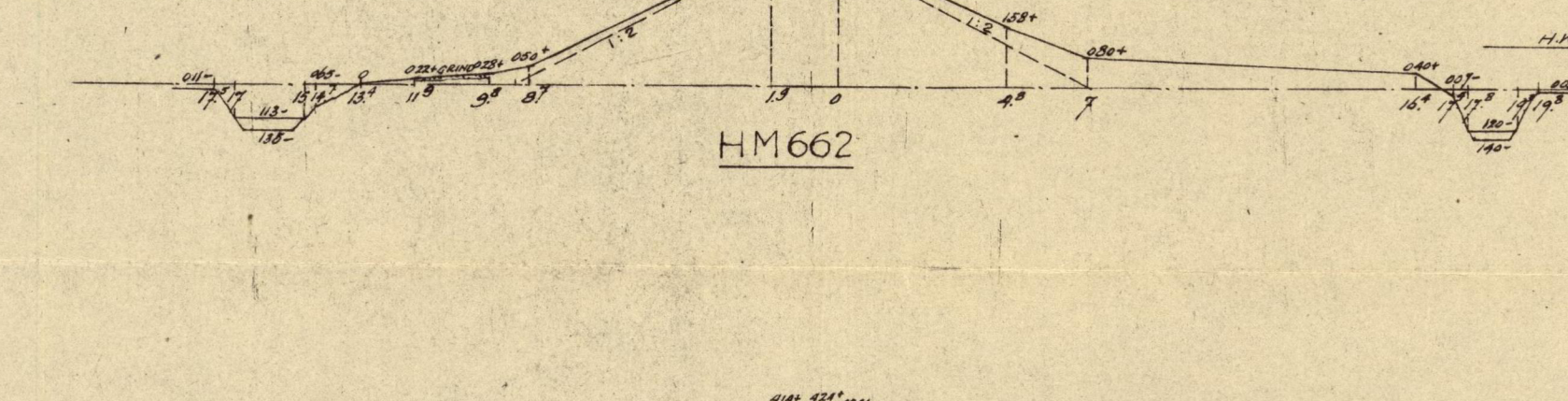

SPUIDIJK 1/6 POLDER NW BEIJERLAND

DIJKVAK 33

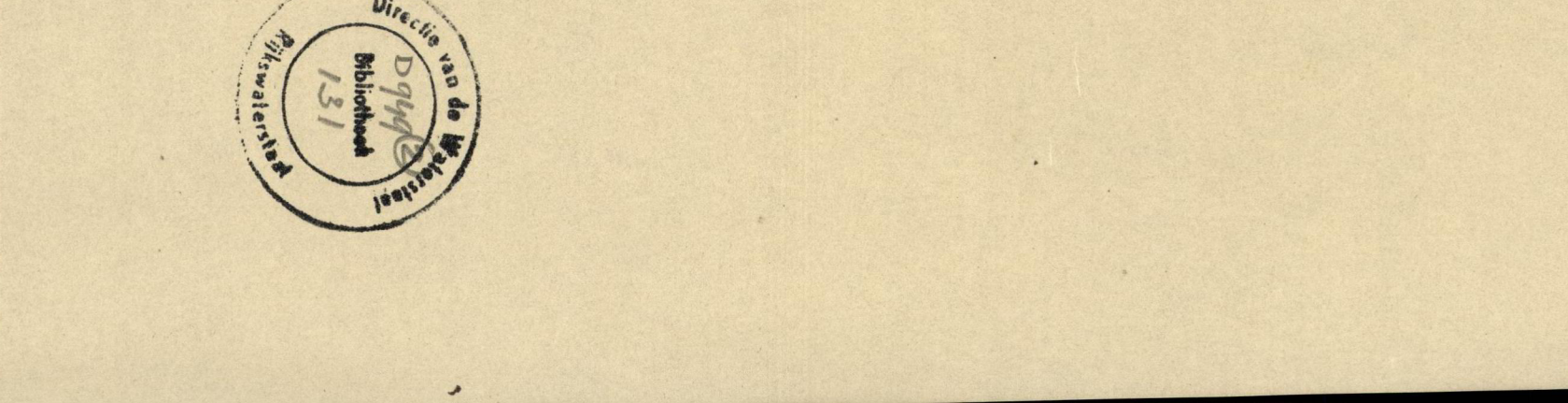
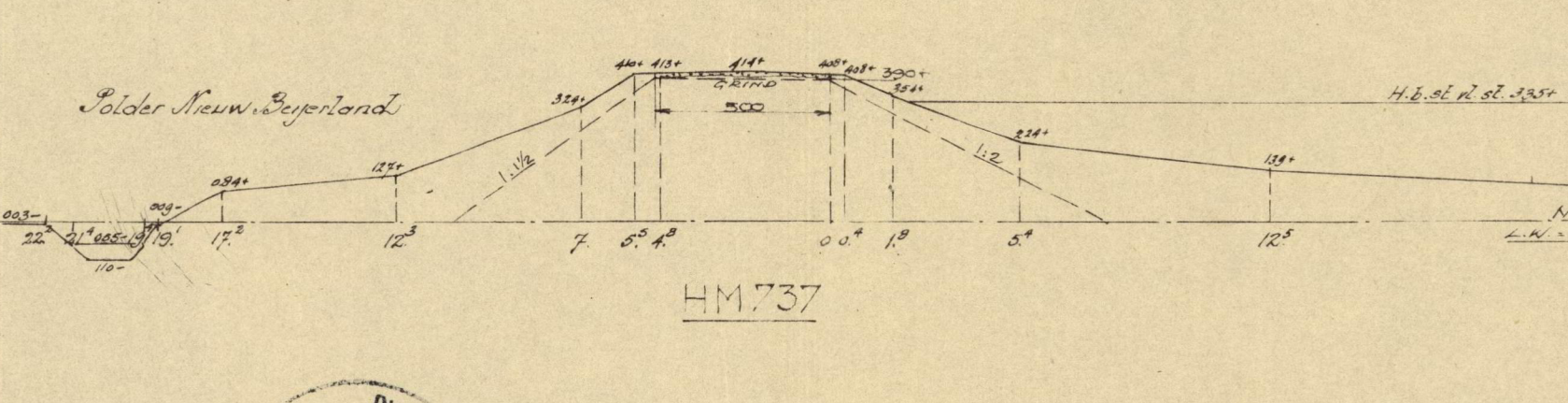
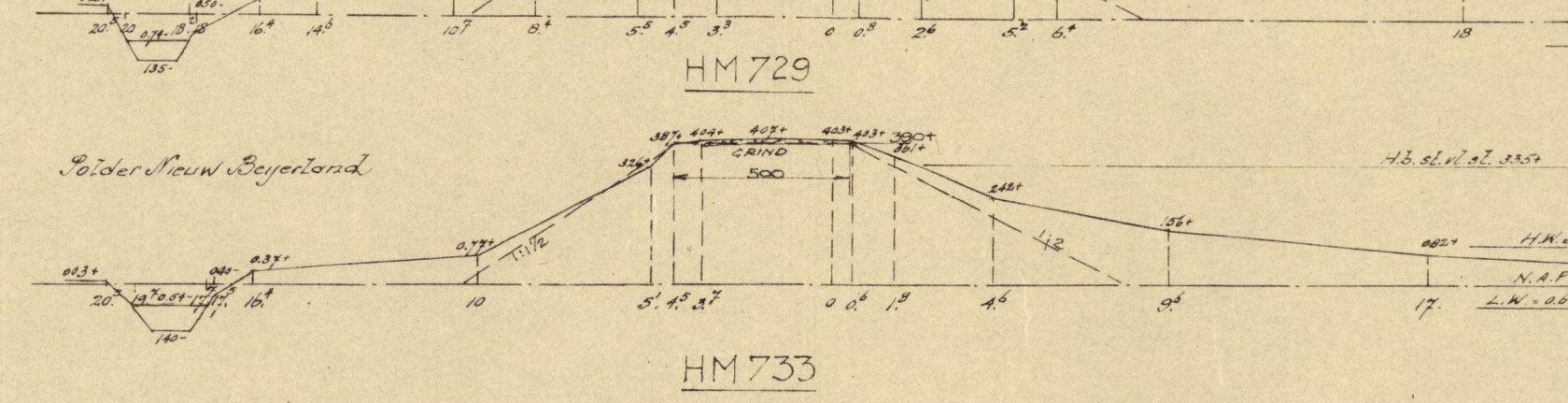
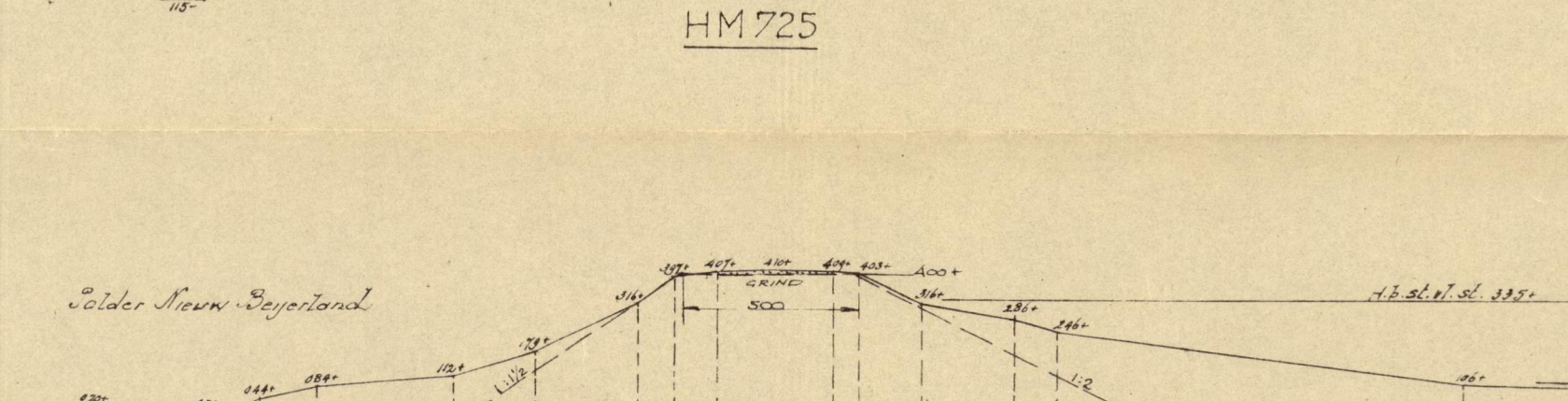
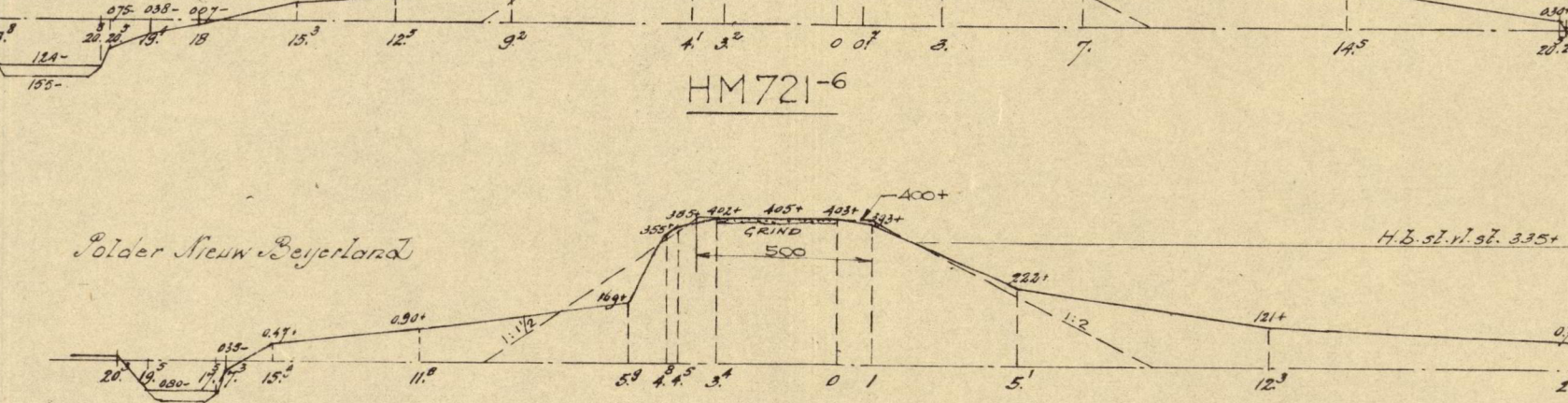
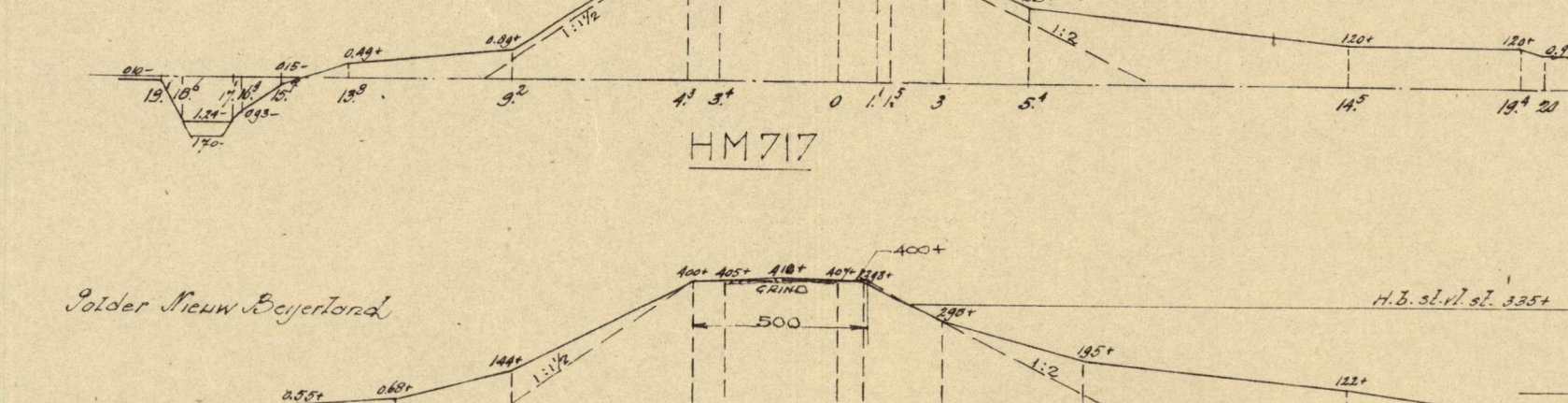
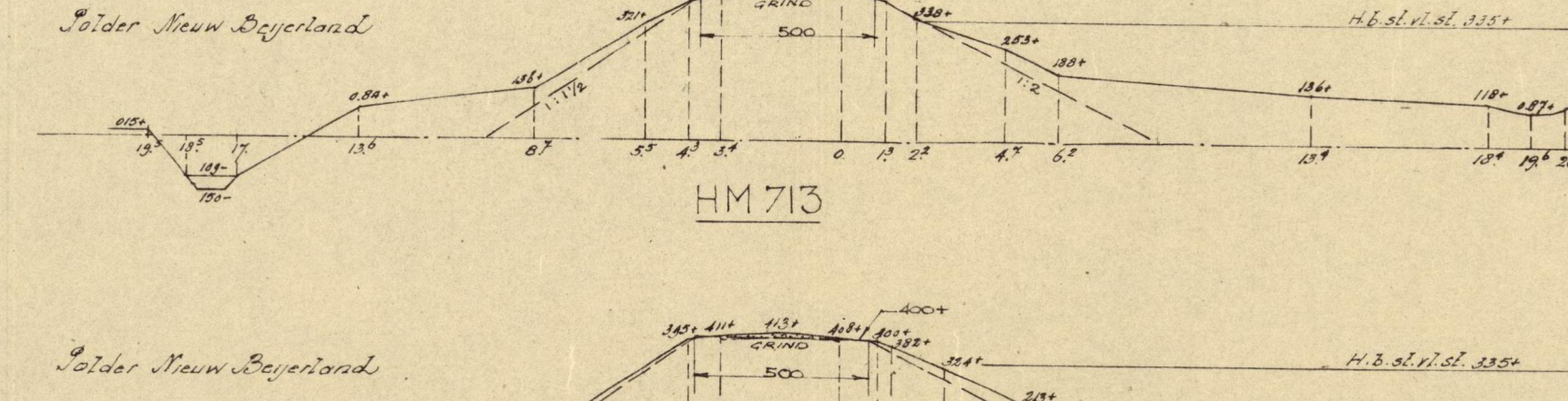
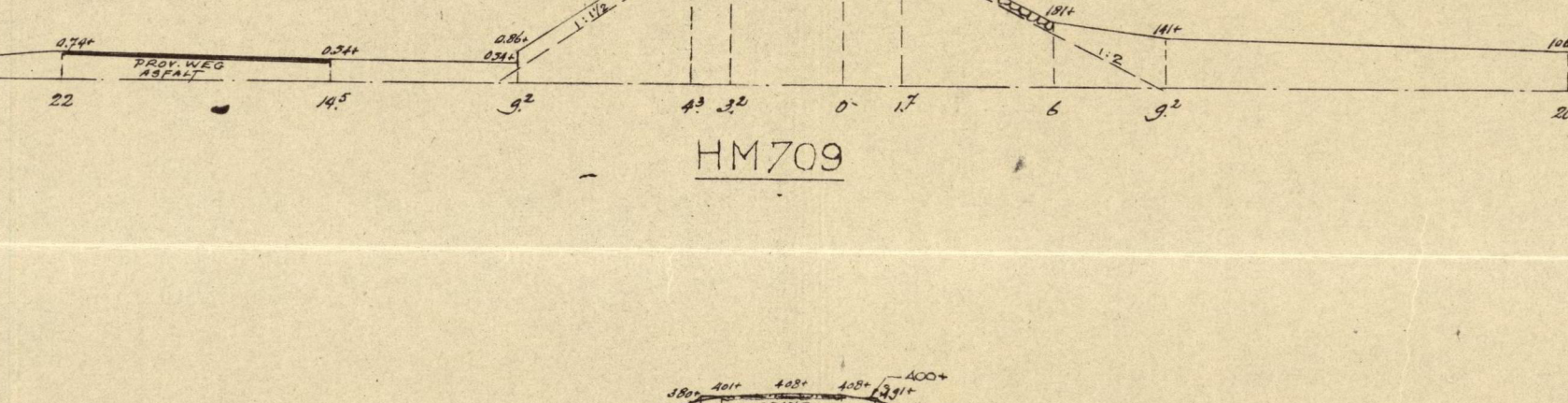
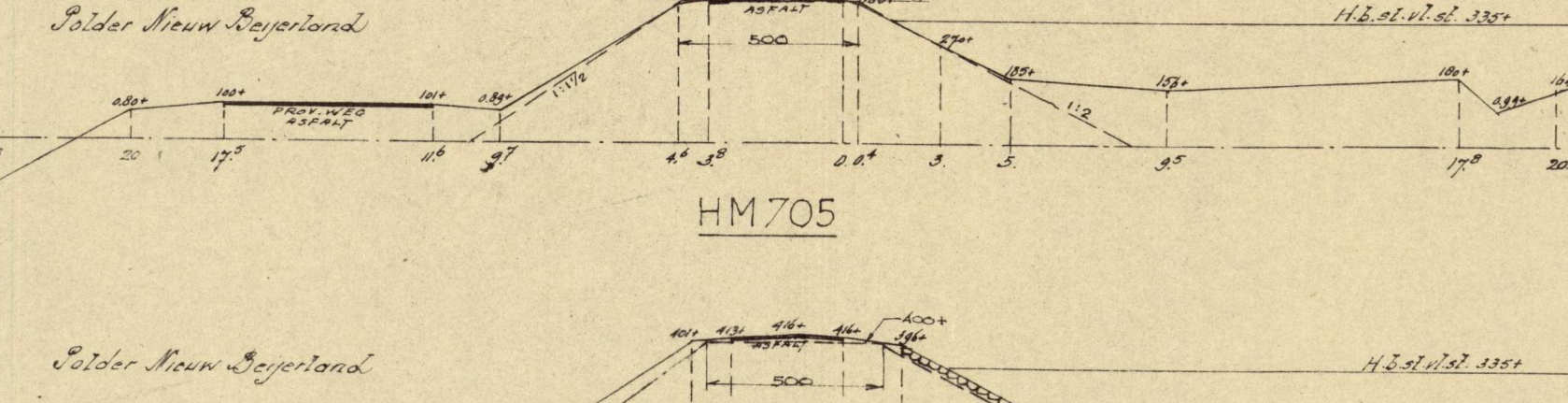
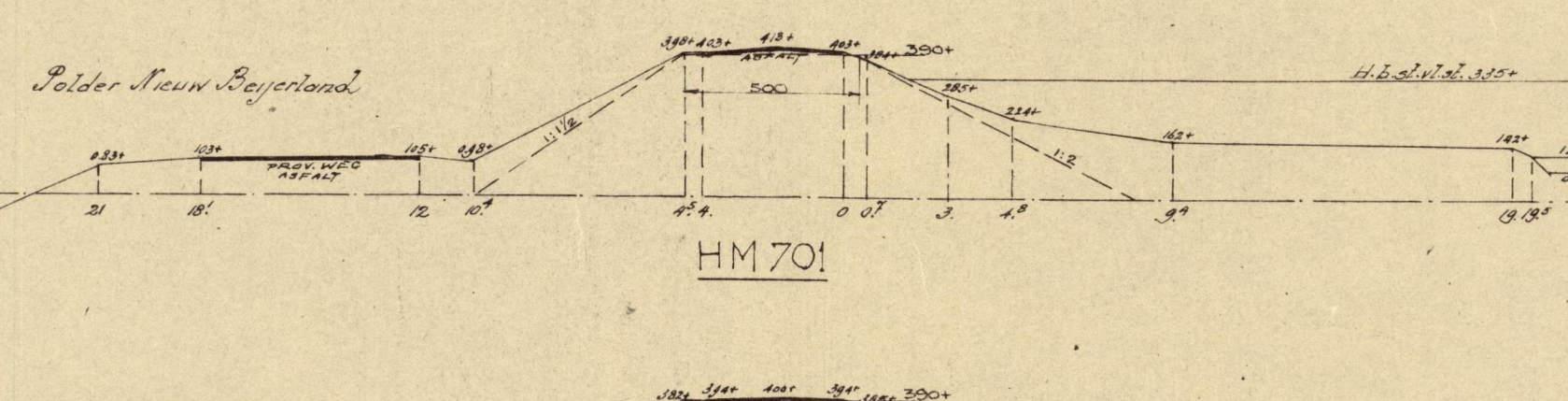
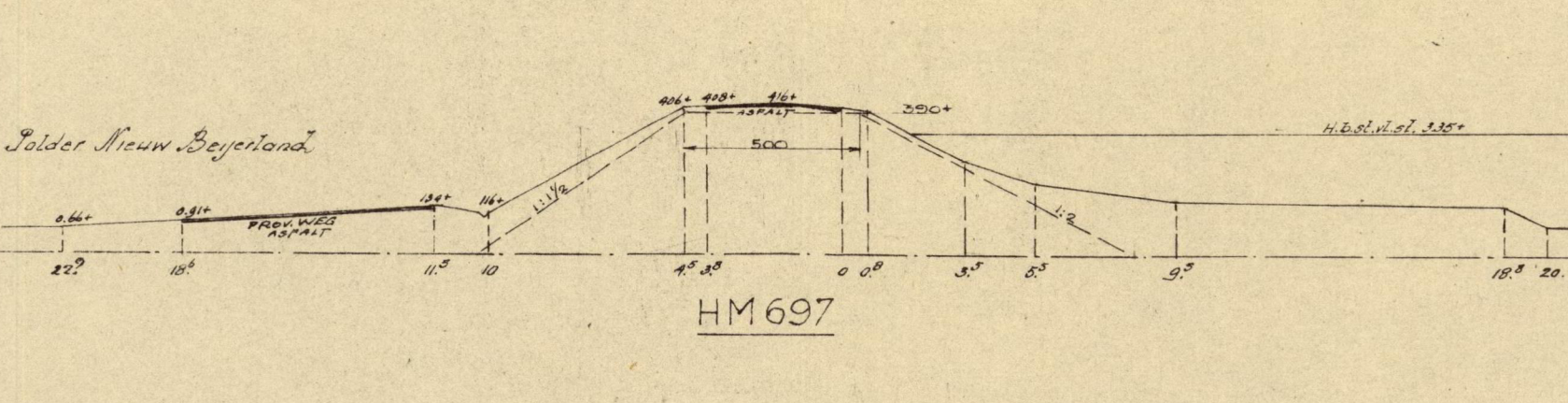
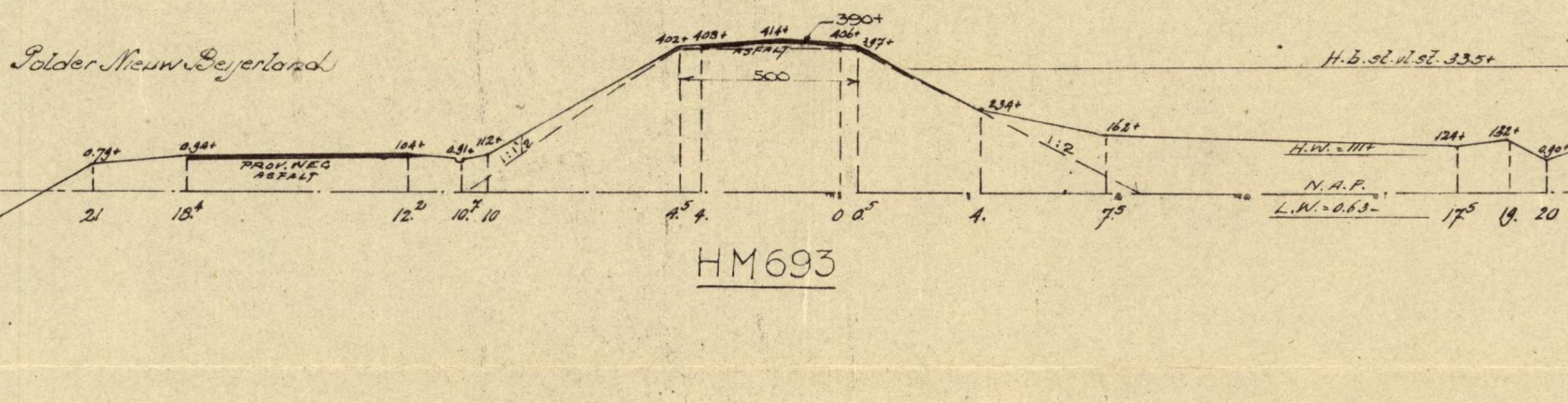
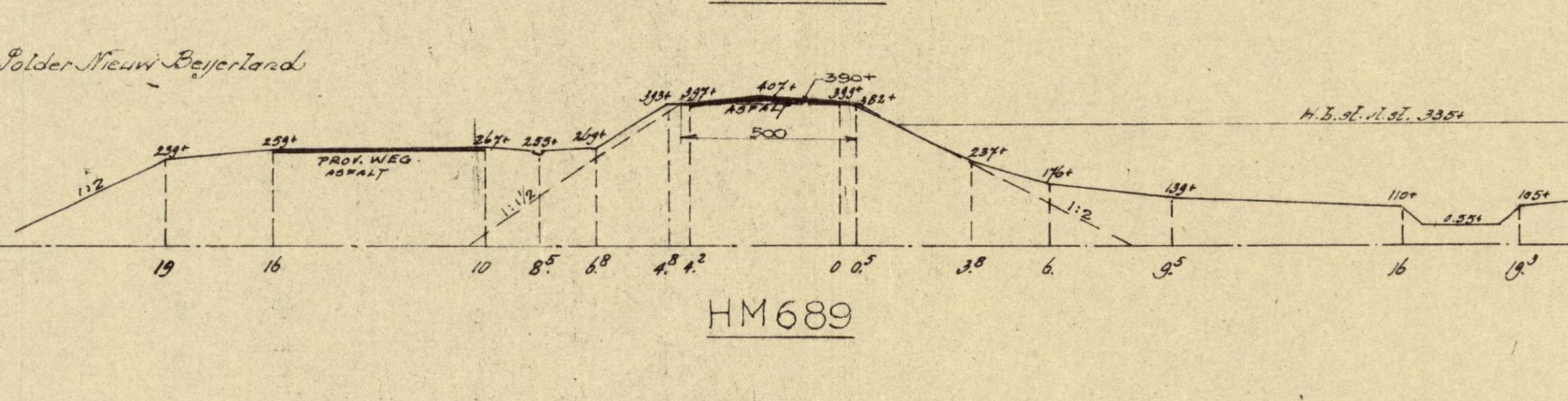
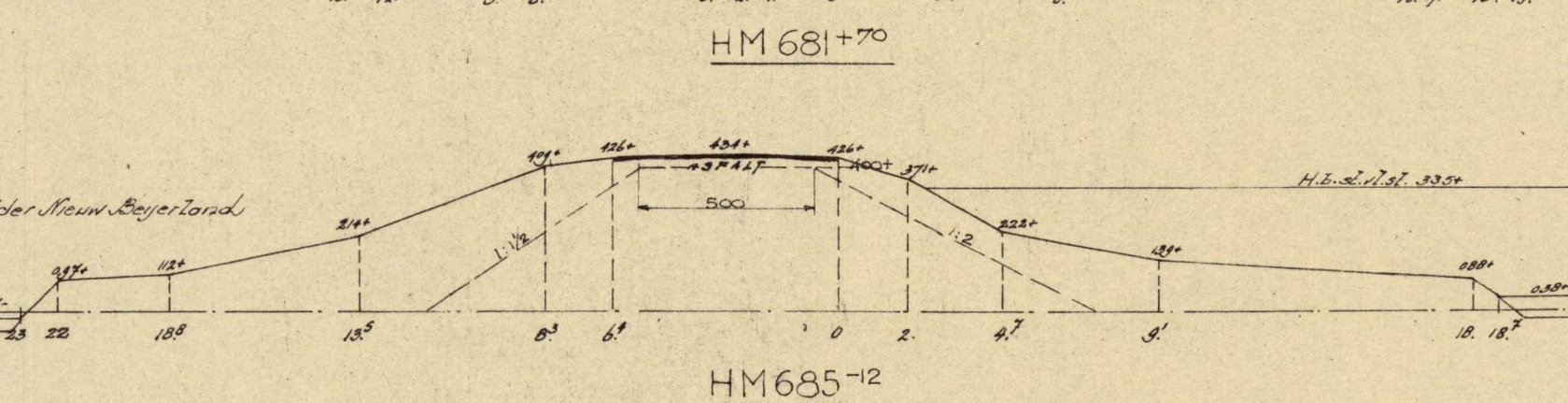
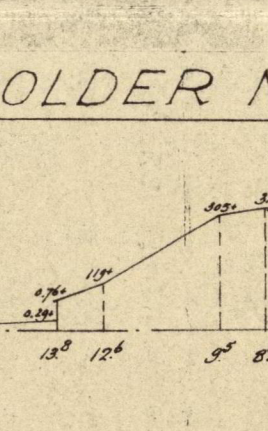

RAPPORT N° 10. 1933
BULAGE H4 BLAD 7
A4
A5 N° 53.879
A4
53.880

